



AGRICULTURAL RESEARCH INSTITUTE

PUSA

The Agricultural Journal of India

EDITED BY

The Agricultural Adviser to the Government of India

VOL. XVIII

(1923)



PUBLISHED FOR

THE IMPERIAL DEPARTMENT OF AGRICULTURE IN INDIA

BY

THACKER, SPINK & CO., CALCUTTA

W. THACKER & CO., 2, CREED LANE, LONDON

PRINTED BY
THACKER, SPINK & CO., CALCUTTA

VOL. XVIII PART I

January, 1923

THE AGRICULTURAL JOURNAL OF INDIA



EDITED BY

The Agricultural Adviser to the Government of India

PUBLISHED FOR

THE IMPERIAL DEPARTMENT OF AGRICULTURE IN INDIA

BY

THACKER, SPINK & CO., CALCUTTA

W. THACKER & CO., 2, CREED LANE, LONDON

Price R. 1-8 or Two Shillings

Agents for the Sale of Government Publications

IN EUROPE

- Constable & Co., 10, Orange Street, Leicester Square, London, W.C.
- Kegan Paul, Trench Trübner & Co., 68-74, Carter Lane, E.C., and 25, Museum Street, London, W.C.
- Bernard Quaritch, 11, Grafton Street, New Bond Street, London, W.
- P. S. King & Sons, 2 & 4, Great Smith Street, Westminster, London, S.W.
- H. S. King & Co., 65, Cornhill, E.C., and 9, Pall Mall, London, W.
- Grindlay & Co., 54, Parliament Street, London, S.W.
- Luzac & Co., 46, Great Russell Street, London, W.C.
- W. Thacker & Co., 2, Creed Lane, London, E.C.
- T. Fisher Unwin, Limited, 1, Adelphi Terrace, London, W.C.
- B. H. Blackwell, 50 & 51, Broad Street, Oxford.
- Deighton, Bell & Co., Ltd., Cambridge.
- Oliver & Boyd, Tweeddale Court, Edinburgh.
- E. Ponsonby, Ltd., 116, Grafton Street, Dublin.
- Ernest Leroux, 28, Rue Bonaparte, Paris.
- Martinus Nijhoff, The Hague, Holland.

IN INDIA AND CEYLON

- Thacker, Spink & Co., Calcutta and Simla.
- W. Newman & Co., Calcutta.
- R. Cambay & Co., Calcutta.
- S. K. Lahiri & Co., Calcutta.
- B. Bannerjee & Co., Calcutta.
- The Indian School Supply Depot, 309, Bow Bazar Street, Calcutta, and 226, Nawabpur, Dacca.
- Butterworth & Co. (India), Ltd., Calcutta.
- Rai M. C. Sarkar Bahadur & Sons, 75-1-1, Harrison Road, Calcutta.
- The Weldon Library, 18-5, Chowringhee Road, Calcutta.
- Standard Literature Co., Ltd., Calcutta.
- Lal Chand & Sons, Calcutta.
- Higginbothams, Ltd., Madras.
- V. Kaliyanarama Iyer & Co., Madras.
- G. A. Natesan & Co., Madras.
- S. Murthy & Co., Madras.
- Thompson & Co., Madras.
- Temple & Co., Madras.
- P. R. Rama Iyer & Co., Madras.
- E. M. Gopalakrishna Kone, Madura.
- Thacker & Co., Ltd., Bombay.
- A. J. Combridge & Co., Bombay.
- D. B. Taraporevala, Sons & Co., Bombay.
- Mrs. Radhabai Atmaram Sagoon, Bombay.
- Sunder Pandurang, Bombay.
- Gopal Narayan & Co., Bombay.
- Ramchandra Govind & Son, Kalbadevi, Bombay.
- A. H. Wheeler & Co., Allahabad, Calcutta and Bombay.
- N. B. Mathur, Superintendent, Nazir Kanun-i-Hind Press, Allahabad.
- Rai Sahib M. Gulab Singh & Sons, Mufid-i-Am Press, Lahore.
- A. Chand & Co., Lahore, Punjab.
- Ram Krishna & Sons, Lahore.
- Superintendent, American Baptist Mission Press, Rangoon.
- Manager, the "Hitavada," Nagpur.
- S. C. Talukdar, Proprietor, Students & Co., Cooch Behar.
- A. M. & J. Ferguson, Colombo, Ceylon.
- Manager, Educational Book Depôts, Nagpur and Jubbul'pore.*
- Manager of the Imperial Book Depot, 63, Chandney Chauk Street, Delhi.*
- Manager, "The Agra Medical Hall and Co-operative Association, Ltd." (Successors to A. John & Co., Agra).*
- Superintendent, Basel Mission Book and Tract Depository, Mangalore.*
- P. Varadachary & Co., Madras.*
- H. Liddell, Printer, etc., 7, South Road, Allahabad.*
- D. C. Anand & Sons, Peshawar.*
- Ram Dayal Agarwala, 184, Katra, Allahabad.*
- Manager, Newal Kishore Press, Lucknow.*

* Agents for the sale of Legislative Department Publications only.

CONTENTS

(VOL. XVIII, PART I)

ORIGINAL ARTICLES

	PAGE
SOME COMMON INDIAN BIRDS. No. 19. THE COMMON INDIAN BEE-EATER (<i>Merops orien- talis orientalis</i>)	T. B a i n b r i g g e <i>Fletcher, R.N., F.L.S., F.E.S., F.Z.S. ; and C.M. Inglis, M.B.O.U., F.E.S., F.Z.S. ..</i>
HUGH CHARLES SAMPSON, ESQ., C.I.E., B.Sc. : AN APPRECIATION	6
THE TREND OF AGRICULTURAL DEVELOPMENT IN THE UNITED PROVINCES	H. M. Leake, Sc.D. 10
TRACTOR CULTIVATION AT LYALLPUR, PUNJAB ..	H. R. Stewart, A. R. C. Sc. I., D.I.C., N.D.A. ; and D. P. John- ston, A.R.C.Sc.I., N.D.A. .. 23
BACTERIAL INFECTION OF COTTON BOLLS ..	Edward Ballard, B.A., F.E.S. ; and Dorothy Norris, M.Sc., A.I.C. .. 40
SOME INSECTS NOTED AS PESTS OF FRUIT TREES IN SOUTH INDIA	T. V. Ramakrishna Ayyar, B.A., F.E.S., F.Z.S. .. 50

SELECTED ARTICLES

✓ THE CLASSIFICATION OF SUGARCANE VARIETIES	60
NEW WATER SELF-RAISER	67

	PAGE
CO-OPERATIVE MARKETING OF COTTON	73
VITAMINS	77
NOTES	
STATISTICS OF THE MILK-SUPPLY OF BOMBAY CITY	80
TESTING COTTON FIBRES FOR STRENGTH	81
THE FORMATION OF SUGAR AND THE RIPENING OF SUGARCANE	82
BRITISH MILKING RECORDS	84
AGRICULTURAL DEVELOPMENT IN THE CAMEROONS	85
APPARATUS FOR STAPLE DIAGRAMS	86
COTTON RESEARCH	88
PERSONAL NOTES, APPOINTMENTS AND TRANSFERS, MEETINGS AND CONFERENCES, ETC.	
	90
REVIEWS	
THE COCCIDÆ OF CEYLON	93
THE FEEDING OF DAIRY CATTLE	94
THE INTERNATIONAL COTTON BULLETIN	94
THE JOURNAL OF THE TEXTILE INSTITUTE	95
NEW BOOKS ON AGRICULTURE AND ALLIED SUBJECTS	96

LIST OF ILLUSTRATIONS.

The Common Indian Bee-eater (<i>Merops orientalis orientalis</i>)	Frontispiece
Plate I. Hugh Charles Sampson, C.I.E., B.Sc.	Facing page 6

**The following Original Articles will appear in our next issue
(March 1923).**

- SOME COMMON INDIAN BIRDS. NO. 20. THE
BENGAL JUNGLE-BABBLER OR "SEVEN
SISTERS" *T. Bainbrigge Fletcher,*
R.N., F.L.S., F.E.S.,
F.Z.S. ; and C. M. Inglis,
M.B.O.U., F.E.S., F.Z.S.
- SOME ASPECTS OF AGRICULTURAL MARKETING
AS ILLUSTRATED BY THE LYALLPUR CO-
OPERATIVE COMMISSION SALE SHOPS .. *H. K. Trevaskis, O.B.E.,*
I.C.S.
- EXPERIMENTS ON THE GREEN-MANURING OF
RICE *C. Somers Taylor, B.A. ;*
and Manmathanath Ghosh,
M.A.
- A PRELIMINARY ACCOUNT OF SYMBIOTIC
NITROGEN FIXATION IN NON-LEGUMINOUS
PLANTS WITH SPECIAL REFERENCE TO
Chomelia asiatica *K. Adinarayan Rao,*
L.Ag.
- A NEW PLANT FOR INDIA *K. Kunhikannan, M.A.,*
Ph.D., F.E.S



THE COMMON INDIAN BEE-EATER (*MEROPS ORIENTALIS ORIENTALIS*.)



HUGH CHARLES SAMPSON, C.I.E., B Sc.

No member of the Service has had wider experience than Mr. Sampson. He was at different times in charge of the IV, V, VI, VII, and VIII Circles, covering a wide area of the Presidency, many different types of crops and agricultural practices. He acted as Principal of the Agricultural College, Coimbatore, from April to November in 1913 and as Director twice. During this varied career his name was associated with most of the activities of the department and he was directly responsible for many new ventures.

He was occupied for many years with cotton improvement, and as soon as he took charge of a district a distinct change for the better appeared in its cotton crop. His work with Tinnevely and "Company" cottons is well known, and his name will always be associated with the introduction and spread of Cambodia cotton. When he was transferred to Coimbatore he opened a farm for the special study of the latter cotton at Anamalai, and he was responsible for the establishment of a local cotton market with buying standards at Tiruppur. He had much to do with the introduction and enforcement of the Pest Act in the Coimbatore District to protect Cambodia cotton from the ravages of the boll and stem weevils.

He was responsible for an organized campaign for the distribution of a special manure mixture in the Tanjore delta. This mixture was based on the results of the soil survey of this tract, and it had been tried out and found a success on one of the farms. It was distributed to over 500 individuals in 300 villages under agreement that it was to be applied under departmental instructions and that the department was to be allowed to harvest and record the yields obtained, and the owner undertook to purchase sufficient of the manure for 10 acres the following year if he was satisfied with the results.

In 1911-12 he was placed on special duty to make a survey of the cattle of the Presidency, a most important piece of work which he carried out with characteristic thoroughness. Out of this has arisen the appointment of a Live-stock Expert and a series of cattle-breeding projects for the betterment of the stock in general and the milk supply in particular.

The introduction and popularizing of fish manure among the ryots was largely due to Mr. Sampson's efforts, and he did much to extend the system of green-manuring which has now been adopted over very large areas and is one of the chief items of the department's demonstration propaganda. Always jealous of the interests of the farmer he took an active part in the attempt which was made by Madras to persuade the Government of India to introduce legislation to stop or control the drain on the indigenous manures from the country by the export of bones, fish, and oil-cakes.

His last big piece of work was begun when he returned to the West Coast in 1918. He then took up the study of coconuts and established three farms for their cultivation on improved lines. On these farms improved methods of planting and cultivation have been demonstrated and the benefits of manuring shown. With the aid of the Government Agricultural Chemist he undertook an exhaustive study of the chemical composition of the plant and the distribution of the plant foods in it at all stages of its development. He also made a detailed study of the root development and the method of flowering and fertilization. The manufacture of *jaggery* from the juice was taken up and improvements rapidly introduced. This exhaustive study has revealed several quite new points, and Mr. Sampson is shortly publishing a book on the subject which will be of the greatest value to all coconut growers.

In 1920 he made a tour in Cochin China and Cambodia, on deputation for the Government, to study the coconut and cotton cultivation in those countries. On his way back he visited the Federated Malay States and Ceylon. In his usual way he managed to see a great deal in a very short time, and he published an excellent account of his trip in the "Madras Year-Book," 1920.

Always interested in rural education he was, in 1918, a member of a committee appointed to discuss this subject with the Education Department. The result has been the starting, as an experiment, of two agricultural middle schools, and one of the last things he did before his retirement was to open one of these at Taliparamba.

Mr. Sampson acted as Director of Agriculture in 1912 and again from September 1921 till August 1922, the date of his retire-

ment. As Director his task was by no means a light one. He assumed the reins of office under difficult circumstances, following the sudden death of Mr. Stuart, but he was the right man in the right place. He already had the confidence and affection of his colleagues and his long and varied experience enabled him to very rapidly get the department working smoothly again and with the utmost efficiency.

Hugh Sampson possesses a large number of friends, both inside and outside the Agricultural Department, and many members of that department, both European and Indian, have reasons to be grateful to him for help and advice, and they will watch his career in Africa, for he has returned to his first love, with jealous eyes, well knowing that he will soon set his mark on the cotton improvement in that country. Of a retiring disposition Sampson never put himself forward or claimed credit due to another, in fact seldom claimed credit due to himself. It was with the greatest pleasure, therefore, that his many friends saw him decorated with the C.I.E. in 1921. His severance from the department will be greatly felt, not only in Madras, but also at Pusa, where his tall lean figure will be missed from the Board of Agriculture meetings as well as his sardonic humour and one and only song. That the Madras Agricultural Department have lost in him one of the most capable officers they have ever had is undoubted. In the Administration Report of the department for 1918-19 it was said of him, "Mr. Sampson's work stands in a class by itself both from its technical excellence and its practical value ; there can be few people who have ever left India who can say they have put so much money into the country as Mr. Sampson has." A well-earned tribute which any man may be proud of. [R. D. A.]

THE TREND OF AGRICULTURAL DEVELOPMENT IN THE UNITED PROVINCES.

BY

H. M. LEAKE, Sc.D.,

Director of Agriculture, United Provinces

IT would be a commonplace to say that the factor dominating the agriculture of the United Provinces is the monsoon ; the proposition is self-evident. When, however, an attempt is made to measure that dominance the problem is no easy one. Still more difficult is it to describe that measure of dominance in non-technical language. I shall make no such attempt ; rather will I explain that technical language by a homely illustration.

If I throw a ball it can be said that the harder I throw the greater the distance the ball will go. There is here a direct relation between the strength I exert and the distance the ball travels and the fact is expressed by what is termed the correlation coefficient, or r , which is here = $+1$. If, however, I throw with the same strength but use a ball of different weight each time, as long as extremes are not included, the distance each ball travels will bear a direct relation to its weight but the lightest ball will go furthest and the heaviest ball the least distance. Here distance is directly correlated with lack of weight and inversely with actual weight. This fact is again expressed by the correlation coefficient but with a change of sign and the equation becomes $r = -1$. If again I throw a ball against another man, turn for turn, the distance his ball travels is dependent only on the strength he exerts and no relation exists between the strength I exert each time and the distance his ball travels. Again this fact is expressible by the correlation coefficient and is given by the expression $r = 0$. Lastly, if I throw a ball against a gusty wind

the distance travelled will depend not only on the strength used but on the strength of the wind. The correlation coefficient between the strength I exert and the distance travelled in this case will be between 0 and + 1 and the magnitude of r is an expression of the relative influence of the strength I exert and the wind. If the wind be light and fairly steady the value of r will be large and nearly 1, if it be strong and very gusty r will be small, approaching 0. It is not here necessary to enter into the technical method of calculating the value of r in any particular case; my object is merely to indicate the meaning of, and the importance to be attached to, such a figure.

In the course of an investigation I have recently undertaken, details of which I hope to publish shortly, I have had reason to attempt the measure of the extent of the dependence of the agriculture of the province on the monsoon and I have used the correlation coefficient, as just described, as an indication of that measure. An instance or two will suffice to make the point I desire to bring out clear. For the relation between unirrigated wheat area and the previous monsoon r has been found to have a value of over + 0.8, while for the relation between the unirrigated cotton area and the early rainfall r has been found to have as high a value as + 0.87. These figures for r are high and, inasmuch as they give a definite measure of the relation between the monsoon rainfall and the area of these two crops, they indicate a very close dependence of the unirrigated cropped area on the monsoon rainfall.

The use of the correlation coefficient may be employed to carry the argument a further stage. In a particular instance the relation between the monsoon rainfall and the unirrigated wheat area is given by a value

$$r = + 0.8115$$

For the same area the relation between the monsoon rainfall and the total area is given by

$$r = + 0.4575$$

While for the irrigated wheat the relation is given by

$$r = + 0.2115$$

a figure which a further calculation of error, into which it is not possible to enter here, shows to be negligible.

The interpretation of these figures is clear : the introduction of irrigation removes the area of irrigated wheat from the sphere of dependence on the monsoon rainfall.

It is only necessary to quote one further set of figures to establish the point I wish to emphasize and to the establishment of which the entire previous remarks have been directed, namely, that the controlling factor in the agricultural development of the country is the supply of water for irrigation. During the last 10 years the average total area irrigated from all sources has been 108 lakhs of acres out of an average total of 347 lakhs of acres of cultivated land—a percentage of 31 only and a percentage which the introduction of the Sarda Canal will only raise to 34. Nor is this a true measure of the area unirrigated for, in years of drought, it is the unirrigated area that is reduced and the area of land uncultivated from this cause in such years is sufficient appreciably to swell the normal total cultivated area. The key to the problem of agricultural development is thus to be found in the water supply.

I have throughout the above argument limited my illustration to examples involving area for the reason that the statistics for areas of the crops of the province are very accurate. Yield, however, is, to the holder of a definite amount of land at any rate, an even more important matter. Practical considerations make the determination of the relation between rainfall and yield a matter of some difficulty, for no accurate statistics of yield are available. The whole question is now under investigation. It would seem probable, however, that the conclusions arrived at in the case of area would hold with even greater force in the case of yield. The area sown to a particular crop is determined not only by the available land in a condition to be sown to that crop but by the total of the individual opinions of the different cultivators as to what crop will pay them best. Once the crop is sown and accepting a standard normal cultivation, the yield would appear to be determined almost entirely by climate. In the case of rains crops the climatic factor is clearly

the monsoon but in the case of the *rabi* this is not so obviously so. The winter rainfall will be a potential and almost certainly the most important factor but the extent of the dependence has still to be worked out.

Sufficient has been said to show the vital importance of the rainfall on the agriculture of the province, an influence which is not controllable by man. This fact has only one practical interpretation, namely, that if agriculture is to be rendered less precarious and consequently to become the assured proposition which will attract the capital so urgently required, the prime need is for a controllable water supply. The possibilities of developing such a supply are, therefore, worthy of close consideration.

The approximate figures of the irrigated area are here given—

Canals (Government and Private)	..	22.5	lakhs	acres
Reservoirs	0.6
Wells	52.6
Other sources	22.5

and we may briefly consider these in turn.

The canals are mainly supplied from the rivers arising in the hills. Of these the Jumna and Ganges canals already use the total supply of these rivers while the Sarada Canal is now under construction. In the south the streams arising in Central India irrigate an area of about 1.75 lakhs of acres.

The perennial rivers have thus been, or will shortly be, put to their fullest use and any large extension in this direction cannot be looked for. A further feature of the older canals requires to be noticed, it is that these are still run on a protective basis. By this is meant that the available water is supplied to the commanded area with the important result that, owing to the prescriptive rights established thereby, in times of short supply restriction occurs in the direction of fewer runnings throughout the commanded area and not in the direction of a reduction of the area to which a full supply is given. Necessary though this policy is, it has its disadvantages for, though it may mean the largest benefit to the community as a whole, it also means reduced yield to the individual who, therefore, suffers under a sense of grievance. The important point that I desire to

emphasize here, however, is that, even in the canal tracts, there is ample scope for an additional supply.

Reservoirs are of little importance except in the tracts south of the Jumna. They are confined to the southern districts where the undulating country makes the construction of *bundhs* (embankments) a practical proposition. They may be provided with an outlet and irrigate land lower down the valley or the water may be let away and the bed ploughed and sown.

Wells are and will, even after the construction of the Sarda Canal, remain the major source of a controlled water supply throughout the Gangetic alluvium and the Doab. South of the Jumna the ground water supply is precarious.

Other sources of supply include *jheels* (natural lakes or swamps) and tanks. These are chiefly used in the east of the province in which some 14·7 lakhs of the 22·5 lakhs of acres so irrigated occur. This is not an expanding supply; rather is it a diminishing one. Pressure of population is leading to the reclamation, by means of drainage schemes, of the *jheels* for cultivation—a development which is likely to be further stimulated by the progressive importance attached to questions of health.

The point that stands out as the result of this brief survey is that there is relatively little more development possible in the direction of irrigation from the superficial water supply of the province. There remains only the subterranean supply from which further supplies can be drawn. This, fortunately for the province, is unlimited throughout the major portion of the alluvial area lying between the Hills and the Jumna-Ganges line and the question of agricultural development, being as it is in the first instance a question of an assured water supply, is, therefore, primarily one of the development of wells.

To explain my next point I will turn from the province as a whole to tracts without irrigation by any canal and in which, therefore, all irrigation is from wells or other sources, the essential feature of which is that the water has to be lifted. The following figures are for the year 1921-22—a year of good rainfall in which *jheels* and tanks were full and the water level relatively high, a year therefore

in which the labour of irrigation was at a minimum. They illustrate the point.

	Nett total cropped area	Well irrigated	Irrigated from other sources	Per cent. irrigated
Budaun	934,463	47,259	20,178	7.2
Fyzabad	706,413	222,040	140,748	52.7
Gorakhpur	2,109,490	449,801	374,861	39.1
Jaunpur	642,245	316,961	35,553	54.9
All non-canal tracts ..	17,425,855	5,523,373		31.7

	<i>Rabi</i> , cropped area	<i>Rabi</i> , irrigated all sources	Per cent. original
Budaun	563,084	54,105	9.6
Fyzabad	449,678	331,919	73.8
Gorakhpur	1,258,420	740,207	58.8
Jaunpur	366,600	317,383	86.6
All non-canal tracts ..	10,394,186	4,990,309	48.0

The percentage in Jaunpur is high but it is exceptional and the average indicates that less than a third of the total, and one half of the *rabi*, area is irrigated. While, therefore, considerable diversity of practice exists, the percentage of area irrigated from other sources than canals is low and this is the case even for the *rabi* when, it would be reasonable to suppose, efforts to use all available means of supply would be made. There can be little doubt that the argument holds for all tracts and it is for simplicity's sake only that I have confined myself to the non-canal tracts. There is clearly some influence at work which limits the area irrigated by such means, and it is clearly essential that this influence should be identified if the problem of development is to be solved.

I think it may be accepted as unquestionable that the cultivator will irrigate to make up a deficiency of water if he can possibly do so. Accepting also the fact, which the relation that I have shown to hold between the crop and the rain must indicate, that water is the controlling influence in agriculture, it follows that the percentage of

irrigated land to unirrigated is a rough indication of the difficulty experienced in raising water. Thus the difference between Mirzapur with 7·8 per cent. only of its cultivated area irrigated by wells and "other sources" and Benares with 57·5 per cent. so irrigated is clearly due to the difficulty of well construction in the two districts. This will certainly hold for neighbouring tracts though the decrease in percentage irrigated area which accompanies the gradual passage to submontane conditions probably means a less dependence on water artificially supplied. This fact, in conjunction with the fact that, even in the tracts most favourable for irrigation, a large area is not irrigated, has only one interpretation—the cultivator has not the capacity to lift more water than he does. From wells, which supply more than half the irrigated area, from other sources which supply nearly another quarter and from canals too to a certain extent, water can only be obtained by lift—that is by labour or work. I know of no figures to show the ratio between water lifted by hand and by bullock power but undoubtedly this combined power is limited and insufficient. Agricultural development, in the Jumna Gangetic alluvium at any rate, works back, therefore, primarily to a question of the provision of power to lift water; the water is there but the power to make it effective is not.

The three types of power are hand, bullock and mechanical. The facts given speak for themselves, hand and bullock power are not sufficient or there would now be little land left unirrigated. The question at once arises whether it is not possible to increase these sources of power. I think both forms of power can be dealt with in one for they have this in common that they both arise from live beings which require the use of the produce of the land for their sustenance. At the present time a condition of stability is reached which any variation arising therefrom shows to be a vicious circle—it is impossible to develop larger food supplies without more power and more power cannot be developed without larger food supplies. It is possible that the fact that there is an exportable surplus and that other than food, and fodder, crops are grown may be considered to refute this argument but I think not. Man does not live by bread alone and his other needs can

only be provided by exchange for wealth produced over and above that which will directly satisfy his own essential needs. I, at any rate, feel myself compelled to the conclusion that we must turn to the third source of power if we are to break the circle, but it is a conclusion which carries with it certain inevitable corollaries which we must now consider.

Directly we pass to mechanical power the whole economy of the affected area is changed and the chief feature of the change is a passage to a strictly cash basis. Man power is to a small extent, only when the labour is hired, on a cash basis. For bullock power a capital provision in cash is necessary but the "running charges," if I may so term them, are not in practice a cash charge unless the bullocks are employed on hire. In the case of mechanical power both capital and running charges are strictly interpreted in cash. Capital, therefore, is essential if mechanical power is to be employed.

Another, and, I think, equally definite, feature of mechanical power is that it is more expensive. This, I am inclined to think, would hold good even against the cash equivalent of the personal service of man and bullock, were such an equivalent practically obtainable, which it is not. Certainly it is more expensive when cash is weighed against personal service. For mechanical power to be effective, therefore, two conditions are essential; the water so raised must not be wasted which, practically interpreted, means the provision of impervious distribution channels, and it must be used to the fullest advantage, the practical interpretation of which is that the most valuable crops must be grown. A corollary of the former, the necessity for *pukka* channels, seems to indicate the desirability of reducing within limits the size of the plant and of increasing the number.

We have, therefore, three conditions which seem to me essential if pumping by mechanical power is to develop: the provision of capital, the establishment of small units and the growth of valuable crops; and the development of agriculture will depend on the satisfaction of these three, of which the first is fundamental; it may not be possible to develop power pumping as a successful financial

venture without the last two but it will be impossible to develop it at all without the first.

The development of a commercial transaction, as must be any development on a strictly cash basis, which I have shown this to be, is dependent on the probable interest to be derived from the invested capital. What then are the sources of such capital; and whence can capital be attracted? I can conceive of the following.

Government. But clearly Government cannot intervene here; the overhead charges for an inspecting staff of such widely scattered installations places this out of the question although Government have the great advantage of an organization by which charges could be realized.

Private commercial agency. Still less is this possible. Not only are the overhead charges for inspection and maintenance the same as for Government but the only method open for realizing overdue payments is through the courts.

The cultivator himself. Here the individual cultivator has neither the initiative to use nor the capital to invest, usually also he has no sufficient area at his command. It is true that capital might be available on a co-operative basis but a pumping plant is localized and co-operation between those owning a compact area would be required. Co-operation has not yet taken root to this extent. It is doubtful if co-operation would effect this even in a country where co-operative development has been considerable and where the condition of land tenure—I refer to small and divided holdings—is similar to that of this country, as is the case in Belgium. The further essential, the growth of valuable crops, appears to me to rule out this possibility. Co-operation must in that case extend not only to the erection of the plant and the distribution of the water but to the handling of the crop. I am afraid we must seek the initiative elsewhere.

The zemindar. Here, if anywhere, is to be found the agency by, and through, which the development can take place. I have been unable to trace any figures showing what percentage of the land is held as zemindari in sufficiently large blocks but it is undoubtedly large. The zemindar has the capital, or the security:

necessary to raise it. He has also sufficient area. He can, and he will, effect the development and he can make a handsome return on his capital. Let me describe the essential features of the development from the zemindars' point of view.

We are considering a commercial proposition which involves, as I have stated, an attractive return on the capital invested, that is, on the capital sunk in the plant and distributing channels. Suppose now, he instals such a plant capable of protecting some 300 acres. He will retain an area, say of 100 acres, in his own possession and on this he grows the valuable crop, potatoes, tobacco or cane, the latter I take for example, which is to pay the bulk of return on his capital. On this he will at the start grow some 10 acres of cane and he erects a *bel* (indigenous installation) for the conversion of juice into *gur* or *rab* (crude sugar). The main differences between mechanical power and bullock power are that the use of the former may be continuous while the latter must be intermittent and that the running charges are, in the former case, proportional to the use and continuous in the latter. Hence the longer the power plant is in use the greater will be the return. He will, therefore, find use for his plant when it is not required for pumping; he will use it to crush his cane and he can, with additional machinery, use it for threshing his wheat or even for extracting oil. The power plant must, therefore, be selected with discretion and be adapted to undertake these additional duties efficiently. Outside the area under his direct control he will be in a position to supply water and will reap the advantage of the higher rents which a guaranteed water supply commands. These are the results directly arising out of a power plant and there is little doubt that the financial return will be sufficient to make the proposition an attractive one provided the plant be well selected and provided the valuable crop be grown. Where such installations have failed it is usually directly traceable to the neglect of one or other of these provisos; the plant cannot pay if it is used merely to provide water on payment for the growth of the standard crops of the province. The Shahjahanpur Farm, on a capital of Rs. 85,000, last season made a profit of Rs. 6,700. When it is remembered that this

is a research farm which carries abnormal overhead charges and on which not immediately productive expenditure is incurred, and when it is remembered that it cannot use its power equipment to the full capacity because it cannot undertake subsidiary, and purely commercial, work as oil-crushing, the possibilities of the development proposed stand out even when judged merely as a financial proposition and when the gain to the community of an increased average production is ignored.

This, however, is the crudely commercial aspect of the question ; the potentialities do not end here. The home farm will be in the nature of a demonstration farm and the progressive zemindar will proceed to erect a second *bel*, to supply which he will assist the tenants whose land is commanded by the irrigation system to grow cane for him ; he will finance them and organize the supply of manure required for the crop. It is here that the full potentialities of the system become apparent. The direct, as well as the indirect, effect of introducing cane of improved types such as can readily be grown on controlled water supply is again well illustrated on the Shahjahanpur Farm. The effect is not limited to the cane crop but wheat grown subsequently, and again I only take wheat as an illustration, has yielded an average of over 30 maunds per acre. The inducement, once he appreciates the fact, should stimulate the tenant to seek to grow cane on terms which will yield a handsome profit both to himself and the zemindar while developing at the same time the material prosperity of the country, for the cultivator's profit will lie very largely in the subsequent crop.

We have here one of the most powerful potential influences for agricultural development. Improvements that have been made since the institution of the Agricultural Department have been many, but full benefit has not been derived from a large number of them because they are based on a low standard of cultivation due, in its turn, to a deficient water supply. I may illustrate my meaning by one practical example. The introduction of the Pusa wheats has doubtless been a source of considerable profit to the country but the full benefit has not been developed. With a standard of cultivation capable of giving 30 maunds of wheat to the acre the wheats

commonly grown would fail. Many of them would fail because their weak straw prevents that weight of grain being carried. The richest irrigated wheat tracts only average some 17 maunds grain per acre and, except near cities, the cane grown is of the Ukh variety which alone is capable of surviving on the existing available water supply. Increase that supply and make it assured and a vastly improved standard of cultivation is at once possible. It is here that the key to agricultural development is to be found.

I have dealt so far with the material aspect of the question but there is another and less material one. I have always regarded the economic organization of the rural tracts as deficient because it leaves to one important section of the rural community, the zemindar, a passive rôle. The distribution of functions is uneven and no organization possessing that feature can be sound. The development outlined remedies that defect. It weaves the zemindar more effectively into the rural organism of which he becomes an active member. A relation of co-partnership arises between the zemindar and the tenant to the great advantage of both. I visualize the ideal development as that which builds up a number of home farms, if not personally supervised by the zemindar himself, at least in the hands of an interested agent—interested in the sense that he is paid by results. The importance of this aspect cannot be overestimated. The “metayage” system of France is a development on these lines and its fundamental condition is commonly supposed to be the division of produce between landlord and tenant on a system similar to *batai*. That may be the essential characteristic but it is emphatically not the essence of its success. In Italy “metayage” is not popular just as *batai*, with all its derivatives, is not popular in this country. No, the measure of its success is determined by the extent to which the landlord takes a personal interest and the extent to which he recognizes the community of the interests of himself and tenant. This is the essence. A well-known taluqdar recently remarked to me that he found no interest in watching the bullocks go round on the threshing floor in the customary manner of centuries. That disability is here removed. In the home farm of sufficient size efficiently to employ up-to-date methods, in the

collateral development of sugar manufacture, oil-crushing and so on and in the organization of the sale of produce ; surely in all these there is enough to supply the needs of those most active of mind and body.

That is the ideal, and is it not an ideal worth striving for ? I myself think so. But I am not sufficient of a visionary to imagine that so drastic a change can be readily brought about ; to imagine that the seventy thousand odd installations necessary to irrigate the present unirrigated area will ever materialize. The practical difficulties in the way, such as the questions of land tenure, are too great. But I am sufficient of a visionary to believe that gradual development on these lines is possible and to an extent sufficient materially to alter the standard of agriculture of the province, and I incline to believe it to be the only evolutionary means.

TRACTOR CULTIVATION AT LYALLPUR, PUNJAB.

BY

H. R. STEWART, A.R.C.Sc.I., D.I.C., N.D.A.,
Professor of Agriculture, Punjab, Lyallpur ;

AND

D. P. JOHNSTON, A.R.C.Sc.I., N.D.A.,
Deputy Director of Agriculture, Punjab, Lyallpur.

INTRODUCTION.

THE question of cultivation of the land by mechanical means has been largely engaging the attention of agriculturists since the war. Many causes combined are responsible for this. In western countries where most investigation has been done on the subject, it was brought about primarily by the scarcity and high cost of labour. The high prices to which foodstuffs have gone during and since the war also prohibit the maintenance of stock on the same scale as was possible in earlier days.

Up to the present, no literature has been published on the subject of tractors in the Punjab. Indeed very little information is yet available regarding them for any part of India. Enquiries are constantly being made as to what is the best type of tractor to purchase for the Punjab, what is its daily outturn of work, what is the cost of cultivation by this method, etc., etc. It is with a view to answer some of these queries, and to give intending purchasers the benefit of our experience on tractors at Lyallpur up to the present time that this article is published.

TYPES OF TRACTORS.

There are on the market at the present time more than fifty makes of tractors to choose from, and these include at least seven recognized types. They may be classified as follows :—

- (1) The ordinary four-wheeled type, whose two rear wheels are driven, *e.g.*, the Austin.
- (2) The caterpillar type, which runs not on wheels, but on two endless chain tracks, *e.g.*, the Cletrac.
- (3) The three-wheeled type in which all three wheels are driven, two wheels being in front and one behind. It is so arranged that when in motion the weight is equally distributed on all the wheels, *e.g.*, the Glasgow.
- (4) The three-wheeled type, with one wheel in front and two behind. In some of these all three wheels are dissimilar in size, and the leading wheel and one of the rear wheels run in the same furrow. Here only the two rear wheels are driven, *e.g.*, the Whiting-Bull.
- (5) The three-wheeled type, with two wheels in front and an immense driving wheel, 54 inches wide, in rear, *e.g.*, the Gray.
- (6) The self-contained motor plough type, whose engine and gearing are balanced around a driving axle carried in two driving wheels, *e.g.*, the Crawley. This type can be converted from a plough to work cultivators, harvesting machinery, etc., by removing the rear portion of the frame and substituting for it a footplate arrangement, thereby converting it into a tractor.
- (7) The self-contained motor plough type possessing no wheels but driven on an endless track, *e.g.*, the Martin Track. This type is also adaptable to other work and can be converted into a tractor in much the same way as the last mentioned type.

CHOICE OF TYPE.

Of the seven types enumerated above, the last two are really self-contained ploughs and not tractors though they can be

converted into such. So far as is known, no such implements have yet found their way to India. Certain it is that there are none in the Punjab. No further notice will therefore be taken of them in the present article. Types 3, 4 and 5 are also very uncommon, and at present competition lies mainly between the ordinary four-wheeled type and the caterpillar type. It is therefore proposed to confine our remarks to these two main types only.

In selecting a suitable type of tractor it should at the outset be noted that both kinds will not suit all work equally well. Each has its advantages and disadvantages, and the type which will meet the needs of any individual purchaser must be determined to some extent by the various operations for which he intends to use it.

The four-wheeled type may be said to be general purpose tractors, and can perform, amongst others, the following operations:—

- (a) Ploughing, with which most people associate tractors generally.
- (b) Cultivation with disc-harrows, cultivators, spring-tooth harrows, rollers, seed-drills, etc.
- (c) Harvesting operations, with reapers, binders, etc.
- (d) Stationary work, *e.g.*, driving pumps, fodder cutters, threshing mills, ginning machines, cane crushers, etc.
- (e) Haulage work, transporting farm produce, etc.

For all work on the land the driving wheels of these tractors must be fitted with cross-bars or spuds to give them grip and prevent slipping. When the surface travelled on is firm and the spuds can obtain a good hold the percentage of slip is very low, but where the land is loose and sandy in nature a fair proportion of power is lost in slipping. Tractors of this type are, therefore, not specially well suited for after-cultivation work. For haulage work or travelling at other times on *pakka* roads care must always be taken to remove the spuds. Some tractors are supplied with

an outer rim which fits on over the spuds. This saves much time and labour when travelling from one field to another. The caterpillar type may, if we exclude haulage on *pakka* roads, also be styled a general purpose tractor. As already stated, it possesses no land wheels but as it moves along lays down its own track which consists of two endless chains. As a pulling force on land it far surpasses the wheeled type. The uses to which it can be put include all those enumerated for the wheeled type, but its great merit lies in the fact that it can do as good and as much work on loose sandy soils as it can on those of stiffer types. The endless chain tracks eliminate all the losses connected with slipping. It is on this account by far the most suitable type for after-cultivation work. In addition, the weight of this class of tractor, being distributed over a much larger area, does not pack the soil over which it passes so much as the wheeled type. Experience at Lyallpur showed that, on many occasions where the wheeled tractor failed to pull cultivating implements over loose soil, the caterpillar did the same work with ease.

A point worth notice, especially in land irrigated by canals and wells as in a great part of the Punjab, is the space required for turning, or in other words the size of the headlands. Many of the wheeled types have been observed to require a very large turning area. All of them require a larger area than does the caterpillar tractor. Where fields must necessarily be small the matter of turning radius cannot be neglected. For work in such fields the caterpillar is a much more useful type than the wheeled. It is capable of being turned in its own length, and in actual practice here it is being turned with implement attached on a headland of four yards. It is for this reason suitable in places where the other type is not.

The question of the life of the track of a caterpillar is one on which there is at present very little information. It is evident to even the most casual observer that the wear and tear of the track must be more than that of four wheels, but whilst this is agreed by all there are no statistics available from actual use of these tractors in this country to show exactly what the life of the tracks

is expected to be. Though the general feeling is that their life will be comparatively short, there is at present no definite proof that this is so. As to the comparative amounts of fuel consumed in driving these two types when loaded there does not appear to be anything to choose between them.

It may be concluded then that for ploughing on hard firm lands the wheeled type is probably the better and in the long run may prove cheaper, since there are no expensive, and probably short lived, tracks to be maintained. If, however, the work is to be mainly done on light sandy soils, or after-cultivation, or in small areas, the caterpillar tractor is the better one to use.

For all kinds of stationary work both types are equally suited, but in this connection a point of practical importance arises. In some tractors, irrespective of which type they fall under, the driving pulley is set transversely in front of the machine. As in most cases the operator sits at the rear, the matter of exact alignment of the belt is one of extreme difficulty and even when got is not easily maintained. Some of the best tractors on the market to-day suffer from this fault. The pulley should be so placed that the driving belt works parallel to the long axis of the tractor. Between engine and pulley a clutch should be interposed, otherwise starting the engine with belt in position is a difficult operation. Many tractors have the driving pulley keyed directly on the crankshaft: this is a great mistake. Most tractors have sufficient horse power for driving all ordinary farm machines.

Having settled on the type of tractor, the purchaser should take note of the following points if the tractor is to work satisfactorily under Indian conditions. It should be fitted with—

- (a) Either a tube or honeycomb radiator of at least eight to ten gallons capacity.
- (b) A good fan for drawing a rapid current of air through the radiator.
- (c) A circulating pump for forcing the water rapidly through the radiator. The thermo-syphon system is much too slow for a hot climate and is useless for stationary work.

In many of the tractors now working in this country the water in the radiator is at boiling point all the time and this within a short time of starting the engine if the load is heavy. This must be detrimental to the life of the engine, and, in addition, causes a waste of power which means a higher consumption of fuel per acre. If an ordinary motor car were to heat up to anything like the temperature reached by most tractors, the driver would stop and allow it to cool. Because a tractor is not so attractive looking a piece of machinery as a motor car, the idea seems prevalent that overheating is of no importance. This is the reverse of the actual truth. Unlike a motor car, the engine of a tractor is going full speed all the time and so requires even more attention than that of a car. If, therefore, the tractor is to give satisfaction the question of overheating must be looked to.

The carburettor, for preference, should be automatic or fitted with an adjustable jet. This is necessary for economic use with the various grades of kerosene oil.

On account of the extremes of temperature in the Punjab pre-heated air with hot-spot (as in the Austin) is considered essential for engines intended to run on kerosene oil. This will economize fuel and result in cleaner running of the engine with less trouble from carbonised sparking plugs.

Under Indian conditions a tractor is working most of the time in an atmosphere saturated with dust and grit. If this grit is allowed to enter the cylinders with the air it gets into the valve seatings causing them to leak and also causes wear to the pistons and cylinders much the same as would emery. To overcome this a water air clarifier should be fitted. A case recently came to the notice of the writers where pistons had to be replaced after three months' use due to excessive wear caused by improper filtration of air.

Great difficulty is often experienced in starting the engine. This could be surmounted if impulse starters were fitted. There would also be less danger of backfiring and damage to the operator.

Correct lubrication is a vital matter in maintaining the tractor in the best working condition and in keeping down the account for replacement of parts. It should be automatic for all the main working parts and should be rendered as foolproof as possible. Forced lubrication by means of a pump is best and a pressure gauge should be fitted whereby the operator can see at any time whether the machinery is being properly oiled. Grease caps should be provided on all other moveable parts and should be of sufficient capacity to maintain the bearings efficiently lubricated for one day. Experience shows that oil holes quickly get filled with grit and the average operator in this country will not take the trouble to clean them out.

LIFE OF A TRACTOR.

Most authorities limit the span of life of a tractor to five years, but at present there is no evidence that it will not be more. In most makes of tractor the engine runs at a speed of about 1,000 revolutions per minute. If this speed could be halved, while still maintaining, say, 25 B.H.P., it would probably be possible to prolong the life of the engine by at least 50 per cent. as it is always this part which wears out first. Lowering the speed of the engine might mean an increase in the weight of the tractor, but in a dry climate like India this would make little difference. It might also increase the price but this would be more than compensated if the tractor were to last, say, seven-and-a-half years instead of five. The original capital outlay is not so important as prolonging its life and keeping down cost of replacements by fitting out the tractor to suit the climate in which it is intended to work.

The question of spare parts is at present one of the most serious drawbacks to the extension of work by tractors in India. There are many makes on the market here but only a few of the agents can give a written guarantee that all possible renewals are stocked in the country. Until this is possible no one can with any confidence recommend the farmer to discard the bullock for the motor driven plough. As an instance, a case may be cited where

in the Punjab some radiator tubes of a well-known make of tractor became accidentally damaged. No replacements could be had in India and six months elapsed before they arrived from England. During all this time the tractor was useless, and had the owners been solely dependent on it for cultivation the result would have been nothing short of disastrous. The position with regard to spare parts in India is improving but there is still much to be done before it is even satisfactory. At present it cannot be said to be so. It is only to be expected that, with such a high speed machine as a tractor, breakages will occur. The impossibility of obtaining a full supply of spares puts the use of certain tractors beyond consideration. It is not going too far to say that before deciding on purchasing any particular tractor the buyer should obtain a written certificate that all spare parts of this machine can be had in India.

The next serious handicap to the use of tractors in India is the lack of properly trained mechanics to look after them. When a firm sells a tractor, a man is usually sent for a few days to instruct the purchaser in its use. With only the help given during these few days no man without previous experience is capable of taking proper care of the tractor thereafter. None but a man who thoroughly understands all about motor engines and their care is of any use if the tractor is to be maintained in proper running order. It is thus hopeless for anyone to attempt to run a tractor until he puts it in charge of a properly trained mechanic. These are difficult to obtain in the East. Untrained men do not understand the use of mechanical tools and one invariably finds them tackling the sparking plugs with hammer and chisel. A half-trained mechanic is an unsound investment where tractors are concerned, for through ignorance or neglect he can cause the breakage or wear of some part which will cost much to replace. For the economic use of fuel, as well as to keep down the replacements bill, a sound mechanic is indispensable.

If motor tractors are to be a success here, it is felt that the selling firms should have a staff of highly trained mechanics, one of whom it would be possible for the purchaser to engage for a

period of, say, three to six months during which time he would train another mechanic in all that he could reasonably be expected to know. Efficient mistries are not to be picked up at every corner in India, and if every purchaser could have his own man trained by some such scheme as that suggested, it is believed that the popularity of tractors would be greatly increased.

Another difficulty with which the purchaser of a tractor is met is that the instructions sent with the machine are not sufficient. Some firms issue with their tractors a manual of instructions, others either issue none or supply a handbook with so little information that it is of little use. What is wanted with every machine coming into India is a manual after the style of that provided with the Ford motor car.

It is difficult to give an exact figure as to the size of an economic holding for a tractor. This will depend on the system of cultivation, the number of operations it is proposed to perform with the tractor, etc. Experience has shown here that five acres per day is the maximum average that can be worked with a three-furrow plough while 12-15 acres can be disc-harrowed. Allowing for the tractor being out of commission from all causes for eight days in the month, it means that in a month 110 acres could be ploughed, while two months' preparation for *rabi* and two for *khurif* crops would allow for a total of 300 acres per annum. These figures depend largely on the system of cultivation and are here taken for 100 per cent. intensity.

The economic use of a tractor depends upon how many operations are to be done by it. The depreciation generally allowed is at the rate of 20 per cent. per annum, and it depreciates whether in constant use or part time idle. To be economical, therefore, it should be used for all kinds of general work, in addition to the cultivation of the ground. Many operations are carried out in the farmyard which could more economically and more speedily be done by tractor power. These include fodder cutting, cane crushing, threshing, etc. The owner of a tractor should therefore, if he is to get full value out of his purchase, provide himself with suitable machinery to be driven by it.

The following are the main points to attend to in the purchasing of a tractor :---

- (1) It should be suited to the kind of work for which it is to be used. This work will determine which type should be purchased.
- (2) It should be provided with a large radiator, a fan and a force pump for cooling.
- (3) It should have a proper kerosene oil vaporiser.
- (4) Should have a water air filter.
- (5) An impulse starter is a great advantage.
- (6) Lubrication should be automatic for all the main working parts.
- (7) All possible working parts should be encased and not exposed to wear and tear from dust and grit.
- (8) There should be a complete supply of spare parts in India.
- (9) The selling firm should be asked to supply a skilled mechanic for a period of from three to six months.
- (10) A complete manual of instructions is necessary with diagrams of all working parts and a complete spare list.
- (11) It should have two forward speeds of about $2\frac{1}{2}$ and 4 miles per hour respectively and one reverse speed.
- (12) The draw-bar should have a wide range of lateral adjustment to enable tractor to run on unploughed land.
- (13) Belt pulley should be parallel to long axis of tractor with sufficient clearance for at least an 18" diameter and 6" wide pulley capable of working belt either forward or backward.
- (14) A clutch should be interposed between engine and belt pulley to facilitate starting.
- (15) Engine should be governor controlled.

COST OF CULTIVATION.

The following are the costs of the various operations at Lyallpur as shown by the work done up to the present. The soil is light alluvial.

(a) *Ploughing.* Caterpillar type working with a three-furrow, self-lift plough.

Average depth ploughed	6	inches
„ width of each furrow	12	inches
„ work done	0.82	acre per hour
„ area ploughed	5.0	acres per day
Fuel used	2.2	gal. per acre
Lubricating oil	0.2	gal. per acre

Cost per acre.

						Rs.	A.	P.
Labour	0	10	0
Fuel	2	15	0
Lubricating oil and grease	1	0	0
Depreciation and interest on capital	0	15	0
					TOTAL	5	8	0

(b) *Ploughing.* Caterpillar type working with a two-furrow, self-lift plough.

Average depth ploughed	6	inches
„ width of each furrow	12	inches
„ work done	0.53	acre per hour
„ area ploughed	3.3	acres per day
Fuel used	2.9	gal. per acre
Lubricating oil	0.36	gal. per acre

Cost per acre.

						Rs.	A.	P.
Labour	1	0	0
Fuel	3	8	0
Lubricating oil and grease	1	14	0
Depreciation and interest on capital	1	7	0
					TOTAL	7	13	0

(c) *Disc-harrowing,* with caterpillar type.

Average depth	4	inches
„ width	9	feet
„ work done	2.6	acres per hour
„ „ „ per day	12	acres
Fuel used	0.96	gal. per acre
Lubricating oil	0.1	gal. per acre

				<i>Cost per acre.</i>		
				Rs.	A.	P.
Labour	0	4 0
Fuel	1	1 0
Lubricating oil and grease			0	3 0
Depreciation and interest on capital			0	6 0
TOTAL				..	1	14 0

Cultivation is also being done with a cultivator which covers a width of $7\frac{1}{2}$ feet each time, and with four spring tooth harrows fastened rigidly together. These take in a width of 11 feet. Figures are not yet available to show the costs of these operations.

The method adopted for arriving at the depreciation and interest on capital requires explanation.

Depreciation @ 20 per cent.	Rs. 1,040 per annum
Interest on capital @ 5 per cent.	" 260 " "
TOTAL			..
Average daily depreciation	Rs. 1,300
			.. 3-9-6

Allowing for tractor being out of commission from all causes 25 per cent. of the time, the average depreciation per day worked is therefore Rs. 4-12-0. The average day's work with a three-furrow plough being 5 acres, this amounts to As. 15 per acre. With a two-furrow plough it is, on the basis of 3.3 acres per day, Rs. 1-7-0 per acre, and with a disc-harrow, at 12 acres per day, As. 6 per acre.

(d) *Ploughing* with wheeled type, using three-furrow, self-lift plough.

Average depth ploughed	5 $\frac{1}{4}$ inches
„ width of each furrow	12 inches
„ work done	0.79 acre per hour
Fuel used	2.45 gal. per acre
Lubricating oil	0.15 gal. per acre

				<i>Cost per acre.</i>		
				Rs.	A.	P.
Labour	0	12 0
Fuel	2	12 0
Lubricants and grease			0	6 0
Depreciation and interest on capital			1	4 0
TOTAL				..	5	2 0

Depreciation and interest on capital is arrived at in a way similar to that done with the caterpillar type and in this case is as follows :—

Depreciation @ 20 per cent.	Rs. 1,370 per annum
Interest @ 5 per cent.	„ 342 „ „
		TOTAL ..	Rs. 1,712

Average daily depreciation and interest, Rs. 4-11-0. Depreciation per day worked, allowing for tractor being 25 per cent. of time out of commission, Rs. 6-4-0 or R. 1-4-0 per acre.

The costs do not include anything under the heading “replacements and spare parts,” as up to the present there is no information on which to base such an allowance. The amount shown for fuel in each case includes both petrol and kerosene. When starting the tractors it is always necessary to use petrol for a short time till the engine becomes heated, after which kerosene is used.

It was found that the wheeled type of tractor used could not pull the three-furrow in the class of soil under experiment if the depth exceeded $5\frac{1}{2}$ ". When it was desired to plough to a greater depth it was necessary either to use a two-furrow plough with it or use the three-furrow with the caterpillar type. Finally, mainly owing to slipping the wheeled type was unable to pull the disc-harrow, during after-cultivation, at the depth which was required. All this work has therefore had to be done with the caterpillar.

TRACTOR TILLAGE IMPLEMENTS.

(A) *Ploughs.* There are two types of ploughs in use with tractors :—

1. The mould-board.
2. The disc.

The former is the older and more common and is simply an enlarged form of the English share and Indian Rajah ploughs. Instead, however, of having but a single share, two, three or four are fitted together by means of a framework mounted on wheels and pulled as a unit. The number of shares being thus so variable,

the prospective buyer very naturally enquires how many his plough should have. The number depends primarily on the draw-bar B.H.P. of the tractor, which in most cases is 8 to 12 and is quite sufficient for a three-furrow plough on most Punjab soils. Experience has so far shown at Lyallpur that it is waste of time and power to use either the caterpillar or the wheeled type with a two-furrow plough. Both tractors are able here to pull a three-furrow as quickly as a two-furrow plough. Where, however, it was desired to plough more than $5\frac{1}{2}$ " deep at Lyallpur it was found that the wheeled type could only pull a two-furrow plough.

With regard to the choice between mould-board and disc ploughs, the former is better suited to varying conditions of soil and was found at Lyallpur to disturb the level of the land much less than the latter. This question of level is one of great importance on irrigated lands. Experience here makes us therefore favour the mould-board rather than the disc.

There are many makes of mould-board ploughs on the market with little to choose between them. Some have distinct advantages over others and those with the following points should be chosen for preference :—

- (a) The third share in the case of a three-furrow plough should be removable, so that in the case of stiff land or deep ploughing, where the tractor cannot pull three furrows, the implement may be convertible into a two-furrow plough. Many makes provide for this.
- (b) The tips of the shares should be adjustable, *i.e.*, it should be possible to increase or decrease the angle of dip at will. It is invariably found at Lyallpur that after a short time in work the point wears wedge-shaped from below, tending to make the plough run shallow especially in hard soils. In those ploughs whose tips are not adjustable new tips or resharping of the old ones will often be required.
- (c) Adjustments for altering the width of furrows, as well as the depth, should be provided.

- (d) The plough should be automatically self-lift. Some of the ploughs at present on the market require a man to sit on them, steer them, and raise and lower them at the headlands. This is quite unnecessary and adds to the labour bill. In some of the more improved ploughs the control is done by the tractor operator simply by pulling a lever or a rope which passes forward to his position on the tractor. This is all that is required, and on the Lyallpur farm this type of plough has given great satisfaction.

In the disc plough instead of shares we have got two, three or four saucer-shaped discs about 24" in diameter. These are set at an angle of 120° to the line of draught, the concave side facing forward. On being drawn through the soil the discs revolve cutting out a furrow in much the same manner as a share, but unlike the furrow cut by a share the disc-cut furrow is broken up and set upright rather than inverted. It disturbs the level of the land more than the mould-board plough and on this account is not so useful on artificially irrigated lands. The ground from which the furrow has been cut is in shape the segment of the arc of a circle. Consequently where successive furrows adjoin, a ridge is left and the ground is not all ploughed to an even depth. For breaking up rough land containing sugarcane stumps the disc plough was found very useful. On hard soils it is necessary to load the plough with additional weights to keep it in the ground.

A plough fitted with a self-lifting apparatus is very strongly recommended, even though manual labour may be plentiful and cheap. It is a great time-saver as the tractor need never stop at entering or emerging from the furrow. The operation of lowering or raising the shares simply consists in operating a lever from the tractor, whose driver works both tractor and plough. In non-self-lift ploughs three operations are usually necessary, *viz.*, two levers to be manipulated for raising and lowering the shares and one lever for steering. This is too much for any one man to do sufficiently quickly and is in addition a work requiring a fair strength. Consequently the tractor must come to a stop till

the necessary operations are performed. In a day's work all these halts amount to a considerable loss of time.

Many ploughs are fitted with steel rope hitches. With these it is almost impossible to guide the plough into the furrow or to control it on the headlands. The plough is inclined to float around the headlands, crashing into the rear of the tractor should the latter come suddenly to a halt. Triangular draw-bar hitches providing for lateral adjustments are best.

(B) *Cultivators*. This implement has from ten to twenty tines usually arranged in two rows. The cultivator in use at Lyallpur has eleven tines, five in front and six in rear, and covers a width of seven-and-a-half feet. The depth is adjustable.

This is considered quite large enough for any ordinary tractor. The work done somewhat resembles in quality that of a *desi hal*. It is an economical implement for stirring up soils on fallow lands. On certain *barani* (rain-fed) areas with sandy soil where nothing but grams can be grown, the cultivator has been doing good work and has replaced ploughing.

(C) *Disc-harrows*. These implements are of two types, some having only one row of discs, some having two rows. The latter is the tandem type and is much more efficient than the former. Each row of discs is broken in the middle and the halves hinged together. The inclination of the two halves to each other is thus adjustable. For good work this angle must be fairly small. In a one-rowed implement this is inclined to disturb the level of the ground a good deal and the second row is necessary, especially on irrigated lands, to counteract the disturbing influence of the first. In addition, it does more thorough work. These implements have a provision for carrying weights if they do not penetrate sufficiently into the ground when unloaded. The tandem disc-harrow is the most efficient pulverising implement so far tried at Lyallpur.

(D) *Spring tooth harrows*. An effort has been made to utilize the bullock-drawn spring tooth harrows for tractor cultivation by rigidly fixing together four of these implements. The experiment was a decided success. The power required to draw them was small, and a width of eleven feet was cultivated each time. A large

sohaga (wooden leveller) was also fitted on in the rear and in one operation the ground was ready for sowing.

Much investigation lies ahead in the matter of suitable tillage implements for this country. It is thought that probably heavy western implements of the types now being imported are not essential for the soils of the Punjab and that just as good results might be obtained with implements lighter in nature and possibly less thorough in their work. The zemindar has for centuries been getting abundant harvests whilst doing little more than scratching the surface of the ground with his *desi hal*. The question therefore remains to be solved, whether a type of implement doing lighter work than the heavy tractor plough of to-day might not be evolved, reducing the cost of cultivation whilst in no way decreasing the present time outturns.

BACTERIAL INFECTION OF COTTON BOLLS.

BY

EDWARD BALLARD, B.A., F.E.S.,
Government Entomologist, Madras ;

AND

DOROTHY NORRIS, M.Sc., A.I.C.,
Government Agricultural Bacteriologist, Madras.

THE question of insect transmission of plant diseases has been receiving ever increasing attention during the last twenty years, and there is a rapidly growing collection of literature on the subject. The bulk of the work has been done in the last ten years, and the connection between insects and bacterial and fungoid diseases of plants and crops has been established in a large number of cases.

In the majority of these cases the insect appears merely to provide a method of entrance for the bacteria or fungi rather than actually to inoculate them in the sense that malarial parasites are inoculated into man. That is to say, there is no definite biological relation between the insect and the parasite.

On the other hand, although an insect may, by boring into a plant, or by piercing the epidermis for the purpose of feeding on the plant juices, provide a means of entrance for the bacterium or fungus, it may also, by being itself contaminated with it, actually introduce the parasite by its method of feeding. In the same way it might be possible for a Capsid bug contaminated with some pathogenic organism to introduce it into a plant by the act of ovipositing.

It is not now necessary to enumerate all the cases where plant diseases are caused by bacteria introduced by insects but an excellent review of the position up to 1920 is given by F. V. Rand and D. Pierce in *Phytopathology*, Vol. X, No. 4, 1920.

Up to the present no work of this kind has been done in this country, and this note is simply a statement of what has been attempted in this direction in South India and what is to be done in the future.

During the pink boll-worm investigations of 1919-1920,¹ it was noticed that a certain proportion of small immature Cambodia cotton (*Gossypium hirsutum*) bolls, mostly of a maximum diameter of 1.5 cm., were shed from the plants and that these all showed the same symptoms, a discoloration of the boll and of the contained developing seeds, often accompanied by a discoloration of the lint and a slimy and rotten appearance.

No fungus being found which could be responsible for this, it was thought that bacteria were probably the causative factor. On the appointment of a Bacteriologist in 1921, the question was taken up again together with an attempt to solve the problem of how the bacteria effected their entrance into the boll.

The developing seeds were always the first part of the boll to be attacked, and when a young boll was cut across, instead of their appearing translucent, they all showed a dark brown discoloration. In addition to the other symptoms described above, the exterior of the young bolls showed black shining spots which were proved on a section being taken through the spot to be due to some injury causing proliferation of the cells surrounding the injured part and the formation of cork. These punctures could in some cases be traced right through the boll wall.

A small Capsid had already been found in 1920 which was suspected of being the cause direct or indirect of boll fall. This Capsid which has since proved to be a new species was also found to be associated with or accompanied by another, also a new species, which has similar habits.²

¹ Ballard, E. Results of investigation of bionomics of *P. gossypiella*, Saund. in South India. *Proc. 4th Ent. Meeting*, 1921.

² Have been named *Ragnus morosus* n. sp. and *Ragnus flavomaculatus* n. sp. and sent for publication. Ballard, E. Pink Boll-worm in South India, 1919-20. *Mem. Dept. Agri. India, Ent. Series*, Vol. VII, No. 10.

Both suck leaves and young bolls and are present on the plants almost throughout the season, becoming however rare towards the end of June.

It was from one of these that the Bacteriologist grew the bacillus also found in the diseased bolls. This does not of course prove any direct connection between the insect and the disease, but is nevertheless suggestive. There are in addition other sucking insects commonly found on cotton, namely, Jassids, Aphis and Thrips.

Trials were made of growing bacteria from the viscera of the Capsid but proved negative. As, however, the technique employed left something to be desired, this experiment is to be repeated. Attempts were made to rear sterile nymphs and adults in order to carry on retransmission experiments; these also failed owing to contamination by moulds but a method has now been evolved which, it is hoped, will give good results and it should be possible to raise as many sterile nymphs as are desired. The fact that they feed readily on agar-boll extract medium promises to facilitate the operation of keeping them alive and sterile once they have hatched from sterilized eggs. Attempts to induce females of the species to lay eggs in the agar-boll extract medium were also not very successful, although one or two eggs were actually laid.

A point which may not be without significance is that, with the partial disappearance of these two Capsids from the field, the amount of boll shedding has decreased in a most marked manner. This may be pure coincidence; on the other hand, it may be of great importance, since one of the methods of the spreading of bacterial disease of plants is by wind and this time of the year (June-July) is the really windy season at Coimbatore.

The amount of rain too which has fallen throughout the cotton season is negligible which removes to a large extent another possible method of dissemination of the disease.

A list is given below of the chief sucking insects found on Cambodia cotton (*Gossypium hirsutum*), but so far as any case has been made out at all the two Capsids above mentioned would

appear to be the most likely agents for spreading and inoculating the disease and causing the consequent boll fall. But it is not claimed that the disease is dependent on insect agency for its power to infect the bolls, a point which we realize is by no means proved and much yet remains to be done.

The following is the list of insects found on cotton, which could be the means of infecting it with a bacterial disease.

- (1) *Ragmus morosus* n.sp. MS. Capsidæ.
- (2) *Ragmus flavomaculatus*, n.sp. MS. Capsidæ.
- (3) *Megacælum* sp. *incert.* Capsidæ.
- (4) *Megacælum bisratensis*, Dist. Capsidæ.
- (5) *Empoasca devastans*, Dist. Jassidæ.
- (6) *Aphis gossypii*, Glov. Aphidæ.
- (7) *Lecanium nigrum*.
- (8) *Pulvinaria maxima*.
- (9) "Thrips" (undetermined).

Of these, one and two are present throughout the season but get scarce towards the end of June and beginning of July. Three and four are present in small numbers but increase in June-July. Five was only in pest conditions in the first part of the season and has yet to be experimented with as a possible carrier of the disease.

There were two outbreaks of No. 6 in December-January and towards the end of March, but *Aphis* were present in patches here and there throughout the season. They would not be capable of making the wounds in the boll wall referred to above.

Nos. 7 and 8 were always present but are not likely to be disseminators of the disease. No. 9 was present at all times of the season.

II.

The following investigation was undertaken in order, if possible, to ascertain the cause of a considerable loss of immature cotton bolls.

Statistics have only been collected for a short time and only in one small area (about four acres) for Cambodia cotton (*Gossypium hirsutum*) but the following figures are somewhat suggestive.

Total number of bolls shed from 100 plants between March 5th and June 17th was 2,645. Of these, 900 were due to boll-worm attack, leaving a balance of 1,745 or 66 per cent. It may be stated at once that in the area dealt with no signs of angular leaf spot disease due to *B. malvacearum* were discovered although this has been shown to occur in other parts of the Presidency.

Up to the present time it would appear that bacterial cotton diseases have received a great deal of attention in the United States of America,¹ and a considerable amount of work has also been carried out in the West Indies.² Very little has been attempted in this country and no effort has been made to estimate the amount of damage and loss from this cause.

According to C. W. Edgerton³ (1912), there are three species of bacteria common to rotting bolls.

By far the most important in Louisiana is *B. malvacearum*, Smith, and this is a true parasite attacking uninjured bolls.

The other two develop in injured bolls or bolls already affected by some other organism. Edgerton states that the annual loss in Louisiana due to all kinds of boll rot amounts to a considerable sum. Lewton-Brain⁴ (1904) reported the presence in affected bolls of a rod-shaped bacillus but does not seem to have followed up the observation. His work is referred to by South in Dunstan's collection of reports. Nowell⁵ (1916) suggests insect agency for both a fungoid and a bacterial disease and, as a means of control of disease, proposed control of the plant feeding bugs. He states that in Barbados where the cotton stainer does not occur he found the "internal boll disease" associated with the green bug. Harland⁶

¹ Smith, E. F. *Introduction to Bacterial Diseases of Plants*, 1920.

² Dunstan, W. R. *Papers and Reports on Cotton Cultivation*, 1911, pp. 177 and 207.

³ Edgerton, C. W. Rots of the Cotton Boll. *Louisiana Agri. Dept. Bull.* 22-140; *U. S. A.* 12, 1889-1913.

⁴ Lewton-Brain. *West Ind. Bull.*, IV, pp. 263 and 345.

⁵ Nowell, W. *West Ind. Bull.*, XV, 1916.

⁶ Harland, S. C. Manurial experiments with Sea Island Cotton in St. Vincent with some notes on factors affecting the yield. *West. Ind. Bull.*, XVI, p. 169, 1917.

in 1917 puts forward the same view ; he classifies the most serious diseases of cotton in St. Vincent as follows :—

- (1) Internal boll disease.
- (2) External boll disease.
- (3) Soft rot or *Phytophthora* disease.

(1) *Internal boll disease.* He considers this to be due to the agency of the cotton stainer (*Dysdercus delaunyi*, Leth.), *Nezara viridula* and possibly *Edessa meditabunda*, Fabr.

The disease had not been worked out as he speaks of it assuming a fungoid or bacterial phase according to weather conditions, the latter predominating during wet weather.

(2) *External boll disease.* This he considers due to *B. malvacearum* and here again suggests that weather conditions play an important part in regulating its distribution and the amount of loss caused by it.

(3) *Soft rot.* This disease is also dependent on high humidity.

It is interesting to compare Harland's figures with those given at the beginning of the paper. From a number of bolls collected just as they were dropping he classifies the diseases as follows :—

	Per cent.
Affected by internal boll disease	.. 64
Affected by external boll disease	.. 21
Healthy bolls 14·8

He definitely states that "all bolls classified under internal boll disease had that disease and no other," so that *B. malvacearum* would not appear to be the principal cause of loss from disease in St. Vincent.

Nowell¹ continuing this work in 1917 gives a summary of much of the research in this direction and briefly describes two bacteria isolated from bolls which are not *B. malvacearum* and do not give rise to leaf spot. He considers that under ordinary conditions in the West Indies fungoid infections greatly predominate

¹ Nowell, W. Internal disease of cotton bolls in the West Indies. *West Ind. Bull.*, XVI, p. 203, 1917.

over those due to bacteria but that the proportion of the latter appears to increase during wet seasons.

There has not been time yet to observe any effect of seasonal variation on boll fall in South India as the experiments were only started during the cotton season just over. Hence it is hardly necessary to state that much of the work so far carried out is necessarily of a preliminary nature and the experimental details and results given in the present communication will all require checking and amplifying as soon as the cotton boll again becomes available.

A brief description of the disease as it affects young bolls has already been given and also the fact has been stated that no fungus appears to be responsible.

It is to be noted that in a district where cotton stainers predominated the bolls attacked by disease were much larger than those in the district actually under observation. This again lends support to the view that insect agency is necessary for the dissemination of the disease, as it is obvious by comparing the sizes of the two insects under discussion that the cotton stainer is capable of puncturing a larger boll than the Capsid. Therefore, given a source of infection, one would expect to find such a state as that described above.

The organism was isolated by plunging the diseased bolls into mercuric chloride solution 1 in 1,000 and then into sterile water. They were then cut open with a flamed knife and portions of the diseased tissue removed for examination.

The culture medium mainly used in the isolation of the organism presently to be described is made as follows :—

100 gm. moist interior of young (medium sized) cotton bolls is extracted in a steamer with 100 c.c. water. The resulting mash is filtered, brought to +15 Eyre's scale and 4 gm. agar-agar added, and the whole then sterilized in an autoclave at 115°C. for one hour. The resultant medium is used either in plates or as slopes and is a dark reddish brown in colour.

If liquid media is desired the extract is tubed without the addition of agar. Various insects associated with the cotton plant

feed freely on the solid medium prepared as above and several organisms isolated from the cotton plant give copious growths on it.

The organism most frequently met with during the course of this investigation gives a whitish inclined to buff, very moist, shiny growth on the above media. On Ridgeway's scale it corresponds most closely to light ochraceous salmon. It has a distinct pearly lustre and darkens in colour with age.

In this connexion it may be noted that a darkening of the cotton boll culture medium occurs in the region of growth of the above organism. This is not due merely to other conditions such as drying or oxidation, as may be seen by comparison with uninoculated tubes of medium of the same age. This fact may possibly have some connection with the staining of the lint in the diseased cotton bolls.

It is a stout rod-shaped bacillus, feebly motile, Gram + ve and non-acid fast. It stains readily with Ziehl's carbol fuchsin, aniline gentian violet and Loeffler's methylene blue. It was usually grown at a temperature of 25-27°C. which is ordinary room temperature here.

It curdles milk in five to seven days and grows well on ordinary medium such as glucose bouillon, glucose agar, steamed potato and lactose broth. It gives Voges and Proskaucr's reaction and acid and gas in litmus glucose and litmus lactose broth. Grown in liquid cotton boll medium it gives a small amount of gas after three or four days at 28°C.

Two small field experiments were attempted during the season, neither altogether satisfactory. In every case the bolls inoculated with the organism rotted and dropped and the organism was recovered, but the controls which consisted of tender bolls lightly pricked with a sterile platinum needle also mostly developed the disease. On both occasions small showers were experienced during the course of the experiment which would tend to vitiate it. Also supposing that the specific organism is a normal inhabitant of the cotton plant merely waiting for an injury in order to establish itself, it must be remembered that the injury inflicted by even

the finest platinum needle is large when compared with that given by a Capsid.

It remains therefore to re-isolate the organism during the next season, to examine its cultural characteristics more closely, to try by spraying experiments whether insect agency is a necessity or not and to endeavour to form some estimate of the amount of damage due to this cause.

SUMMARY.

1. The rotting and premature fall of tender cotton bolls appears to be largely due to a bacterial disease which is not *B. malvacearum*, Smith. Angular leaf spot has not been found in the district under observation.

2. No fungus has been found associated with the disease in its early stages.

3. Insects appear to play a prominent part in the dissemination of the disease by affording a ready means of entrance although whether they are absolutely necessary has not yet been proved. The two which may be implicated in the spread of the disease are *Ragmus morosus* n.sp. MS. Capsidæ and *Ragmus flavomaculatus* n.sp. MS. Capsidæ.

Points in favour of the view that they are required are :—

(a) The amount of boll shedding declined with the partial disappearance of the two Capsids from the field although this happened during a period of strong wind which has been shown to have a considerable influence on the dissemination of disease¹.

(b) In the district immediately under observation no cotton stainers were observed and the boll fall apparently due to disease consisted almost entirely of very small bolls, whereas in another district infected with stainers the diseased bolls were much larger which is what one might expect from a comparison of the size of

¹ Faulwetter, R. C. Dissemination of angular leaf spot of cotton. *Jour. Agri. Res.*, 1917, p. 457.

the cotton stainer with that of the two Capsids described.

4. The organism considered responsible grows readily on a variety of culture media and produces moist whitish translucent colonies on agar cotton boll extract medium.

5. If the damage effected appears to call for control measures, insecticides may prove sufficient and it may be necessary to discover whether other plants serve as hosts for the insects implicated in the spread of the disease.

SOME INSECTS NOTED AS PESTS OF FRUIT TREES IN SOUTH INDIA.*

BY

T. V. RAMAKRISHNA AYYAR, B.A., F.E.S., F.Z.S.,

Assistant Entomologist, Madras.

THE very interesting and suggestive pamphlet published by Sir Frederick Nicholson on "A plea for the encouragement of a fruit-growing industry in the Madras Presidency" should certainly make both landed proprietors and the Government bestow more serious attention to this aspect of agriculture in South India, *viz.*, fruit culture. There are, of course, a few well-known fruit-growing tracts in the different parts of the Presidency, such as Salem, Chittoor and Vizagapatam famous for their mangoes; Krishnagiri, Penukonda and Michaelpatti for their grapes; Erode, Malabar and Palnis for their bananas; Coorg, Shevaroyes, etc., for their oranges, etc.; but for a tropical tract like the Madras Presidency where the possibilities and potentialities for such an industry are enormous these are comparatively very few and insufficient, and in many cases the industry is carried on with very little system or organization. It cannot be denied that the industry as a whole is capable of considerable extension and improvement. Government have already made a start in this direction by opening small fruit farms on the Nilgiris to begin with. Now that such a beginning has been made by Government, and as it is not unlikely that landed proprietors too will start on the same lines, it is necessary that the subject of fruit culture should be closely and thoroughly studied in all its aspects so that all such attempts might progress successfully. In this paper an attempt is made to bring together and present in a very brief manner our present

* Paper read at the Ninth Indian Science Congress, Madras, 1922.

knowledge of the entomological aspect of fruit culture in South India.

In spite of the absence of any extensive fruit culture in South India approaching anything existing in the well-known fruit-growing countries like California, Australia or South Africa, it is a matter of common knowledge that, just as our field crops like paddy, sorghum, etc., are subject to the attacks of insects, fruit trees are also liable to the undesirable attentions of insects. It is believed, therefore, that to one who is anxious to carry on fruit-growing on a fairly extensive scale on scientific lines, a knowledge of the insect pests that have so far been found to do some appreciable amount of harm to our native fruit trees will be of some real use side by side with a knowledge of other aspects of fruit culture, such as soils, manures, irrigation, varieties, etc. The information brought together in this paper is necessarily and admittedly imperfect for obvious reasons; the writer, however, hopes that it might form a small beginning to start with in the direction of pomological entomology, and might be of some help to prospective fruit-growers.

Numerous insects of various habits have been noted on the common fruit trees grown in different parts of South India. Of these, some have been found to cause appreciable harm while others have so far behaved only as insects of minor importance. In this paper only those of the former category, about which we have some definite knowledge, are described, while those of minor importance and others, of which our knowledge is imperfect, have been either omitted or simply made mention of. We will consider the insect pests of our different fruit trees in the order more or less of their importance and value in South India.

Mango. Insect injury to the mango plant is chiefly caused by four or five kinds of pests, *viz.*, the mango hoppers, the stem-borers, fruit flies, leaf-eaters and scale insects. The mango hoppers (*Idiocerus* spp.) are very small active creatures appearing in swarms on the tender shoots and flower-heads of the mango plant during the cold weather. They suck up the nutrition from the

tender parts and often produce serious damage by causing the blossoms and buds to drop down, thereby preventing fruit formation. This is the "honey dew" disease as it is called in some of the important mango tracts, and is well known to gardeners all over India. The failure of the mango crop in certain years is often due to this pest. The stem-borers, of which the commonest one is that popularly known as the mango stem-borer (*Batocera rubus*), are stout fleshy larvæ of longicorn beetles which enter the stem and burrow through the interior, feeding on the internal tissue of the stem. The borer is often found to kill the branches of trees or even at times the whole tree. The presence of the pest on the tree is indicated by the heap of powdery wood dust and excrement that is seen on the ground below the affected branch, and also by a gallery-like structure of the same materials on the bark of the infested stem. Fruit flies (*Chaetodacus* spp.) of two or three kinds sometimes cause severe damage to mango fruits. The wriggling whitish maggots of these flies are found inside infested fruits; the latter appear more or less healthy outwardly in the initial stages of infestation, but when cut open will show numerous white maggots burrowing through the pulp and making the fruit unfit for consumption. What happens is that the adult flies thrust their eggs just under the soft skin of the ripening fruits and these eggs become the maggots which, after feeding on the pulp, drop to the soil and become flies after passing the pupal stage. A good percentage of some of the valuable varieties of mango suffers from this kind of injury in Bangalore, Chittoor and Salem in certain years. Of the leaf-eating pests of mango we might note the common nettle grub (*Parasa lepida*) of South India, an apple green slug-like spiny caterpillar very irritating to the touch. Young plants suffer more than grown up trees; in the former case the plants are often completely defoliated by hundreds of these slug-caterpillars. Weevils of different kinds often do appreciable damage to the foliage, the leaf-twisting species (*Apoderus tranquebaricus*) being the chief. The mango weevil (*Cryptorrhynchus mangiferæ*) though found in South India is not an important pest. Scale insects and mealy bugs (*Chionaspis*, *Pulvinaria*, *Lecanium*, *Pseudococcus*, etc.)

are also occasionally found doing damage to the mango plant in different places.

Citrus. The different varieties of citrus, such as sour and sweet limes, lemons, oranges, pomelos, etc., have been so far found to suffer chiefly from attacks of stem-borers, leaf-eaters, plant lice and fruit-sucking moth. The stem-borers do damage exactly as in mango but the specific insects are not the same in this case though the habits of the larvæ are similar. The orange borer beetles, of which two species (*Chloridolum alcmene* and *Chelidonium cinctum*) have been noted, are often bad pests in Coorg and Mysore. Of the leaf-eaters the first place should be given to the orange butterfly (*Papilio demoleus*), a black and yellow insect found very commonly all over South India. The dark green caterpillar of this butterfly eats the leaves, and sometimes young plants and tender foliage suffer badly. Besides the orange butterfly there is another tiny caterpillar, the larva of a very small moth (*Phyllocnistis citrella*), which sometimes causes injury to the citrus leaves by mining through the leaf tissue and making the leaves wrinkle and curl up. Plant lice (*Toxoptera aurantii*) of the dark purple brown kind are found now and then in colonies on the fresh shoots of citrus plants, sucking the nutrition and affecting the vigorous growth of the plants; often the affected shoots fade and die. The fruit-sucking moth (*Ophideres fullonica*) is an interesting and rare example of an adult lepidopterous insect causing direct damage to a crop. The moth which is stout and beautifully coloured flies about at night in the orange gardens; a number of these moths settle on the ripening citrus fruits, pierce them by means of their long proboscis, which is supplied with sharp spines, and suck up the fruit juice. As a result the fruits begin to rot and drop down before they ripen fully. In this manner severe loss is now and then sustained by orange gardeners in some years, especially in parts of the Northern Circars. Speaking of citrus pests, we in India might congratulate ourselves that some of the worst pests of citrus trees found in other countries have not yet been noted in India. I refer chiefly to the dreaded Mediterranean fruit fly (*Ceratitis capitata*), a terrible menace to citrus culture in many countries,

and scale insects like the purple and the cottony cushion scales (*Mytilaspis citricola* and *Icerya purchasi*). Of course more than one scale insect has been noted on citrus in parts of South India, but none so far as a serious pest.

Pomegranate. The specific pest of this delicious tropical fruit is the fruit-boring caterpillar of a butterfly popularly known as the pomegranate butterfly (*Virachola isocrates*). The butterfly is one with coppery blue wings and is found fairly common all over South India. The larva is a fleshy dirty brown caterpillar found inside infested fruits, which generally show a hole on the surface through which excrementitious matter is thrown out by the boring larva. An infested fruit when cut open shows many seeds completely spoiled and rotting mixed with excreta of the borer. A hairy caterpillar (*Euproctis fraterna*) sometimes appears on this plant and does some damage to the foliage, but is not as serious as the fruit borer.

Jak. Similar to mango and citrus, the jak tree also suffers from stem-boring grubs; often the mango stem-borer is itself found on the jak tree. Sometimes the shoots and tender leaves are profusely covered with colonies of mealy bugs (*Icerya* and *Pseudococcus*) visited by swarms of ants. These mealy bugs drain the sap and affect the vigorous growth of the shoots. At the time when buds and fruits begin to form, a shoot-boring caterpillar (*Glyphodes caesalis*) and a fruit-borer weevil are seen to do some damage in parts of Malabar, Mysore and Godavari.

Bananas. In South India, as far as we know, the banana plant is not subject to any serious pests. The foliage is occasionally found eaten by caterpillars of sorts—chiefly by a black hairy caterpillar (*Pericallia ricini*), a spiny slug-caterpillar (*Parasa lepida*), and a smooth dark brown caterpillar (*Prodenia litura*). The well known stem-borer of banana (*Cosmopolites sordidus*), a small black weevil which has recently become a serious pest of this plant in Australia, Fiji, etc., though found in a few places in South India, has not yet assumed the status of a serious pest. Lace-wing bugs, plant lice and scale insects are also occasionally noted as minor pests.

Grape. The only insect that might be called a specific pest of grape in South India so far is the grape-vine flea-beetle (*Scelodonta strigicollis*); it is a very small active coppery brown beetle which appears in numbers on the vines and bites holes on the leaves and tender parts of the plant. It has been noted chiefly in Krishnagiri and Penukonda in South India. This insect has not yet gained the notoriety of its American cousin the grape flea-beetle of U. S. A. (*Fidia viticida*). In this connection, it might also be gratifying to note that our vine-yards, though very few worth mentioning, have not yet admitted the dreaded grape-vine Phylloxera (*P. vastatrix*), a very serious pest in Europe and America. When land is not properly worked before planting, grape-vine setts occasionally suffer from the attacks of white ants, just like sugarcane, in some tracts. Cockchafer beetles are occasionally found feeding on the tender foliage at night, and now and then Sphinx caterpillars (*Hippotion* spp.) also do some damage as leaf-eaters. Scale insects (*Pulvinaria* sp. and *Aspidiotus cydonia*) have been often noted on the leaves and shoots also.

Guava. As a rule this plant suffers chiefly from the attacks of a mealy scale (*Pulvinaria psidii*), colonies of which sometimes cover the whole foliage as white mealy masses which are visited by swarms of black ants, the ants often doing greater harm as carriers of the pest; as an after effect a sort of sickly black blight appears on the plant. The fruits are invariably subject to fruit flies, often the same as found on mango. Now and then stem-boring beetle grubs are also found as on the mango tree.

Melons. Fruit flies constitute the main pest of melons of different kinds though now and then a leaf caterpillar (*Glyphodes indica*) and leaf beetles (*Aulacophora* spp.) do some substantial damage. These may be observed in important melon tracts like Kurnool and Cuddappa.

Tamarind. I shall not omit the tamarind although it is not comparable to other fruits mentioned above as a typical edible fruit. It is very common all over South India and is extremely important as an essential material for culinary purposes.

The fruits and shoots of this tree suffer from hard scales (*Aspidiotus* spp.) and mealy bugs.

Of the other fruit trees which are found in different parts of South India but which are as yet of minor importance, we might make mention of fig, pineapple, custard-apple, wood-apple, cashew, sapota, papaya, *Zizyphus* and the bread-fruit tree. Of these, the papaya, sapota, custard-apple and bread-fruit tree have not so far been found to be attacked by any serious insect pests. On pineapples grown in parts of North Malabar I have recently noted on the fruits a mealy bug (*Pseudococcus bromeliæ*), and believe it might have been an introduced pest. The wood-apple fruits are often bored by caterpillars which spoil the fruit pulp, and the foliage is eaten by the common nettle grub caterpillar. The edible fig, of which we have hardly any crop worth mentioning in South India, has been found subject to the attacks of stem-boring longicorn beetles [of which there is one (*Olenecamptus bilobus*) special to fig] in the same way as in mango and jak. On the foliage a slender ashy grey caterpillar (*Ocinara varians*) and some greyish weevils are noticed frequently. Mealy bugs and scales also occasionally appear on the fruits and tender shoots. *Zizyphus*, which is very rarely found cultivated, suffers chiefly from the attacks of a fruit fly (*Carpomyia vesuviana*) and one or two caterpillars infesting the fruit. Though these are at present of minor importance, it is not unlikely that some of the finer varieties of *Zizyphus* which are now being tried in some orchards might be liable to the attacks of these pests causing some notable injury.

Coming to the insect pests of introduced fruit plants like apples, pears, nectarines, plums, etc., which are chiefly grown only on the hills and upland tracts, our knowledge is much more imperfect. On apple plants grown on the Nilgiris and Shevaroy's the woolly blight (*Schizoneura lanigera*), a very destructive pest of apples in Europe and America, has already gained admission, and is beginning to assert itself.

Though it is not the object of this paper to add anything in the way of control measures against the various insects noted above, for the obvious reason that very little work has been done in that

direction, it might not be out of place here just to indicate in a very brief manner some of the main principles upon which all such control measures may be more or less based. All insect pests of fruit trees—for the matter of that all insects—can be brought together under two main groups according to their feeding habits, *viz.*, those that damage the plant tissue by biting and chewing, called biting insects, and secondly those that affect the plant not by biting or chewing, but by sucking up the plant sap from the tender portions, known by the name sucking insects. Under the first category we might include the different kinds of stem and fruit-boring larvæ and leaf-eating caterpillars and beetles. In the latter group we have the mango hoppers, the citrus plant lice, scale insects, mealy bugs, the fruit-sucking moths and other bugs sucking the sap from the tender portions of the fruit trees. Except in certain special cases, all control measures depend a good deal on the above grouping, which, of course, pre-supposes a knowledge of the food habits of each pest. And this is particularly so when insecticidal methods are concerned. For all borers inside the stem, shoot and fruit, a direct curative measure like the application of insecticides is impracticable in most cases, as the creatures are internal feeders ; so, only such preventive methods as will check the multiplication of the pest are practicable in such cases—such as pruning the affected branches, cutting down and burning dead and dying stems, and destroying infested fruits. In some cases where beetle or moth larvæ bore into thick stems of trees, they may be pulled out by a hooked wire, or killed by injecting a poisonous mixture by means of a syringe. For fruit flies, however, the only possible methods as far as we know at present are destroying infested fruit and trapping the adult flies by poisoned syrup. In the case of leaf-eaters like caterpillars and beetles, they can be easily collected and destroyed by simple mechanical means, or if insecticidal methods are demanded, which will rarely be the case so far as we know at present, a poisonous mixture can be dusted or sprayed on the foliage on which the insects feed. The particular class of insecticides used in such cases is called a stomach poison and this is the kind generally used against biting insects : the poison.

mixes with the food and poisons the insect. The common stomach poisons known are Paris green, lead arsenate, zinc arsenate, etc. For the other class of insects in which we include mango hoppers, mealy bugs, scales, plant lice, etc., insecticidal methods will be found more practicable and effective. The kind of insecticide used in the case of most of these insects which are sucking in habits is called a contact poison; contact poisons generally affect the insects chiefly by external irritation and closure of the respiratory holes; such an insecticide does not mix with the food of the creature. Among the well-known contact washes used are fish-oil soap, crude oil emulsion and tobacco decoction. Spraying experiments carried on against the mango hopper pest¹ with such washes in different parts of India have been found effective, and this method is becoming popular. For plant lice, mealy bugs and scales also such an application will be found effective. As stated before, peculiar pests like the fruit-sucking moth and bugs might require special methods based on common sense and experience, such as covering the fruits, trapping the insects, etc., etc. There is little doubt that insecticidal methods of pest control always play an important part in orchards, since some of the most destructive of fruit tree pests appear to be sucking insects—scales, mealy bugs, hoppers, plant lice, etc. That numerous scale insects are found on all kinds of fruit trees may be made out not only from foreign publications on fruit culture but even in India it is the case, *vide* my paper² on “Coccidæ affecting fruit trees in South India.” As such, every fruit-grower who wishes to carry on his work on scientific and successful lines will do well to stock some of the important appliances and materials necessary for carrying on insecticidal methods of pest control whenever wanted. Among these may be mentioned a knapsack spraying outfit, a brass syringe with a long spout for treating borers in stems, one or two hand nets, and a small stock of insecticides like Paris green, lead arsenate, fish-oil soap and crude oil

¹ *Tropical Agriculturist*, LI, July 1918.

² *Report of the Proceedings of the Third Entomological Meeting held at Pusa, 1919*, pp. 601—610.

emulsion. These may be considered as essential things for a gardener in the same manner as are his garden implements. In speaking of control measures, I may add as a general statement that the economic entomologist who has to deal with fruit insects has a most favourable field where some of the methods of applied entomology could be profitably demonstrated to farmers and their confidence easily gained.

Selected Articles

THE CLASSIFICATION OF SUGARCANE VARIETIES.*

THIS paper¹ is a serious attempt to lay the foundations for a modern and up-to-date classification of canes. In a recent issue² we dealt with the introductory paragraphs, on deterioration of cane varieties, bud selection, flowering of the cane, ripening, and the spoiling of the cane juice after cutting, but left out those on the soils of Porto Rico, the history of cane introduction into the island and long ratooning, as rather of local than of general interest. In the present note we propose to confine ourselves to Earle's main thesis, the botanical study of the cane as laid out by him.

In the "Species Plantarum," published in 1753, Linnæus included two forms under "*Saccharum*, *S. officinarum*, founded on thick-stemmed tropical canes, and *S. spicatum*, a wild grass; but the latter, not being a true *Saccharum*, has been excluded by modern authors. Earle traces the rapid addition of supposed species by subsequent authors, till, in 1833, Kunth in his "Enumeratio Plantarum" lists 22 forms besides varieties, while Roxburgh in his "Flora Indica" gives 11 as occurring in India alone. Later critical revision, however, again reduced the numbers, till in 1887 Hackel in his monumental revision of the grasses in Engler and Prantl's "Pflanzen Familien" recognizes 12 species of *Saccharum*, while Hooker in the "Flora of British India" (1897) gives only 5 as indigenous in that country. Both of these authors separate the genus into groups, in the first of which, *Eu-Saccharum* or true sugarcanes, are placed *S. officinarum* and *S. spontaneum*.

* Reprinted from the *Inter. Sugar Jour.*, No. 283.

¹ Earle, F. S. Sugarcane Varieties of Porto Rico, II. *Jour. Dept. Agri. Porto Rico*, V, No. 3, July 1921 (issued 1922).

² *Inter Sugar Jour.*, 1922, pp. 236-239 (*Agri. Jour. India*, XVII, p. 587).

After this summary, Earle concentrates his attention on these two species. He quotes Barber (1915) as demonstrating the great variability of *S. spontaneum* in India and its close connexion with the various groups of indigenous canes of North India, and attributes to that author the idea "clearly indicated if not openly advocated" that all cultivated sugarcanes, whether thick-stalked (tropical) or thin-stemmed (Indian), are really descendents of this wild form. It may be permitted to the writer of this note to point out that Barber, in subsequent papers not apparently seen by Earle, was not successful in his attempt at tracing a clear line of succession from *S. spontaneum*, through the primitive Indian canes, to the thick-stemmed canes of tropical countries, and finally came to the conclusion that the evidence appeared to him rather to point to two separate lines of descent of cultivated sugarcanes, the Indian canes, on the one hand, arising in India from an ancestor similar to, if not identical with, *S. spontaneum*, while the tropical forms, on the other hand, appear to have had a separate origin in the islands of Polynesia from a closely applied species now probably extinct.¹ This question of the origin of the thick and thin-stemmed cultivated canes, which differ markedly in certain respects, cannot, however, be considered as closed, at any rate until a detailed scientific study has been made of the large collections of cane arrows known to exist (e.g., the mass of material collected at Coimbatore). Such a study is highly desirable, as the results would be founded on a true botanical basis, and might throw important light on the matter.

After tracing the variations in the number of species recognized by the chief botanical authorities at different periods and the chief differences between *S. spontaneum* and *S. officinarum*, Earle turns to recent advances in the description of canes, and singles out the work of Barber in India, dealing chiefly with Indian forms, and Jeswiet in Java, whose material was mostly of tropical kinds. He considers that the work of these two authors "has laid a broad and secure foundation for the study of sugarcane taxonomy,"

¹ *Inter. Sugar Jour.*, 1920, pp. 249—251.

adding that in his opinion "for the first time we have descriptions of cane varieties that are sufficiently full to permit of sure identification." Of the two he selects the work of the former as better fitted for his purpose and "more nearly conforming to ordinary botanical usage," pointing out Jeswiet's remarkable method of "dividing the parts of the bud and other regions of the plant body into serially numbered areas for purposes of description, especially for noting the presence or absence of plant hairs, seems to introduce an unnecessary complication" although "followed in this by Fawcett of the Argentine Sugar Station, who has recently published some most useful cane descriptions." He accordingly, in the detailed descriptions of the Porto Rico canes, follows "as closely as may be the terminology of Barber in the hope of standardizing cane descriptions," although expressing a doubt as to the usefulness of the detailed measurements of the length and diameter of different parts "since these factors are so greatly altered by conditions of growth and environment." As will, however, be seen below, the use of these characters is inevitable.

The following is a summary of the points selected by Earle as of special importance in describing different varieties of cane :—

1. *General habit.* Whether the plant is erect or soon prostrate, stooling lightly or heavily, general vigour and propensity to arrow.

2. *The stalk as a whole.* Average diameter, colour and bloom.

3. *The character of the internode.* Comparative length, general form, the presence or absence of the groove and its character when present.

4. *The node.* Whether this is constricted, even or prominently enlarged, and whether it is placed at right angles or obliquely to the length of the stalk. Under the node should be considered the characters of the growth ring, root band, leaf scar and glaucous band (bloom band).

5. *The bud.* This gives characters of greater taxonomic importance than any other part of the cane, although it must be recognized that the bud varies at different ages and stages of development and judgment and experience are required in the

selection of typical ones. Under this heading Earle notes the form of the bud, its apex, the flat sterile margin, the point of germination (where the new shoot appears), the average size especially in relation to the other elements of the node, and the presence or absence of hairs, especially at the base, on the sides and at the apex.

6. *The leaf-sheath.* The presence or absence of sharp, stiff hairs over the surface and their relative persistence, the occurrence of wax or bloom, and the general tone of colour. In the leaf-sheath, the throat, collar, ligule and the ligular process or processes should be noted.

7. *The leaf-blade.* Its general position, whether spreading, strictly erect or erect with declined tip: the colour, measurements, character of the serrations on the margin, and the hairs or cilia near the base.

8. *The inflorescence.* A full description^r should include the arrow, but these have not been studied for the Porto Rico varieties described in the paper, being only in a suitable condition for a very brief period and, in many cases, seldom or never being produced. For practical purposes it seems best to ignore the characters afforded by them, although taking note of the tendency or the reverse to free arrowing.

In the list of cane varieties recorded for Porto Rico, covering 91 pages, all the information which Earle has been able to accumulate during his studies is set forth under each variety. This information covers a very wide range and includes its source or origin, occurrence in the island, value agriculturally, vigour and comparative susceptibility to various pests and diseases, synonymy, chemical constitution, adaptability to various conditions, tonnage, ratooning power and so forth. A detailed description is given in simple botanical language, on the lines noted above. As an example of the latter, we have chosen *Cristalina* (White Transparent or Light Cheribon) as perhaps the most widely distributed and useful variety; as the author puts it, "as indicated by long experience, not only in Porto Rico but in all parts of the world, this is one of the best varieties for general planting and one of the very few on which it is safe

to base the entire sugar industry of any region." The following is his description of it :—

"Erect, then declined, vigorous, a good stooler, arrows freely at some times and on some soils, under other conditions it seldom arrows. Stalks medium diameter, green, usually with a strong pink flush, bloom heavy. Internodes medium length, cylindrical or somewhat tumid, straight or slightly staggered, furrow evident, of medium depth. Nodes oblique, constricted; growth ring yellowish green, conspicuous, elevated; root band narrow, oblique, slightly constricted, rudimentary roots small, inconspicuous, pallid with brownish centres, in about three rows; leaf scar glabrous, wide in front, adpressed behind; glaucous band constricted, rather narrow, not very conspicuous, blending with the bloom of the internode. Buds medium size, triangular-ovate with rounded base, exceeding the growth ring, margin wide, strongly shouldered below, germination apical, base and apex adpressed ciliate. Leaf-sheaths glabrous, greenish, quite glaucous; throat densely lanate and with abundant long coarse hairs; collar conspicuous, reaching the midrib, lanate throughout; ligule medium width, margin even; ligular processes usually only one developed. Leaves abundant, spreading, flat, medium length and width, about 7 cm. bright green, minutely serrulate, the margins at base ciliate for two or three inches."

After the conclusion of the description of the varieties grown in Porto Rico, lists are given of those kinds which, from the present state of knowledge, are considered as the best for general planting, for moist well drained alluvial soils and semi-poyals (semi-marshes), compact poorly drained maritime soils and clay alluvium red hill lands, lands with lime sub-soil, and salty lands. Also lists of very early maturing canes, canes to hold over for long crop, and canes to plant in districts infected with mosaic.

Then follows one of the most ambitious features of this important paper, namely, a key founded on the botanical descriptions already given, by means of which it is comparatively easy for those accustomed to such work to run down a cane and give it its correct name. As far as we are aware, the author has been the first to attempt this with the sugarcane varieties of a tract which have been

adequately described ; he published a tentative key in the first paper of this series of three,¹ but as this was before he had seen the later morphological work on which the present descriptions are founded, the key has been recast in his present paper. This is a notable botanical achievement as regards the classification of sugarcane, and brings it into line at last with the botanical work on other crops which have received a thorough scientific study. For those unaccustomed to use a key, the author gives a series of useful hints.

From the foregoing we conclude that, right or wrong in matters of detail, the intrinsic importance of Earle's contribution towards the difficult and intricate problem of the classification of sugarcane varieties lies in the following :—

(1) A thorough and up-to-date study has been made of the multitude of cane varieties collected in one tract. (2) A careful analysis of the synonymy of these as compared with the canes grown in other countries often under different names has been made wherever possible. (3) A well chosen selection is offered from recent morphological work of those botanical characters which appear to him to be of taxonomic importance and of easy recognition in the field, and on these a useful botanical description is based which has been compressed into a moderate space. (4) An analytical key has been prepared, in which some of the leading distinguishing characters are emphasized, and by which varieties can be named and then checked with detailed botanical descriptions.

It is however to be noted that the author by no means claims that this is the final word in the matter. He offers his work as a sample which may be useful to workers in other tracts, in which of course the material to be dealt with will differ in many respects. In such studies, as new forms come under review, there are certain to be local changes in the relative value of distinguishing characters ; for botanical features which are stable under one set of conditions and in one country have been proved to be less so, at any rate at first,

¹ Earle, F. S. Sugarcane varieties of Porto Rico. *Jour. Dept. Agri. Porto Rico*, III, No. 2, April 1919.

when transferred elsewhere. This was the case with canes grown for a century in South India, where they exhibited a strictly limited range of coloration, but when taken 1,500 miles north developed new shades ; and similar facts have been noted in richness of juice and vigour of growth, which in certain introduced forms deviated considerably from the normal for the first four or five years after change of locality, and then gradually assumed their usual values in these respects. The leading idea is thus *the intensive study of the canes existing in a definite tract* and thoroughly acclimatized in it. The greatest obstacle hitherto existing to the evolution of a system of classification of sugarcane varieties has been the feeling that larger and larger collections of varieties grown elsewhere were necessary before such work could be commenced. Earle has shown that this is no valid reason against such work being undertaken. This is a great step in advance, and the way is now open for a botanist in any tract to examine his local material and publish a synopsis of the cane varieties grown there. We need not await the accumulation of vast collections of canes derived from all over the world before starting descriptive work ; and it seems to the writer, from the facts mentioned above regarding the instability of newly introduced forms, that a better result is likely to be obtained by a series of isolated surveys of thoroughly established forms. Such local studies of the material at hand have the advantage of proving immediately useful to the planters of the tract, and the new forms arriving can be readily worked in as soon as they have become acclimatized and have proved worthy of consideration. A complete classification of the world's sugarcanes is at present unobtainable but, with a gradually increasing number of such individual surveys, should not be impossible to the well trained systematic botanist of the future. [C. A. B.]

NEW WATER SELF-RAISER.*

EFFICIENT METHOD OF USING LOW HEADS.

AN apparatus has been erected in a river in Surrey which has created the greatest interest in the scientific world. It is the invention of an English engineer, Mr. T. G. Allen, of the Allen Hydrostatic Pump Syndicate, Ltd., of London, and consists of a self-operating means of lifting water in any quantity to any desired height without the use of any moving parts except an inlet and outlet sluice-gate. It is entirely self-contained, and provides its own motive power by the employment of two natural sources of energy—the weight of a column of water and the pressure of the atmosphere.

The operation is continuous and the plant requires no housing, attention, or supervision. It may be built of timber, steel, or concrete, or any water-tight material, and is of very simple construction. The water is pushed and pulled upwards by successive impulses. One is that of automatically compressed air. The other the pressure of the atmosphere working against a vacuum. These impulses are self-induced, and follow each other in continuous alternations.

SMALL FALL.

In all countries there are large streams on which hydraulic power developments are not feasible, owing to the small amount of fall (or "head") available for driving turbines. It is axiomatic that the lower the head the greater the cost per horse-power developed. In all countries there are arid or semi-arid areas, but the local conditions, plus the cost of pumping, have made irrigation impossible. At other points there are tides which cannot be economically used for power on account of the enormous expenditure involved.

In each of the above cases there may be ample water, but the water is not in the right place. The farmer on the hillside is ruined

* Reprinted from *Engineering Supplement to the Overseas Daily Mail*, dated 16th September 1922.

by drought while he looks down at the river in the valley. The tides ebb and flow, with their stupendous energy still unharnessed. The river glides to the sea and, because its fall is so gradual, turns nothing but a few millwheels.

These are the cases, or some of them, to which the "Hydrantomat" is directly serviceable. Furthermore, it is the only thing that can serve. Nor has the progress of scientific research yielded anything so far which has a parallel application. It would not be applicable did not the theory march in step with the great forces of nature, and draw from them both its simplicity and efficiency.

Take the case of a river on which there can be had a head, say, of 6 ft. This head may be developed very cheaply, especially if it is only desired to use a part of the flow for motive purposes. In this example the upper level is the headrace, the lower level the tailrace, and there are six vertical feet between them. At the half-way point, or lower, a closed tank is constructed, proportionate in size to the capacity of the apparatus. This is called the operating chamber, and it is supplied with an intake pipe from the headrace, and from it there goes a discharge pipe to the tailrace.

SERIES OF TANKS.

Above it a flight of alternating closed and open tanks is constructed, which may either be above one another or placed like a staircase. These tanks are inter-connected by water-sealed supply pipes. Each of the closed tanks is, in addition, coupled to the operating chamber by an air conducting pipe. The combined capacity of the closed tanks is equal to that of the operating chamber. From the top a duct conveys the lifted water to the desired point.

Operation is confined to two strokes : pressure—then suction.

Pressure is created by the weight of the water column which flows into the operating chamber from the headrace. Its effect is to compress the air in this chamber, and force it out along the air-conducting pipe, whence it enters the overhead closed tanks. The effect here is that the water in these tanks (which has been lifted by the preceding stroke) is, in its turn, forced out, and pushed up through the connecting pipes into the next tanks. These are open

ones. This water cannot escape downwards again, as the open end of the pipe by which it has come is slightly above the surface at the completion of this stroke. The compressed air, therefore, can only force the water upwards. One flight is thus accomplished. At the end of this pressure stroke the operating chamber and open tanks are full of water, but the closed tanks are full of air.

Suction is governed entirely by the normal pressure of the atmosphere on the earth's surface. The contents of the operating chamber are automatically drawn down and discharged into the tailrace. Simultaneously the inlet valve from the headrace is automatically closed.

A vacuum is thus created in the operating chamber, and this vacuum extends to all the higher closed tanks through the medium of the air-conducting pipe. In consequence the water in each open tank (these being now full) is sucked up one flight into the next higher closed tank. At the end of this suction stroke the operating chamber and open tanks are empty, and the closed tanks are full of water. The inlet from the headrace is then automatically opened, pressure water readmitted, and the pressure stroke recommenced.

The pipes between the tanks are all water-sealed, so that all non-return valves or mechanical checks are dispensed with and the downward escape of compressed air is prevented. Thus the conducting pipe only transmits the actuating agent from the operating chamber, in which that agent is developed. First, as compressed air, it forces water up one flight from the closed tanks into the open ones. Next, by the pull of a vacuum, it draws the water up a further flight from the open tanks to the closed ones. There is no escape from this sequence. It is a matter of push and pull.

The "Hydraulomat" is automatically primed. A cock is inserted in the conducting pipe between each of the closed tanks. These cocks sectionalise the apparatus. Also there is placed on the operating chamber an air vent, used only in priming. When the chamber is entirely empty this air vent is opened and operating water admitted. The air vent is then closed, as also the cock between the two first closed tanks. The operating chamber being

then discharged, a vacuum is formed, and the lowest closed tank at once filled from the source of supply. The next stage is accomplished by opening the next cock in the conducting pipe, and so on until the system is entirely primed.

The system is equally effective at both low and high lifts, and at no point is there more than a few pounds pressure per square inch, no matter what the height of delivery may be. In the example quoted the maximum pressure is less than $1\frac{1}{2}$ lb. per square inch. This is an important advantage. The height required is reached by carrying the series of closed and open tanks, together with the air-conducting pipe, to the desired point.

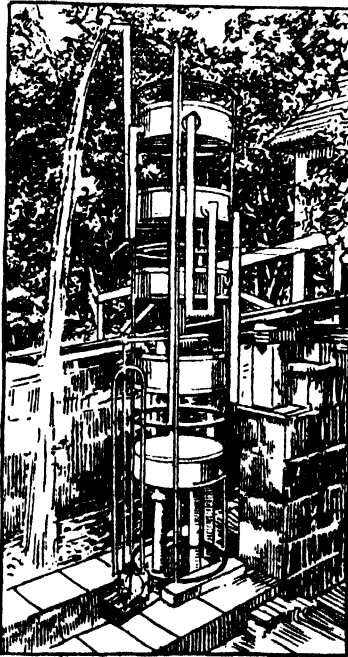

Installation in river at Carshalton.

In the "Hydrautomat," as erected and running at Carshalton, the arrangement is equally simple but differently applied. The long invert of the discharge pipe has been eliminated, and it ends just beyond the first bend. Here is placed the outlet sluice, itself being in balance with the inlet sluice controlling the entry of water to the operating chamber. From the bend a small pilot siphon is

led, and discharges into a self-draining bucket connected by wire cable with the inlet control.

On the completion of the pressure stroke this bucket is filled by the pilot siphon, and by its weight opens the outlet. At the end of the suction stroke, the bucket, being now drained, is over-weighted by the inlet sluice and rises, thereby closing the outlet from the operating chamber. This very simple action maintains the positive action of both inlet and outlet.

EXCESS AIR.

It will be observed that in the above example one portion of a stream elevates another portion of itself. But this is in no way essential. The "Hydrautomat" may conveniently take pressure from a muddy river in order to lift the clean flow of an adjacent spring.

It was found, as had been anticipated, that unless special provision was made there would be a small but constantly increasing addition to the air column in the "Hydrautomat," due to the fact that air bubbles must often be carried in by the operating water, and also as the result of the liberation by agitation of some of the air contained in water itself.

To meet this, a simple arrangement was devised by means of which the excess air when it collects is automatically discharged and the air column kept at exactly the right length. This relief only comes into action when excess air has accumulated. The remaining air is reduced to atmospheric pressure just before it is rarefied by the suction stroke.

The principle of the "Hydrautomat" admits of its being constructed in various forms to suit requirements. In addition to the design shown in the illustration, it may be built in the shape of a self-contained tower, a stand pipe, or silo. In this case there are merely successive sections, separated by floor without any air spaces between. The piping may be all inside, and itself be of concrete—or even glazed tile.

Another very simple method is to arrange the "Hydrautomat" in successive steps on a hillside, and place most of the piping under-

ground. It will be understood that the operating chamber may be installed at a considerable distance from the open and closed tanks. This involves merely the lengthening of the conducting pipe.

The photograph taken at Carshalton (see Text-figure) is during the pressure stroke, with water issuing from the delivery.

EFFECT OF LEAKAGE.

It will be understood that the rapidity of the cycle depends entirely on the speed with which the operating chamber is filled and emptied and is merely a matter of pipe sizes, given a suitable supply of water.

In this illustration can be seen the small pilot siphon referred to, which fills the self-draining bucket.

The siphon is not in action, because the apparatus is on the pressure stroke, and the water in the operating chamber has not risen high enough to make the siphon discharge.

Should any leakage occur in the "Hydrautomat," the operation will not be stopped, but only affected in proportion to the size of the leak. If this is the escape of air outwards on the pressure stroke, it means that, while less water is being delivered, there is also less air to be exhausted before what remains is rarefied by the suction stroke. If an excess of air is sucked in during the latter, it means that this excess will be automatically vented at once by the air relief attachment previously mentioned.

The "Hydrautomat" converts the contained energy of large quantities of water at a low head into that of a smaller quantity of water at a high head, and may be used to compel a stream to hoist part of itself up over the land for domestic or agricultural purposes. The invention is of the greatest simplicity, but patent rights in all the principal countries of the world have been granted after keen investigation for prior claims.

CO-OPERATIVE MARKETING OF COTTON.*

THE ECONOMIC SALVATION OF THE SOUTHERN STATES OF AMERICA.

A FEW years ago some enterprising, possibly satirical, citizens of Anniston, Alabama, erected a statue to "The Economic Saviour of the South"—the much-hated Mexican boll-weevil. The boll-weevil, said the citizens of Anniston, had forced the farmer of the South to plant something besides cotton. Nowadays he is putting in crops of corn, water-melon, peas, sweet potatoes, and a lot of other things. He is raising hogs, and getting good prices for them; trying his hand at fruit-growing, truck gardening, and in a number of ways repairing the ravages of the cotton pest.

The same system of cynical philosophy may some day inspire another group of citizens in some other cotton town to erect a statue to the "street buyer," the bane of cotton-growers—a clever, skilful individual, who has made his living by inspecting the cotton a farmer brings to town, buying it from him and selling it himself for a little more. For the "street buyer" and the cotton broker are admittedly two of the main reasons for the co-operative marketing association plan now sweeping the South.

Co-operative marketing is nothing new in the North and North-West, where reforms of an agrarian nature as well as of a political nature have been the rule rather than the exception for ten years. But the South, by tradition, is conservative, politically; economically the tendency is even more pronounced. The growth of the co-operative movement among the Southern farmers is all the more interesting.

A SUCCESSFUL EXPERIMENT.

The farmer has for years been fed on the fable that the principles of co-operative marketing were successfully applicable to minor crops, fruits, truck products, but not to the big crops, the market

* Reprinted from *The Manchester Guardian Commercial*, dated 17th August, 1922.

for which was world-wide and the supply derived from a large area. So the cotton farmer stood idly by, his own crop subject to the most violent fluctuations of a speculative market, and watched his neighbour with cantaloupes, cabbages, peaches or pecans sell through a co-operative body, receive excellent profits, and have a nice balance in the bank.

At length the cotton farmer began to question the view that major commodities could not be marketed in common. He studied the various factors of the situation, and came to the conclusion that the way he and his neighbours over the eleven cotton States rushed to market each fall with their fleecy staple cut prices on the exchanges, and trimmed their own profits to the bone. He became convinced that his cotton was worth just a little more than the factors and buyers allowed him. He became insurgent.

Oklahoma started the ball rolling. In 1921 progressive growers of that State organized the Oklahoma Cotton Growers' Co-operative Association. It was an experiment, and there was much opposition to it; yet in that year the association handled about 90,000 bales, for over \$15,000,000, established warehouses, staffs of grading experts, pools of various grades of staple, and gained a foot-hold—all without a cent of paid-in capital. Their success was noised about. Planters in Alabama, Georgia, Mississippi, Texas, Arkansas, the Carolinas, pricked up their ears. They investigated, and became convinced. New associations were organized with rapidity; over 120,000 farmers signed the association contracts, and this fall the American Cotton Growers' Exchange, an affiliation of all these State groups, will enter the market with approximately 2,500,000 bales of cotton under control of its members.

IRONCLAD CONTRACTS.

These State associations are alike. They make a long-term, ironclad contract with the grower for all the cotton he raises. If he fails to deliver it to the association a severe penalty is attached. When the cotton comes to the association each bale is graded and pooled in grades; the average price a certain grade or lot brings over the season is that paid to the farmer. Thus the grower

receives the price to which his cotton quality entitles him, and he is not penalized because his cotton came in late. The system of internal pooling ensures for each farmer the same price for the same quantity and quality, regardless of time of delivery or sale. The cotton gets into the hands of experts when it reaches the association. They grade, class, and sell it for the farmer, instead of working against him, as the brokers and street buyers in the very nature of things are forced to do.

Financing methods have been worked out and tested. In Oklahoma, for instance, the farmer delivers his cotton to the nearest gin, where he gets a receipt for it. The gin ships it to an association warehouse. The farmer can take his shipping receipt to his local bank and borrow ten cents a pound on it. After a little time the association reimburses the bank for that loan from funds it has secured from the clearing houses or War Finance Corporation. The farmer does not receive the rest of his money for the cotton until the selling season ends ; but he has been taught that the delay is to his advantage, because the gradual release of the cotton prevents a break in the market and a consequent crash in prices.

In the short life of the movement several points have been demonstrated. Mr. Carl Williams, President of the American Cotton Growers' Exchange, defines them thus :—

1. They have proved that average farmers will sign and abide by long-term, ironclad contracts. More than 125,000 cotton farmers have already signed these contracts.

2. They have proved that such organizations can be financed on a basis of commodity collateral for the purpose of orderly sale.

3. They have demonstrated that expert service can be performed by the employees of farmers' organizations just as well as by those of private corporations. The four State associations now active are handling more than \$50,000,000 worth of cotton this season, and are doing it efficiently, sanely, and on the approved principles of city business.

4. They have eliminated waste, inefficiency, and speculation at country markets. They have practically eliminated country damage through a system of prompt warehousing, and other damages

through blanket insurance. They have substituted knowledge for ignorance in the dealings of the farmers with the buyers of cotton.

NOT A PANACEA.

Mr. Williams does not think that the co-operatives are a panacea for all agricultural ills, nor that they are designed to combat the law of supply and demand. "They are specific associations for orderly marketing, and shortening the route between producer and spinner," he says. "They declare no war on anyone; they are in search of the high dollar for cotton. They are working in harmony with a large percentage of the big cotton exporters and brokers."

Just to show what the co-operatives have done, the following figures, reported at a recent meeting of the Board of Trustees of the Exchange, at Birmingham, Ala, is illuminating:—

<i>State</i>	<i>Members</i>	<i>Bales</i>
Oklahoma	36,000	425,000
Texas	19,100	552,000
Arkansas	5,900	215,000
North Carolina ..	27,000	400,000
South Carolina ..	9,187	423,000
Georgia	13,000	268,000
Alabama	6,000	100,000
Arizona	1,000	50,000
TOTAL ..	127,187*	2,453,000*

*The totals are apparently incorrect, but they are as shown in the original.

In May the Clearing House Association of Little Rock agreed to put up \$3,000,000 to help the Arkansas Co-operative financing. The Atlanta banks in June put up \$5,000,000 for the Georgia Association. The War Finance Corporation is doing its share. There is no trouble in regard to the financing.

This fall will see the co-operatives for the first time a sizeable factor in the cotton market as a whole. Hitherto it has been experimental. The fall of 1922 may see it become a real force in the cotton-growing industry. The South is watching it with the greatest hope, for cotton, after all, is still king, notwithstanding the pretenders to his throne.

VITAMINS.*

THE Sections of Physiology and Agriculture of the British Association held a joint discussion on vitamins at Hull on Friday, 8th September, 1922.

Professor J. C. Drummond spoke of the great strides that have been made since the discovery of the vitamins by Hopkins in 1912. Both the existence and the indispensability of these substances are now generally accepted. The far-reaching importance of the qualitative composition of the diet of man and animals is being gradually appreciated, and the significance of those factors which exist in extremely minute amounts recognized. Three substances of the so-called vitamin class have been differentiated with certainty and it is possible that more exist. They do not appear to be of one chemical type, and the only ground for grouping them together is that they occur, and are effective, in very small amounts. Parallel examples from the inorganic food constituents are known, such as the value of minute doses of iodides in the treatment and prevention of foetal athyrosis in swine.

The green tissues of plants would seem to be the chief site of vitamin synthesis, although lower forms of plant life devoid of photocatalytic pigments can apparently produce the vitamin B. Plant tissues undoubtedly form the direct or indirect source of the vitamin supply of animals, but we are entirely ignorant as to the rôle of the vitamins in the plant itself.

Storage of the vitamin A may take place in the tissues, liver, and body fat of animals, and may serve as a reserve from which are drawn supplies to maintain vitamin concentration of milk if the diet during the lactation period should be deficient.

In collaboration with Dr. Zilva a prolonged investigation of the origin of the large stores of vitamin A in cod-liver oils has

* Reprinted from *Nature*, No. 2767.

recently been made. It has been ascertained that the marine diatoms synthesise the vitamin, and that it is transferred to the tissues of minute animals (plankton) which thrive on the unicellular plants. These in turn form the food supply of larger species, particularly small fish, which in their turn are devoured by the larger fish, such as the cod. Through all these stages there is apparently a transference of the vitamin, ending finally in the storage in the liver of the cod. The modern methods of manufacture of cod-liver oil do not appreciably lower the vitamin value, but there are wide variations in the value of different samples which are probably connected with the seasonal changes in the feeding habits or physiological condition of the fish. Considerable work has been done on the chemical nature of the vitamin A, but an isolation has not yet been made. It is very stable, except to oxidative changes, and passes into the unsaponifiable fraction of the oil. Cholesterol, pigments, and other fractions of this fraction may be removed without loss of potency.

Captain J. Golding gave a number of illustrations of the value of the application of vitamin theories in practical pig-feeding. Frequently the usual type of pig diet is deficient in vitamins, particularly vitamin A, and the beneficial influence of cod-liver oil or of feeding on pasture or lucerne in such cases is remarkable. In the compounding of rations care should be taken to ensure an adequate supply of food-stuffs rich in vitamins, otherwise there is danger of sub-normal growth, impaired resistance to infections, and disturbances of the power to produce and rear normal young. The majority of the cereal products are deficient in vitamin A, and the amount in the diet is not raised much by the use of separated milk. Such diets can be supplemented by small additions of cod-liver oil, 1—2 oz. daily for full-grown pigs, or by access to pasture. Cod-liver oil is also valuable in maintaining the vitamin value of the milk yielded by cows on winter rations in stall, which otherwise tends to fall. The administration of cod-liver oil, if of good quality, does not produce flavour or taint in pigs or milk and butter.

Dr. Atherton Seidell (New York) described his attempts at the separation of the vitamin B from yeast by chemical methods. By

adsorption of the vitamin from yeast extracts on to Fuller's earth, and extraction of the activated solid with alkalies under suitable conditions, considerable concentration of the active substance could be effected. The resulting extract when fractionated by precipitation with silver salts gave active fractions, but these have not yet yielded a pure substance.

Professor W. D. Halliburton referred to the need for caution that enthusiasm for a new word such as vitamin did not overwhelm the importance of other dietary units. There must not be a loss of perspective in viewing the function of these newly discovered substances. There is also need for further research on the nature of the substances (auximones) which are believed to act as vitamins for plant growth.

Dr. Monkton Copeman agreed with the importance of vitamins for the young and growing organism, but questioned whether they are as important, or not actually deleterious, to the mature animal. In some researches which had recently been made under the auspices of the Ministry of Health, evidence had been obtained that patients suffering from malignant growths had received benefit from a course of feeding on dietaries deficient in vitamins. There was also a definite, if microscopic, fall in the Registrar-General's figures for cancer during the years of the War, when food restrictions were in force.

Notes

STATISTICS OF THE MILK-SUPPLY OF BOMBAY CITY.

IN 1915 Dr. H. H. Mann, at the request of the Municipality to examine the milk-problem and make his recommendations for improvement, had the statistics of the milk-supply worked out.

In June 1922, a systematic survey was made of the city's milk-supply by the writer, and the following figures may prove of considerable interest both to the general public and to those engaged in the study of the milk-problem in this country.

The total quantity of milk consumed per day in Bombay amounts to 22,997 gallons, *i.e.*, 229,970 lb. As the population of Bombay, according to the last census, was 11,75,914, the consumption of milk per head works out to 3·1 oz. This, as will be admitted, is not what it should be, especially in a country like India where milk forms one of the principal articles of diet both of the rich and the poor.

Out of the total quantity, 18,000 gallons of milk, *i.e.*, 78 per cent., are produced within the municipal limits in the town-stables. Of the remaining quantity, 4,855 gallons, *i.e.*, 21 per cent., are brought by rail from the suburbs and beyond. The farthest place from which milk is brought by rail is Kirkee on the G. I. P. Railway and Nadiad on the B., B. and C. I. Railway. The remaining 142 gallons, *i.e.*, one per cent., are brought to Bombay from the suburbs by road.

There are in all 93 milch-cattle stables in Bombay City and these contain in all about 15,000 head of cattle. Of this number about 95 per cent. are milch-buffaloes and the rest are cows.

The above figures compare unfavourably with those collected for Dr. Mann in 1915. It was then estimated that about 20,000 milch animals were stabled in the city. Out of the total supply of milk 83 per cent. was produced in the town-stables, while 17 per cent. was brought from outside. The total quantity of milk

consumed per day in the city was estimated to be 30,000 gallons, and in view of the fact that the population then was smaller than what it is at present, the consumption of milk per head was higher than that of to-day.

This state of affairs may be attributed to the rise in the cost of food-stuffs which leaves a poor margin of profit to the cattle-owner. The increased railway freights have not only added to the cost of milk-transport, but also have added to the initial cost of the animal, and with the prevailing lack of funds all round, inferior types of animals are now being purchased. The high rent of city-stables ranging from Rs. 3-8 to Rs. 8 per month per head, the slaughter of prime animals after they run dry and the destruction of the calves of class animals stabled in the city are other factors which have tended to accentuate the difficulty. [ZAL R. KOTHAVALA.]

* * *

TESTING COTTON FIBRES FOR STRENGTH.

THE Textile Materials Committee (D13) of the American Society for Testing Materials has issued a report (*Textile World*, 8th July, 1922) recommending the adoption of the following tentative methods for testing cotton fibres :—

“ 1. The strength shall be the strength of a group of fibres expressed in terms of a weight equal to a unit weight of 20s yarn.

(a) Preparation of sample.

“ 2. (a) The cotton shall be pulled down in the customary manner of a cotton classer which produces fibres that are essentially parallel.

“ (b) The fibres shorter than $\frac{7}{8}$ in. shall be removed by means of a small brush.

“ (c) The group or bundle of fibres shall be cut to equal $\frac{7}{8}$ in. to assure all fibres being $\frac{7}{8}$ in. long.

“ (d) The bundles shall be weighed, each bundle to weigh approximately 0.004 g.

“ (e) The ends of each group shall be cemented with collodion to prevent the fibres from slipping.

“ Five bundles shall be used.

(b) *Procedure.*

“ 3. The samples shall be exposed to a relative humidity of 70 per cent. for two hours before weighing and before testing for strength.

“ 4. The conventional inclination balance testing machine of 10-lb. capacity shall be used with the clamp moving at the rate of 12 in. per minute.

“ The distance between the clamps shall be $\frac{1}{2}$ in.

“ The clamps shall be flat, of the metal or rubber insert type, $\frac{1}{2}$ in. in width and $\frac{1}{2}$ in. in depth.

“ 5. The result shall be expressed in terms of an equivalent weight of 20s yarn by the formula :

$$\text{Strength in ounces of cotton equal to unit of 20s yarn} = \frac{\text{Sum of strengths in pounds} \times 16 \times 453.6 \times 7}{\text{Sum of weights in grams} \times 840 \times 20 \times 36 \times 8}$$

It will be observed that no detailed results are published and no information is given as to the consistency of measurements and probable errors to be expected. Obviously, as only 5 tests are advised, much will depend on the way in which samples are drawn, and the significance of the results is somewhat doubtful. It is clear that the procedure is by no means speedy and probably far more useful results, for the same expenditure of time, would be obtained by the use of single fibres in a “ Magazine ” tester as described by Balls. [B. C. BURT.]

THE FORMATION OF SUGAR AND THE RIPENING OF SUGARCANE.*

THIS publication consists of two parts, the first dealing with the physiology of sugar formation, the second containing a detailed discussion of the methods used in Java to harvest the cane fields at the exact moment of highest maturity. In the first part the author looks at the question of producing a cane crop from a physiological

* Suikervorming en ryping by het suikerriet, by Dr. J. Kuyper, *Archief voor de Suikerindustrie in Nederlandsch Indië*, 1922, 2e deel blz., 195-321, Mededeelingen No. 5 with 69 diagrams in text.

point of view ; it is emphasized that light energy is the most important factor in production of organic matter ; hence cultivation must be directed in such a way that as high a percentage as possible from this energy, which is a constant per unit of area, may be made useful for the plant. From this point he discusses the question of distance between the cane-rows and between the plants in each row, the influence of yellow stripe disease on sugar production—because in the attacked plants there is a shortage of chlorophyl whence the available light energy cannot be fully employed—, and the question of tying up the cane as a means of control against lodging. Binding the tops together is shown to be a method which may do sometimes even more damage to the crop than lodging, because the leaf surface is reduced in this way, and a certain amount of light energy is spoiled. The relation between cane production (cellulose) and sugar content is also discussed.

In the second part the method employed in Java to watch the course of the ripening process is described. Samples are taken on a fixed system in the fields ; these samples, containing on an average 20 canes, are cut into 3 parts, which are separately analysed. The samples are taken at regular time, with an interval of 14 to 20 days. The course of maturing can be judged by the relation between total solids and the quotient of purity in the different parts of the stalk ; it is also shown that the glucose ratio changes in a way which is just the contrary from what is seen in the percentage of available sugar. From these samples the influence of the different conditions of growth such as caused by soil and climate may be seen. It is proved that the month in which the cane is planted and the age of the cane has a considerable influence on the course of the process ; if climatic conditions are favourable the sugar content of these fields of different age may reach almost the same final percentage ; in unfavourable conditions the last planted cane will not reach the same sugar content. Differences exist between wet and dry climates and between several cane varieties, which are dealt with separately. Numerous graphs illustrate these chapters.

Cane ripens in the most regular way in those districts where there is either no rainfall or else a very small amount during the

milling season, and when the soil has a moisture content which is hardly sufficient to allow the cane to grow but just suffices to keep it from dying.

* * *

BRITISH MILKING RECORDS.

FIRST 3,000-GALLON COW.

FURTHER evidence of the remarkable improvement in British dairy cattle since the inception, by the Ministry of Agriculture, of the movement to record the milk yields of cows, is furnished by three recent record-breaking performances standing to the credit of the British Friesian breed.

At midday on Thursday, 26th October, 1922, the British Friesian cow, Brookside Colantha, completed her yield of 3,000 gallons of milk in less than 365 days. This cow, owned by the Hache Herd at Findon, Worthing, is the first cow in this country to reach a production of 3,000 gallons in less than a year. Sixty-two British cows have annual milk yields in excess of 2,000 gallons in one year, and of that number no less than 58 are British Friesians, the breed that has won every open milk championship for three years running at the Dairy Show. In her lifetime Brookside Colantha has had five calves and produced 9,530 gallons of milk, equivalent to about 42½ tons, and nearly sixty times her own weight.

FIRST 2,000-GALLON HEIFER.

ANOTHER record for Britain has been set up by the British Friesian heifer, Chaddesley Glen-Stately, the property of Longford Farms Ltd., Derby. This remarkable animal has yielded, since giving birth to her first calf, 2,004 gallons in 358 days, the extraordinary merit of her performance being that she is the first heifer in this country to attain the coveted 2,000-gallon production in her initial lactation period yield.

Another record-breaking feat is that accomplished by the Haydon herd of British Friesian cattle belonging to Mrs. Putnam. In this herd, during the last few days, three cows have reached the 2,000-gallon standard of production, namely, Beccles Lulu, Saltcote

Pel Daisy, and Gorstage Gem. Each month the British Friesian Cattle Society publishes, for the information of its members, a list of heavy milking cows with their yields to date, and Mrs. Putnam is the first breeder to have at one time three 2,000-gallon cows in such list. The above figures indicate the great improvements effected in the dairy cows of this country in general and in the British Friesian cattle in particular. [*North British Agriculturist*, dated 2nd November, 1922.]

* * *

AGRICULTURAL DEVELOPMENT IN THE CAMEROONS.

WE have received the following for publication from the Imperial Institute :—

The current number (Vol. XX, No. 2) of the " Bulletin of the Imperial Institute " contains an informative article dealing with recent developments in agriculture in that part of the former German Colony of the Cameroons which is now being administered under the mandate by Great Britain. The article, which is written by Mr. F. Evans, the Government Supervisor of Plantations in the Cameroons, is of particular interest in view of the sale of the ex-enemy estates in that province recently conducted in London by Messrs. Hampton and Sons.

The German authorities, up to 1914, conducted numerous experiments, both at the Government experiment stations and on private estates, with a view to improving the output and quality of the staple products, such as cocoa, rubber, palm oil and various food crops, whilst new crops which seemed likely to succeed in the country were introduced. Marked results were obtained with cocoa, the Cameroons product now being of good grade and taking a high place in the world's markets. This experimental work is being continued so far as the limited staff of the present Agricultural Department admits.

Under the German regime European occupation of land for planting purposes was encouraged and the Government undertook to supply and control all labour both for public works and private enterprise. This resulted in the rapid creation of a sound

agricultural industry and the development of large tracts of forest land. Since the British occupation a system of voluntary labour has been initiated and has proved satisfactory, whilst for future development Mr. Evans considers there should be no difficulty in obtaining labour at reasonable rates from the thickly populated districts of the adjoining protectorate of Nigeria. He points out that the soil in the Cameroons is very fertile, the rainfall is well distributed, whilst transport and shipping facilities are good. In addition to the crops now cultivated there are large tracts suitable for tobacco, sugar, bananas, and coconuts, and tea should thrive in the hills. The conditions of life generally are unrivalled in West Africa, and the country offers excellent opportunities to men of initiative, who have sufficient capital to engage in tropical agriculture.

APPARATUS FOR STAPLE DIAGRAMS.

TARDY recognition that absolute facts are essential to the completely efficient production of yarns and fabrics is apparent. Recently we have inaugurated magnificent research laboratories to supply the cotton industry with information based on careful scientific investigation. Who knows what changes may take place as a result of the findings during future years. Even in the mills there is a growing tendency to set fact based on investigation against rule of thumb which has prevailed too long. The results, although not revolutionary in one sense, have secured economies and quality that has amply repaid the almost insignificant outlay occasioned. We recently drew attention to Dr. Lawrence Balls' sledge apparatus for ascertaining the staple conditions of a sample of cotton.¹ The usual indications as to lengths of staple are insufficient for technical purposes. This is due to the fact that only the approximate commercial staple is ascertained, and no exact indication is given in regard to the proportion of short fibres contained in the bulk supply. Exact knowledge is essential, particularly if it is desired to adopt a high draft system. The

¹ *Textile Recorder*, 459, p. 81.

need is felt, therefore, for some more definite knowledge, and a staple diagram becomes a necessity. For example, by spreading out according to their lengths—on a dark surface—all the fibres contained in a sample of trial cotton a diagram is obtained which clearly indicates the distribution of long, medium and short fibres, and consequently gives a very definite indication as to the value of the cotton. By a simple calculation of its surface the average real length of the fibre is obtained. By producing to the top of the diagram the space measurements between the two anterior pairs of drawing rollers, the proportion of floating fibres in the drawing space is clearly shown. This is illustrated in the accompanying figure.

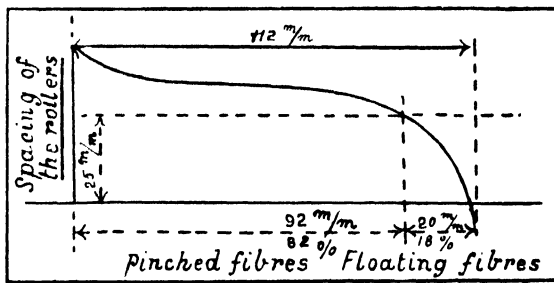

In this way it is possible to secure the most advantageous setting of the drawing rollers for any given cotton, and further, to determine the weight of the pressure roller for the second pair. It will thus be agreed that two essential points for a high draft are obtained.

Messrs. Henry Baer & Co., of Zurich, whose agents in this country are W. Isherwood & Co., 32, Albert Street, Manchester, have recently introduced an apparatus simple in itself, and after a little practice easily used to produce a staple diagram. The apparatus consists of a series of combs, upper and lower. The lower combs are suitably carried so that they can be lowered at one end, or both, as desired. The teeth of the upper combs project towards those of the lower set when in position. They are supported in slots, and are readily removable individually. The piece of material to be tested is stretched and doubled several times, and

then slightly twisted. If the cotton is dry it should be slightly moistened—this being most easily and readily done by breathing on it. The strip of material is placed in the lower combs at the left of the apparatus, and worked down into the teeth by means of the small wooden rake. The points sticking out behind the apparatus should have a length of about 1 mm. Various operations for equalizing the fibres, straightening, removing impurities, etc., can be performed, the object being to get them into a proper position for securing the diagram. The nature and number of such operations will, of course, depend upon the material and the degree of skill of the operator. The upper combs are placed in position, and the tweezers used to draw fibres through the combs. Those which overlap the outer comb are, of course, only drawn, and they are placed on a black velvet-covered plate, the end on base being laid exactly on a chalk line already drawn on the plate. The operation is repeated, the longest fibres only being drawn. A needle is supplied to straighten the fibres if necessary.

When no further fibres can be taken from in front of comb No. 1, it is dropped and the operation continued. The process goes on until finally all the fibres remaining in the last comb are taken up and placed at the end of the diagram.

When this has been done the glass scale plate is placed over the fibres, and the surface can be calculated or put on scaled ruled paper without danger of disturbing the arrangement. The apparatus is certainly ingenious, and, as demonstrated to the writer, effective. [*Textile Recorder*, XL, 470.]

* * *

COTTON RESEARCH

THROUGH the courtesy of the British Cotton Industry Research Association, the Secretary of the Indian Central Cotton Committee has sent the following abstracts for publication :—

TESTING OF COTTON HAIR.

THE “fineness” of a sample of raw cotton is measured by carefully weighing 100, 200 or more hairs, stretching them out by

means of glycerol on a glass plate lying on black velvet or cloth so as to measure the total length, and dividing this length by the weight. The "fineness" is thus recorded in metres per gram. [*Mededeel. Rijksvoorlichtingsdienst, Vezel., Delft, 1922, p. 19. W. FRENZEL.*]

TESTING OF YARN.

The "fineness" of the fibres in a yarn is determined as follows:—

(1) The weight of 1 metre of the yarn is measured at 65 per cent. humidity, the yarn being held taut by a load equivalent to 100 metres of the same yarn; (2) Portions $1\frac{1}{2}$ –2 millimetres long are now cut at 10 equally-spaced points along the metre length of yarn, and the separate fragments in each group are laid out in tens and so counted, the average of the 10 groups giving the number of fibres in the cross section; (3) This number, n , multiplied by the metric number of the yarn gives the mean "fineness" of the fibres in metres per gram. A large number of yarns has been examined by this method. The "fineness" ranged from 4,100–5,000 metres per gram for mule yarns of English counts 16's–114's, or 3,540–5,000 for 23's–78's ring yarns. The metric counts of the yarn are found to be inversely proportional to the number of fibres per cross section, the relationship being constant for a given kind of cotton and reproducible by a parabolic curve. It is possible therefore to estimate the number of fibres in the cross section of one yarn of known count if the number and count are known for another yarn of the same cotton. For example, if a yarn of metric counts 100 (English 60's) has 50 fibres per cross section, a yarn of 5's would have 1,000. As a practical application of such a rule, the following is mentioned:—

Suppose a lap of 410 grains per yard is to be combed for the production of 100's yarn with 25 fibres per cross section. Calculation shows that the lap would have 122,550 fibres per cross section. If the comb has 50,000 teeth it follows that the fibres will not be treated singly but in groups of 2 or 3. [*Mededeel. Rijksvoorlichtingsdienst, Vezel, Delft, 1922, pp. 18–20. W. FRENZEL.*]

**PERSONAL NOTES, APPOINTMENTS AND TRANSFERS,
MEETINGS AND CONFERENCES, ETC.**

THE HON'BLE RAO BAHADUR B. N. SARMA, Member in charge of the Revenue and Agriculture Department, Government of India, visited the Agricultural Research Institute at Pusa from the 11th to 16th December, 1922.

* * *

THE services of Mr. J. W. HEARN, B.A., LL.B., I.C.S., Under-Secretary to the Government of India, Revenue and Agriculture Department, are placed at the disposal of the Government of the Punjab from the 25th January, 1923.

* * *

MR. G. S. HENDERSON, N.D.A., N.D.D., Imperial Agriculturist, was on privilege leave for 15 days from the 7th October, 1922, Khan Sahib Mohamad Ikramuddin officiating.

* * *

MR. R. S. FINLOW, B.Sc., Fibre Expert to the Government of Bengal, has been appointed to act as Director of Agriculture, Bengal, during the absence, on leave, of Mr. G. Evans, C.I.E., or until further orders.

* * *

MR. F. SMITH, B.Sc., Deputy Director of Agriculture, Eastern Circle, Bengal, has been granted combined leave for 15 months from or after the 25th November, 1922.

* * *

MR. K. T. ALWA has been appointed to act as Deputy Director of Agriculture, II Circle, Madras, from the 19th December, 1922.

* * *

MR. D. MILNE, B.Sc., Principal, Agricultural College, Lyallpur, has been appointed to officiate as Director of Agriculture, Punjab,

relieving Mr. S. M. Jacob, I.C.S. Mr. Milne has also been nominated a Member of the Local Legislative Council.

* * *

ON return from leave, SARDAR DARSHAN SINGH, M.R.A.C., Deputy Director of Agriculture, Punjab, resumed charge of the Hansi Circle on the 6th September, 1922.

* * *

KHAN SAHIB MAULVI FATEH-UD-DIN, Deputy Director of Agriculture, has been temporarily attached to the office of Director of Agriculture, Punjab, as Personal Assistant.

* * *

MR. M. AFZAL HUSAIN, M.A., has been confirmed as Entomologist to Government, Punjab, from the 30th September, 1920, and in the Indian Agricultural Service from the 6th January, 1922.

* * *

MR. U. W. F. WALKER, M.R.C.V.S., Professor of Surgery, Punjab Veterinary College, Lahore, has been appointed Professor of Hygiene, in addition to his own duties, from the 2nd October, 1922, *vice* Mr. K. J. S. Dowland resigned.

* * *

MR. J. W. GRANT has been appointed to the Indian Agricultural Service and posted to Burma as a Deputy Director of Agriculture with headquarters at Mandalay.

* * *

MR. F. D. ODELL has been appointed to the Indian Agricultural Service and posted to Burma as a Deputy Director of Agriculture with headquarters at Thayetmyo.

* * *

MR. W. SMITH-ROLLO, A.M.I.E. (Ind.), has been appointed Agricultural Engineer, Burma, for a period of one year and posted to duty with headquarters at Mandalay.

THE services of CAPTAIN J. B. IDLE, Fourth Superintendent, Civil Veterinary Department, and Superintendent, Stock-Breeding, Burma, have been placed at the disposal of the Director of Agriculture, Burma, to whom the general supervision of experiments on stock-breeding has been entrusted.

* * *

MR. E. A. H. CHURCHILL, B.Sc., Assistant Director of Agriculture, Central Provinces, has been granted leave on half average pay for six months on medical certificate, in extension of leave granted to him.

* * *

MR. S. M. PAGAR has been appointed on the Central Cotton Committee as the representative of the Baroda State, *vice* Mr. M. B. Nanavati.

* * *

THE Fifth Entomological Meeting will be held at Pusa on Monday, the 5th February, 1923, and following days.

Reviews

The Coccidæ of Ceylon.—By E. ERNEST GREEN. Part V, with 74 Plates. (London: Dulau & Co.; 1922.) Price £10 for the complete work.

THE appearance of the concluding part of a book, which has already become a classic even before its completion, is a noteworthy event. Part I was published as long ago as 1896 and the completed volume represents, not only a worthy and welcome contribution to entomological literature, but a life's labour of love for his subject by Mr. Green, who is at once author and artist.

The Coccidæ or Scale-insects of the Indian Region, of which Ceylon of course forms a part, were practically unknown when Mr. Green commenced to take an interest in them during his residence in Ceylon, where he did so much to create an interest in entomology during his term of office as Government Entomologist at Peradeniya. Yet the Scale-insects, whether as pests of cultivated plants and especially of fruit-trees or as commercially important animals (such as the lac-insects), are amongst the most important groups of insects from an economic point of view. Thanks to Mr. Green's unsparing efforts the species which occur in Ceylon are now relatively well known and many of these of course occur in India and Burma also, so that the present work forms a foundation for the study of the Coccidæ of the whole Indian Region.

We can find nothing but admiration for this book, for the clearly-written descriptions, for the exquisite coloured plates and for the unflagging zeal and hard work which have gone to produce it. We can only recommend to our entomological brethren the old saying, "Go thou and do likewise," and to all our readers in any way interested in Scale-insects to procure a copy for themselves whilst it is still in print. [T. B. F.]

The Feeding of Dairy Cattle.—By ANDREW C. McCANDLISH, M.S.A. Pp. xx+282; 15 figs. (New York: John Wiley & Sons, Inc.; London: Chapman and Hall, Ltd.) Price, 12s. 6d.

THE book divides itself broadly into three equal sections dealing respectively with the principles of nutrition, with a description of feeding stuffs and with feeding practice.

The scope of the section on nutrition has been to give a sketch of, rather than an introduction to, the science. The author has succeeded in presenting a clear review of the subject which should prove valuable to all students of dairy farming who wish to become acquainted with the principles of nutrition.

The seven chapters comprising 68 pages which are devoted to a brief description of feeding stuffs appear to be somewhat redundant, though possibly they are inserted to meet a definite need in America.

The later chapters are concerned with feeding practice, and contain careful records of practical experience in the feeding and care of cattle.

The book gives a well balanced and comprehensive survey of the subject of feeding dairy cattle and should be useful to students of dairy farming.

The short appendix containing tables, which show the composition, digestibility and monetary values of some typical American feeding stuffs, cannot be passed over without remark.

Those who are concerned with cattle feeding in India can only look at these and similar tables in other American publications with a feeling of envy. A vast amount of work remains to be done in this country to procure similar information relating to Indian foodstuffs. [F. J. W.]

* * *

The International Cotton Bulletin.—As a result of the decision reached at the last Cotton Congress held by the International Federation of Master Cotton Spinners and Manufacturers Association at Stockholm, the Federation now issues a quarterly periodical under the above title which includes, in addition to the half-yearly international cotton statistics, notes on cotton growing and cotton

industry from all parts of the world. While some of the latter are extracts from textile papers and Government reports, others are taken from consular reports and other sources not always easily available. Much information is brought together in a convenient form, particularly in regard to progress in the newer cotton-growing countries. [B. C. B.]

* * *

The Journal of the Textile Institute.—Extracts from this journal have appeared in the “Agricultural Journal of India” on several occasions, but it is not perhaps generally known that it is now the official journal for communications leased for publications by the following Research Associations under the Department of Industrial and Scientific Research :—The British Cotton Industry Research Association, British Research Association for the Woollen and Worsted Industries, Linen Industry Research Association and the British Silk Research Association. A number of interesting papers have already appeared in the transactions dealing with the study of fibres as raw materials for manufacture. The preceding sections enclose a number of interesting notes on the cotton trade and cotton growing and the abstract section gives some current literature pertaining to textile industries, including a very useful sub-section on fibres and their production. Membership of the Institute is open to all persons interested in promoting the welfare of the textile industries and occupying responsible positions in connection with any of its branches including production or handling of raw materials. This journal should find a place in all agricultural libraries. [B. C. B.]

NEW BOOKS

ON AGRICULTURE AND ALLIED SUBJECTS

1. More Beetles, by J. H. Fabre. Translated by A. Teixeira de Mattos. Pp. viii + 278. (London : Hodder and Stoughton.) Price, 8s. 6*d.* net.
2. The Life of the Weevil, by J. H. Fabre. Translated by A. Teixeira de Mattos. Pp. viii + 278. (London : Hodder and Stoughton.) Price, 8s. 6*d.* net.
3. An Introduction to the Chemistry of Plant Products. Vol. 2 : Metabolic Processes, by P. Haas and T. G. Hill. Pp. viii + 140. (London : Longmans, Green & Co.) Price, 7s. 6*d.*
4. Tsetse-flies : Their Characteristics, Distribution and Bionomics, with some account of Possible Methods of Control, by Major E. E. Austin and E. Heigh. Pp. ix + 188 ; 5 plates. (London : Imperial Bureau of Entomology.) Price, 7s. 6*d.* net.
5. Efficient Marketing for Agriculture : Its Services, Methods and Agencies, by T. Macklin. Pp. xviii + 418. (London : Macmillan & Co.) Price, 12s. 6*d.* net.
6. Note-book of Agricultural Facts and Figures for Farmers and Farm Students, by P. McConnell. Tenth Edition, revised and enlarged. Pp. 547. (London : C. Lockwood & Son.) Price, 15s. net.
7. An Indexed System of Veterinary Treatment : Modern Medical, Surgical, and Biological Therapy, by W. Scott with the collaboration of various writers. Pp. 647. (London : Baillière Tindall & Cox.) Price, 31s. 6*d.* net.
8. Agricultural Bacteriology, by J. E. Greaves. Pp. 437. (London, Bombay and Sydney : Constable & Co.) Price, 21s. net.
9. The Marketing of Whole Milk, by Dr. H. E. Erdman. Pp. xvi + 333. (London : Macmillan & Co.) Price, 21s. net.

THE following publications have been issued by the Imperial Department of Agriculture in India since our last issue:—

Memoirs.

1. Investigations on Indian Opium, No. 3. Studies in the Meconic Acid Content of Indian Opium, by Harold E. Annett, D.Sc. (Lond.), F.I.C., M.S.E.A.C., and Mathura Nath Bose, M.A. (Chemical Series, Vol. VI, No. 6.) Price, As. 6 or 6d.
2. Notes on Indian Diptera, by Ronald Senior-White, F.E.S. (Entomological Series, Vol. VII, No. 9.) Price, R. 1-12 or 2s. 3d.
3. Etiology of Equine Contagious Abortion in India, by T. M. Doyle, F.R.C.V.S. (Veterinary Series, Vol. III, No. 5.) Price, As. 8 or 9d.

Bulletins.

4. An Entomologist's Crop Pest Calendar for the Madras Presidency, by T. V. Ramakrishna Ayyar, B.A., F.E.S., F.Z.S. (Bulletin No. 131.) Price, As. 2.
5. Results of Investigation of Bionomics of *Platyedra gossypiella*, Saund. in South India, together with some notes on *Earias insulana* and *E. fabia*, by E. Ballard, B.A., F.E.S. (Bulletin No. 133.) Price, As. 5.
6. Supplementary Observations on Borers in Sugarcane, Rice, etc., by C. C. Ghosh, B.A. (Bulletin No. 134.) Price, As. 6.
7. The Hydrogen Ion Concentrations of some Indian Soils and Plant Juices, by W. R. G. Atkins, O.B.E., Sc.D., F.I.C. (Bulletin No. 136.) Price, As. 4.
8. List of Publications on Indian Entomology, 1920-21, compiled by the Imperial Entomologist. (Bulletin No. 139.) Price, R. 1.

Indigo Publication.

9. The Nature of changes occurring in the Indigo Steeping Vat, by W. A. Davis, B.Sc., A.C.G.I. (Indigo Publication No. 11.) Price, R. 1-10.

Reports.

10. Scientific Reports of the Agricultural Research Institute and College, Pusa (including the Reports of the Imperial Dairy Expert and the Secretary, Sugar Bureau), for the year 1921-22. Price, As. 14.
11. Annual Report of the Imperial Bacteriological Laboratory, Muktesar, for the year ending 31st March, 1922. Price, As. 9.
12. Report on the Diseases of Silkworms in India, by A. Pringle Jameson, D.Sc. Price, Rs. 3.

PUBLICATIONS ON INDIAN AGRICULTURE AT CONCESSION RATES

**For Students & Ex-Students of Agricultural Colleges
and
Subordinate Officers of Agricultural Departments**

The Agricultural Journal of India. Up to Vol. XI. Vols. III, IV, X, and XI are complete ; odd copies of other volumes also available Rs. 3 per Vol.
Scientific Memoirs. <i>All series</i> Half price.
Bulletins and Indigo Publications Two-thirds price.
Scientific Reports of the Pusa Institute, 1905-06—1918-19 Half price.
Report on the Progress of Agriculture in India, 1907-09, 1909-10, 1911-12— 1918-19 Half price.
Proceedings of the Board of Agricul- ture Half price.
Reports on Introduction of Improve- ments in Indian Agriculture Half price.

Postage Extra.

Apply to—

**Director, Agricultural Research Institute,
PUSA (Bihar)**

VOL. XVIII, PART II

March, 1923

THE AGRICULTURAL JOURNAL OF INDIA



EDITED BY

The Agricultural Adviser to the Government of India

PUBLISHED FOR

THE IMPERIAL DEPARTMENT OF AGRICULTURE IN INDIA

BY

THACKER, SPINK & CO., CALCUTTA

W. THACKER & CO., 2, CREED LANE, LONDON

Price R. 1-8 or Two Shillings

Agents for the Sale of Government Publications

IN EUROPE

- Constable & Co., 10, Orange Street, Leicester Square, London, W.C.
Kegan Paul, Trench Trübner & Co., 68-74, Carter Lane, E.C., and 25, Museum Street, London, W.C.
Bernard Quaritch, 11, Grafton Street, New Bond Street, London, W.
P. S. King & Sons, 2 & 4, Great Smith Street, Westminster, London, S.W.
H. S. King & Co., 65, Cornhill, E.C., and 9, Pall Mall, London, W.
Grindlay & Co., 54, Parliament Street, London, S.W.
Luzac & Co., 46, Great Russell Street, London, W.C.
W. Thacker & Co., 2, Creed Lane, London, E.C.
T. Fisher Unwin, Limited, 1, Adelphi Terrace, London, W.C.
B. H. Blackwell, 50 & 51, Broad Street, Oxford.
Deighton, Bell & Co., Ltd., Cambridge.
Oliver & Boyd, Tweeddale Court, Edinburgh.
E. Ponsonby, Ltd., 116, Grafton Street, Dublin.
Ernest Leroux, 28, Rue Bonaparte, Paris.
Martinus Nijhoff, The Hague, Holland.
Otto Harrassowitz, Leipzig.
Friedlander and Sohn, Berlin.

IN INDIA AND CEYLON

- Thacker, Spink & Co., Calcutta and Simla.
W. Newman & Co., Calcutta.
R. Cambray & Co., Calcutta.
S. K. Lahiri & Co., Calcutta.
B. Bannerjee & Co., Calcutta.
The Indian School Supply Depôt, 309, Bow Bazar Street, Calcutta, and 226, Nawabpur, Dacca.
Butterworth & Co. (India), Ltd., Calcutta.
Rai M. C. Sarkar Bahadur & Sons, 75-1-1, Harrison Road, Calcutta.
The Weldon Library, 57, Park Street, Calcutta.
Standard Literature Co., Ltd., Calcutta.
Lal Chand & Sons, Calcutta.
Higginbothams, Ltd., Madras.
V. Kaliyanarama Iyer & Co., Madras.
G. A. Natesan & Co., Madras.
S. Murthy & Co., Madras.
Thompson & Co., Madras.
Temple & Co., Madras.
P. R. Rama Iyer & Co., Madras.
E. M. Gopalakrishna Kone, Madras.
Thacker & Co., Ltd., Bombay.
A. J. Combridge & Co., Bombay.
D. B. Taraporevala, Sons & Co., Bombay.
Mrs. Radhabai Atmaram Sagoon, Bombay.
Sunder Pandurang, Bombay.
Gopal Narayan & Co., Bombay.
Ramchandra Govind & Son, Kalbadevi, Bombay.
A. H. Wheeler & Co., Allahabad, Calcutta and Bombay.
N. B. Mathur, Superintendent, Nazir Kanun-i-Hind Press, Allahabad.
Rai Sahib M. Gulab Singh & Sons, Mufid-i-Am Press, Lahore.
A. Chand & Co., Lahore, Punjab.
Ram Krishna & Sons, Lahore.
Superintendent, American Baptist Mission Press, Rangoon.
Manager, the "Hitavada," Nagpur.
S. C. Talukdar, Proprietor, Students & Co., Cooch Behar.
A. M. & J. Ferguson, Colombo, Ceylon.
Manager, Educational Book Depôts, Nagpur and Jubbulpore.*
Manager of the Imperial Book Depôt, 63, Chandney Chauk Street, Delhi.*
Manager, "The Agra Medical Hall and Co-operative Association, Ltd." (Successors to A. John & Co., Agra.)*
Superintendent, Basel Mission Book and Tract Depository, Mangalore.*
P. Varadachary & Co., Madras.*
H. Liddell, Printer, etc., 7, South Road, Allahabad.*
D. C. Anand & Sons, Peshawar.*
Ram Dayal Agarwala, 184, Katra, Allahabad.*
Manager, Newal Kishore Press, Lucknow.*

* Agents for the sale of Legislative Department Publications only.

CONTENTS

(VOL. XVIII, PART II)

ORIGINAL ARTICLES

PAGE

- SOME COMMON INDIAN BIRDS. NO. 20. THE
BENGAL JUNGLE-BABBLER OR "SEVEN
SISTERS" (*Turdoides terricolor terricolor*) .. T. Bainbrigg
Fletcher, R.N.,
F.L.S., F.E.S.,
F.Z.S.; and C. M.
Inglis, M.B.O.U.,
F.E.S., F.Z.S. 99
- EXPERIMENTS ON THE GREEN-MANURING OF
RICE C. Somers Taylor;
and Manmathanath
Ghosh 104
- SOME ASPECTS OF AGRICULTURAL MARKETING
AS ILLUSTRATED BY THE LYALLPUR CO-
OPERATIVE COMMISSION SALE SHOPS .. H. K. Trevaskis,
O.B.E., I.C.S. 115
- A PRELIMINARY ACCOUNT OF SYMBIOTIC NITRO-
GEN FIXATION IN NON-LEGUMINOUS PLANTS
WITH SPECIAL REFERENCE TO *Chomelia asia-
tica* K. Adinarayan Rao,
L.Ag. 132
- A USEFUL PLANT FOR INDIA (*Pteropis juliflora*) K. Kumbhikannan,
M.A., Ph.D.,
F.E.S. 144
- A PRELIMINARY NOTE ON THE THEORY OF
PHOSPHATIC DEPLETION IN THE SOILS OF
BIHAR Albert Howard,
C.I.E., M.A.; and
Gabrielle L. C.
Howard, M.A. 148

SELECTED ARTICLES

	PAGE
PROOF OF THE POWER OF THE WHEAT PLANT TO FIX ATMOSPHERIC NITROGEN	155
NITROGEN FIXATION IN ARID CLIMATES	158
ELECTRO-CULTURE	167
THE WORLD'S WHEAT POSITION	173

NOTES

MECHANICAL TILLAGE OF THE SOIL FOR SUGARCANE IN JAVA ..	176
STATISTICAL RECORD OF THE DISTRIBUTION OF THE CANE VARIETIES IN JAVA FOR THE CROP 1921-22	177
DISTRIBUTION OF LIVING PLANTS BY POST	178
CO-OPERATIVE COTTON MARKETING	180
RESTRICTIONS ON IMPORT OF POTATOES	182
AGRICULTURAL DEVELOPMENTS IN THE GOLD COAST	182
RHINOCEROS BEETLE	183
SUGAR PRODUCTION FROM TROPICAL PALMS (<i>Nipa palm</i>)	184
IDENTIFICATION OF DAIRY COWS BY NOSE-PRINT	185
COTTON SPINNING IN CHINA	187
COTTON RESEARCH	188

PERSONAL NOTES, APPOINTMENTS AND TRANSFERS, MEETINGS AND CONFERENCES, ETC.	190
---	------------

REVIEWS

AGRICULTURAL PROGRESS IN WESTERN INDIA	193
THE FERNS OF BOMBAY	194

NEW BOOKS ON AGRICULTURE AND ALLIED SUBJECTS	196
---	------------

LIST OF ILLUSTRATIONS.

The Bengal Jungle-Babbler or "Seven Sisters" (<i>Turdoides terricolor</i> <i>terricolor</i>)	Frontispiece
	Facing page
Plate II. Green-manuring of rice, 1920	107
„ III. The continuous growth of Java indigo in the same soil at Pusa	150

***The following Original Articles will appear in our next issue
(May 1923).***

- SOME COMMON INDIAN BIRDS. No. 21. THE
COMMON MYNAH *T. Bainbrigge Fletcher,*
R.N., F.L.S., F.E.S.,
F.Z.S. ; and C. M. Inglis,
M.B.O.U., F.E.S., F.Z.S.
- THE RÔLE OF PLANT PHYSIOLOGY IN AGRICUL-
TURE *Gabrielle L. C. Howard,*
M.A.
- TECHNOLOGICAL RESEARCH ON RAW MATERIALS
AND ITS RELATION TO PLANT BREEDING .. *B. C. Burt, M.B.E., B.Sc.*
- UNAVOIDABLE ERROR OF FIELD EXPERIMENTS .. *O. T. Faulkner, B.A.*

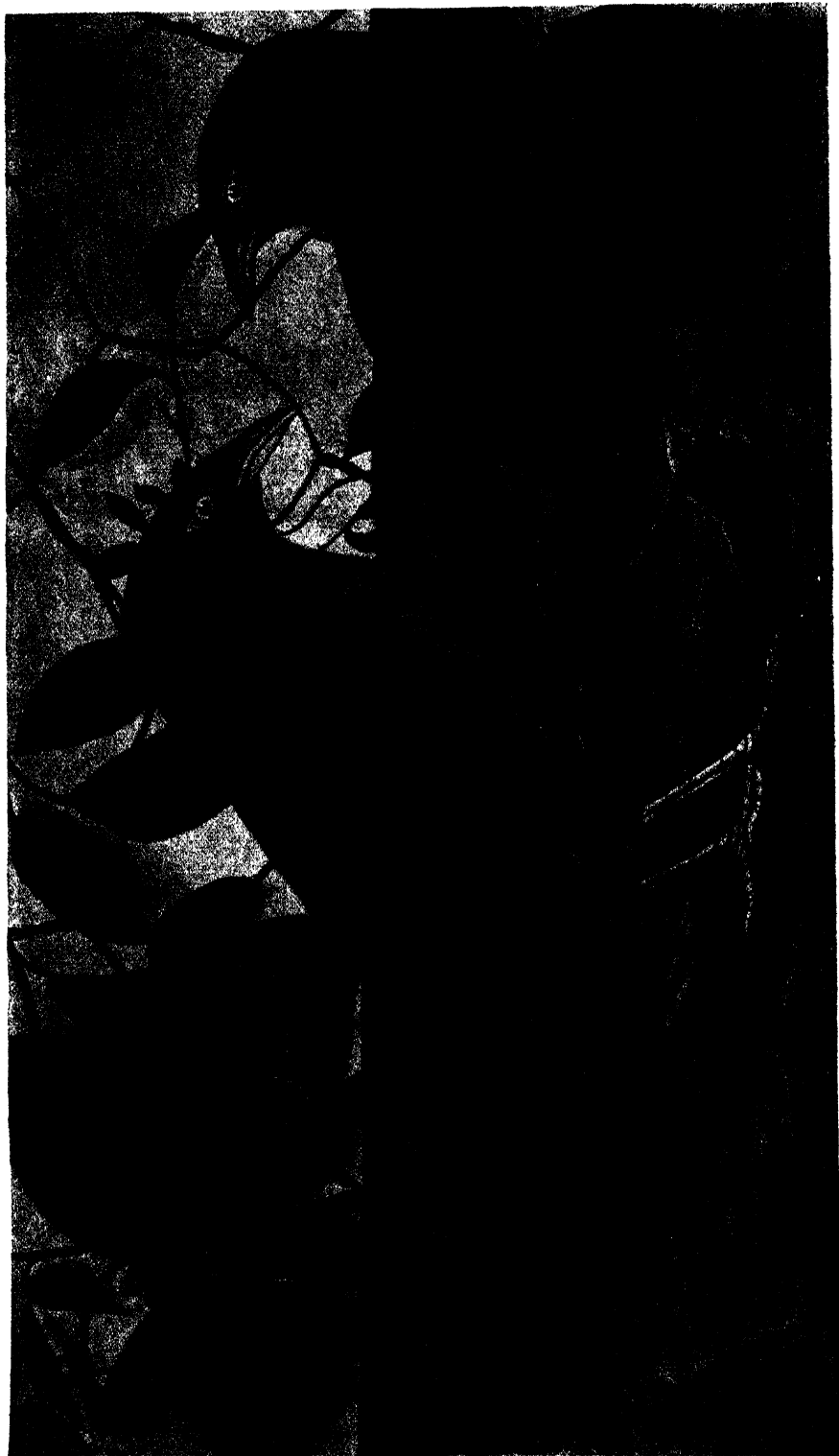

THE BENGAL JUNGLE BABBLER OR SEVEN SISTERS
(*TURDOIDES TERRICOLOR TERRICOLOR*).

Original Articles

SOME COMMON INDIAN BIRDS.

No. 20. THE BENGAL JUNGLE-BABBLER OR "SEVEN SISTERS"
(*TURDOIDES TERRICOLOR TERRICOLOR*).

. BY

T. BAINBRIGGE FLETCHER, R.N., F.L.S., F.E.S., F.Z.S.,
Imperial Entomologist ;

AND

C. M. INGLIS, M.B.O.U., F.E.S., F.Z.S.

THE subject of our present article rejoices in several names. In the new edition of the *Fauna* volume on Birds it is called the Bengal Jungle-Babbler (*Turdoides terricolor terricolor*) whereas it was referred to in the former edition as the Jungle-Babbler (*Crateropus canorus*), and it is also known as the Bengal Babbler, the Seven Sisters, *Chatarhia* (in Bengal), *Pengya-maina* (in the United Provinces), *Kutch-batchia* (in Bihar), *Pedda-Sida* (in Telugu) and as *Sat Bhai*, *Jangli-Khyr* and *Ghonghai* in Hindustani-speaking areas. Of these names, the popular names, "Seven Sisters" or *Sat Bhai*, and the scientific name, *Crateropus canorus*, are the best known applied to this bird, which is sufficiently common everywhere to be a familiar object in all shrubberies of compounds in Northern India north of a line drawn roughly from Orissa to Bombay. As its specific name implies, it is an earthy-coloured bird, a very little larger than a mynah with a long tail and a generally untidy look about it, which goes about in small flocks in shrubby places, hopping along over the ground and turning over dead leaves in search of food. In Southern India it is represented by the

Southern Jungle-Babbler (*Turdoides terricolor malabaricus*) which differs from the northern bird in being much darker both above and below, most noticeably so on the chin, throat, breast and flanks. The feathers are also darker edged, which shows up more vividly the central pale streaks on the shaft of the feather, these streaks being indistinct in the northern race. In North-Western India there is a third race, the Sind Jungle-Babbler (*T. terricolor sindianus*), which is paler than the Bengal race, with the upper parts greyer and with the shaft-streaks on the feathers ill-defined or obsolete. The general appearance and habits of all the three races, however, are pretty much the same and the following remarks may be taken to apply to all of them although our Plate represents the Bengal race.

The "Seven Sisters" is especially fond of gardens, being found wherever cover in the shape of a shrubbery is provided. In such places an observer will soon come across a small party of rather bedraggled-looking dusty-brown birds, rustling about in long hops amongst the dead leaves and keeping up a ceaseless gabble of conversation as they follow one another about, turning over the fallen leaves and twigs and peering and prying beneath them for insects, snails and worms. Whilst busy among the leaves they always seem to have an air of dread of finding something terrifying concealed under them and are constantly leaping into the air and starting backward, and yet all the time seem to be in the height of spirits. Although the flock often consists of about half-a-dozen individuals, the number is not necessarily seven and may at times exceed twenty, and why they should be known particularly as the *Seven Sisters* is not especially obvious. Seven is of course a sacred number since Babylonian times, signifying especially the seven planets (the five planets then known together with the sun and moon), whence the number of days in our modern week, and the number as applied to these little parties of birds possibly signifies completeness. Be this as it may, the number is not always seven, as Sir Edwin Arnold observed when referring to this bird in his *Light of Asia* :-

"The nine brown sisters chattered in the thorn."

As regards the second part of the name, as Stuart Baker well puts it, "their sisterhood or brotherhood they show by the manner in which each individual resents any interference from outside to any of the party yet retains full liberty to argue, disagree and fight with any one or all of the other six." In cases where one member of the party has been seized by a trained hawk, the others have been known to rush to its assistance and even to rescue it from the hawk. The bond of union resulting from their social habits seems so strong that on the escape from the cage of one individual of a party kept in captivity it has been known to do its best to get in again without further thought of escape. With regard to this trait Finn remarks that "it may be ungenerously suggested that such birds are afraid to go about alone, lest the ribald remarks, made in the security of numbers, meet with a just retaliation at the beaks and claws of outraged bird society; and so it may be, but nevertheless there is a well-spring of sincere sociability under the Babbler's frowsy feathering. On the comparatively rare occasions when my captives were still, they employed themselves in affectionately tickling each other's heads as they cuddled together, and I have even seen one diligently employed in endeavouring to clean the wing of a friend, soiled by the bird lime with which its capture had been effected. At the same time it must be admitted that the addition to their ordinary diet of table scraps of such a delicacy as a cockroach was apt to produce a sad disruption of fraternal harmony. On such occasions one might see one brother prone in the sand, while another, holding his head 'in chancery' with one foot, was punching the same with his beak in a manner calculated to awake grave fears for the integrity of the sufferer's skull when the punishment should be over; and once I saw two birds adherent with bill and claw to one and the same cockroach, which a third was devouring, as neither of the joint owners dared let go his hold."

The development of such a degree of clannishness in this bird is doubtless connected with its extremely weak flight. It seems to take to wing comparatively rarely, and when it does, a certain degree of momentum is attained by a violent beating of the wings for a short distance, after which the flight becomes a gliding skim,

their pace flagging and their line of flight sinking rapidly. Should a fairly wide open expanse need to be crossed, this can only be done by climbing a tree on one side high enough to allow for the rapid descent that attends their flight, much in the manner of a flying squirrel, which runs up a tree and casts itself off into the air, volplaning downwards on to another tree at a lower level and then running up that and repeating the performance. When in trees, these birds run along the branches in single file, often hopping over one another as they go, and run up and down the tree-trunks, clinging to the bark with great agility even when the surface is nearly vertical. The prehensile power of their feet is not only of use when climbing but also of assistance in holding food.

The "Seven Sisters," as would be expected from its terrestrial habits, is rather a mixed feeder, subsisting largely on insects, small lizards, frogs, worms, etc., which it finds amongst and under dead leaves and also on wild fruits which always seem to be picked up off the ground.

The late Mr. C. W. Mason examined the stomachs of thirty-six birds at Pusa and found the contents to consist largely of fig and *ber* fruits mixed with a great variety of insects and weed seeds, with an occasional frog, spider or centipede. The food is obtained in jungly or shrubby places and cultivated areas or crops seem to be rarely visited and this only when there are large trees or jungle close by. The nestlings are fed principally on caterpillars, with a few beetles and an occasional cricket or grasshopper. From an economic point of view, therefore, this bird may be regarded as beneficial to the farmer.

The generally untidy appearance of this bird seems to extend to its nesting habits, the nest being a loose untidy cup, often composed of aerial roots of fig-trees, and placed about twenty feet above the ground in the boughs of small trees or shrubs. At times, the nest may be placed much lower down. The structure of the nest is often so loosely woven that, when the bird is not sitting, the sky can be seen through it from below. The nesting season is any time between March and September but mostly either just before or just after the break of the South-West Monsoon. The usual

number of eggs is four, but as many as seven may be laid, and the egg is of a beautiful blue, intensely glossy, and measures about 25 to 20 millimetres. The Babbler is extensively parasitized by that extremely obnoxious bird the Hawk-Cuckoo or Brain-Fever Bird (*Hierococcyx varius*) whose eggs are very similar in general appearance, but usually less glossy and more elliptical in shape. It is also parasitized by the Pied-crested Cuckoo (*Clamator jacobinus*), just as often as by the Brain-Fever Bird, this Cuckoo also laying an egg very similar in colour to that of the "Seven Sisters". In one nest Mr. Inglis found no less than six eggs of the pied-crested Cuckoo, along with three eggs of the Babbler, evidently the produce of several individuals of the former species.

The Jungle-Babbler is protected by law throughout the year in Delhi, the United Provinces, Bengal and Assam, and in Madras in the Shevaroy Hills from February to June only.

EXPERIMENTS ON THE GREEN-MANURING OF RICE.

BY

C. SOMERS TAYLOR,

Agricultural Chemist to the Government of Bihar and Orissa ;

AND

MANMATHANATH GHOSH,

Assistant Professor of Chemistry and Physics, Sabour Agricultural College.

THESE experiments owe their inception to some observations made on soils in the south of Bhagalpur, which showed that these soils were deficient in phosphoric acid. In consequence, a series of experiments were made by one of us at Sabour, on a pot scale, to determine whether crops would respond to phosphoric acid fertilizers. It was found, as a result, that remarkably good results were obtained by the use of superphosphate on gram. This crop is not grown to any extent in the south of Bhagalpur, possibly, in part, owing to lack of moisture during the *rabi* (spring) season, but also, probably, because the lack of phosphates in the soil does not allow of a satisfactory return of crop. The main crop is paddy, and the problem at issue was to determine a system of fertilization which should increase this crop.

It was thought, since a leguminous crop had shown such response to the action of phosphates, that it would be advisable to include a leguminous green manure crop in the system of manuring. In consequence, a scheme was laid down in 1918 as follows :—

Control.

Green manure only.

„ „ plus apatite at rate 3, 6 and 9 mds.* per acre.

* 1 md. = 82² lb.

Green manure plus superphosphate 3 mds. (= 2 cwt. 20 lb. nearly) per acre applied at the time of sowing the green manure.

„ „ „ superphosphate same rate, half applied at the time of sowing the green manure and half at the time of puddling the soil for transplantation of paddy.

„ „ „ Basic superphosphate same rate and same treatment as superphosphate above.

Superphosphate alone.

Basic superphosphate alone.

The results which are given below (Table I) showed clearly

TABLE I.

Phosphate experiments with paddy at Kharara, 1918.

Type of manuring	Yields of grain and straw in lb. per acre		Increase over control	
	Grain	Straw	Grain	Straw
Control	1,065	1,904
Green manure only	1,185	2,276	+ 120	+ 372
„ „ + apatite 3 mds.	904	1,727	- 161	- 177
„ „ + „ 6 „	918	1,674	- 147	- 230
„ „ + „ 9 „	1,483	2,576	+ 418	+ 672
„ „ + „ 6 „	1,269	2,438	+ 20	+ 534
„ „ + „ 9 „	1,340	2,473	+ 275	+ 569
Super 3 mds.	1,165	2,168	+ 100	+ 264
Basic super 3 mds.	1,202	2,033	+ 137	+ 129
Green manure + super 3 mds. before sowing	2,194	4,761	+ 1,129	+ 2,857
Green manure + super 1½ mds. before sowing				
+ 1½ mds. at puddling	1,531	3,327	+ 466	+ 1,423
Green manure + super 3 mds. at puddling	1,367	2,526	+ 302	+ 622
Green manure + basic super 3 mds.	2,060	3,929	+ 995	+ 2,025
Green manure + basic super 1½ mds. before sowing				
+ 1½ mds. at puddling	1,710	3,669	+ 645	+ 1,765

that the influence of phosphatic manures alone was not likely to pay, but that the application of phosphates and green manure gave very marked results, which were worth following up. In consequence, in 1919, a series was laid down which omitted the phosphate treatment as such, and which only compared the effects of the usual treatment

with that of the use of green manure, with and without phosphates. This series was as follows :-

Control.

Green manure.

„ „ plus superphosphate at rates 1 cwt., 2 cwt., 3 cwt. per acre applied before sowing the green manure.

„ „ „ bonemeal same rates as superphosphate and same treatment.

Unfortunately, the local zemindar flooded the land just at the time when it was possible to sow the green manure, so that the crop was very much delayed, and, owing to this delay, very small crops were produced. The results, however, were striking, showing great increases from the use of the phosphatic manure, as will be seen from the table below (Table II).

TABLE II.

Showing the weight of dhaincha (Sesbania aculeata) obtained in 1919 in Kharara experiment plots.

Type of manuring	No. of experiments	Weight of dhaincha in lb. per acre
Control	4
Green manure only	4	830
„ „ + 1 cwt. bonemeal per acre	2	1,780
„ „ + 2 „ „ „	2	2,780
„ „ + 3 „ „ „	2	2,485
„ „ + 1 „ super	2	1,900
„ „ + 2 „ „	2	3,205
„ „ + 3 „ „	2	2,874

In 1920, the same series of experiments was carried out on the same plots as in 1919. This year was the first in which it was possible to carry out a detailed estimate of cost, as in previous years we had had to rely on the local zemindar for the cultivation and reaping of the crops. In 1920, however, by the courtesy of the Deputy Director of Agriculture, all the work was done by the department. Careful accounts were kept of all the expenses of cultivation

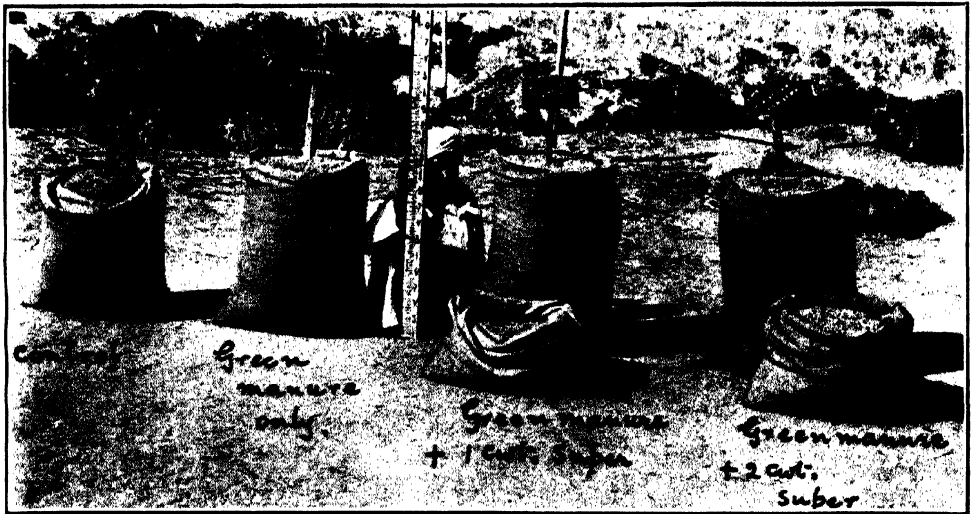
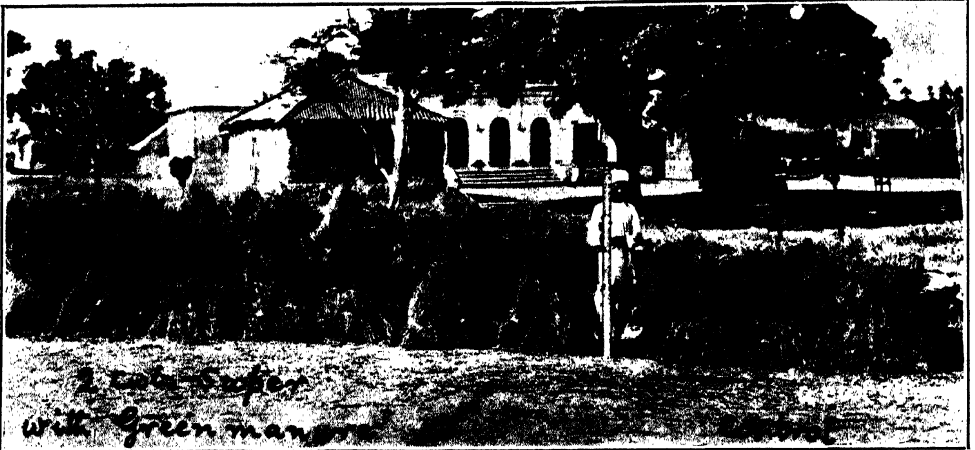

GREEN-MANURING OF RICE, 1920.

and manuring, and estimates were made of the profits made taking into consideration the current price of paddy. The results which were obtained were striking, as will be seen from the accompanying photographs (Plate II) and table (Table III).

TABLE III.

Phosphate experiment with paddy at Kharara, 1920.

Type of manuring	No. of experiments	Yield of grain per acre in lb.	Yield of straw per acre in lb.	Actual cost of cultivation and manure per acre to nearest anna	Net profit per acre (including 1920 price of grain and straw) to nearest anna
Control plots ..	4	1,261 (Standard deviation ± 208)	2,049 (Standard deviation ± 660)	Rs. 15-10	Rs. 53-4 Standard deviation \pm Rs. 10-10
Green manure plots	4	1,580 (Standard deviation ± 152)	2,675 (Standard deviation ± 323)	Rs. 23-15	Rs. 60-13 Standard deviation \pm Rs. 8-5
Green manure + 1 cwt. bonemeal	2	1,954 (Variations ± 47)	3,961 (Variations ± 278)	Rs. 33-14	Rs. 73-7 Variations \pm Rs. 3-1
Green manure + 2 cwt. bonemeal	2	2,074 (Variations ± 27)	4,718 (Variations ± 206)	Rs. 42-8	Rs. 72-12 Variations \pm R. 1-13
Green manure + 3 cwt. bonemeal	2	2,284 (Variations ± 72)	4,893 (Variations ± 459)	Rs. 51-4	Rs. 74-9 Variations \pm R. 1-1
Green manure + 1 cwt. super ..	2	2,280 (Variations ± 47)	5,098 (Variations ± 356)	Rs. 33-10	Rs. 93-9 Variations \pm Rs. 3-6
Green manure + 2 cwt. super ..	2	2,470 (Variations ± 82)	5,171 (Variations ± 284)	Rs. 42-2	Rs. 102-0 Variations \pm R. 0-13
Green manure + 3 cwt. super ..	2	2,418 (Variations ± 31)	6,193 (Variations ± 134)	Rs. 50-0	Rs. 87-12 Variations \pm R. 1-14

The above are calculated from the actual cost prices for fertilizers and labour in 1920. Superphosphate was actually obtained at the rate of Rs. 7 per cwt. in Calcutta, freight to Sabour actual 11 annas per cwt., and freight to Kharara calculated at 3 annas per cwt. At present rates for super Rs. 2-8 per cwt. must be deducted from the profits.

Bonemeal was obtained at Sabour for Rs. 7-8 per cwt., 11 annas freight, i.e., Rs. 8-6 per cwt. at Kharara.

It is of interest here to note the effect of the phosphatic fertilizer on the green manure. It was found that the fertilizer had the effect of quickening up the growth of the green manure to such an extent, that the fertilized plots were fit to plough in at the time of puddling. The unfertilized plots, however, produced such small crops of green manure by that time, that there was very little likelihood of much improvement from turning them in. A table follows which will illustrate these facts (Table IV).

TABLE IV.

Showing the weights of dhaincha obtained in 1920 at Kharara.

Type of manuring	No. of experiments	Weight of dhaincha in lb. per acre
Control	4
Green manure only	4	1,040
.. .. + 1 cwt. bonemeal ..	2	4,575
.. .. + 2	2	5,970
.. .. + 3	2	6,055
.. .. + 1 .. super ..	2	5,690
.. .. + 2	2	6,862
.. .. + 3	2	6,215

In 1921, the same series of experiments was carried out, and the same regard was paid to the profit and loss account as in 1920. Owing to the enormous price of superphosphate and other phosphatic manures, the profits obtained this year were not so good as in the previous one. Table V will show, however, that the same type of increase was shown in the crop this year, as in the previous one.

TABLE V.

Phosphate experiment at Kharara, Season 1921-22.

Type of manuring	No. of experiments	Yield per acre in lb.		Increase of grain over control	Value of increase to nearest anna (reckoning value of straw at 4 annas per md.)	Cost of manure including green manure seed per acre	Net profit per acre to nearest anna
		Grain	Straw		Rs. As.	Rs. As.	Rs. As.
Control	5	908	1,624
Precipitated phosphate + green manure	5	1,767	3,079	859	35 15	9 12	24 15
Super phosphate + green manure	5	1,793	3,069	885	36 14	14 12	20 14
Green manure only ..	5	1,420	2,262	512	20 11	1 12	17 11

The *dhaincha* was sown at 10 srs. per acre and taken @ Rs. 7-0 per maund = R. 1-12-0 per acre. The precipitated phosphate was applied @ $\frac{1}{2}$ cwt. per acre containing 35-38 per cent. P_2O_5 , costing Rs. 8-0 per acre. The super was applied @ $\frac{1}{2}$ cwt. per acre containing 40-45 per cent. P_2O_5 , costing Rs. 13-0 per acre. Freight has been charged at R. 1-4 per acre.

Owing to the obvious value of the method in that part of South Bhagalpur, a number of demonstrations were also undertaken by the department, which, in almost every case, showed a profit which would make it worth the cultivator's while to take up the practice.

In consequence plans were made to increase the area under demonstrations to a large extent during the present season (1922). Unfortunately, the season has been most unpropitious for work of this kind, and very few plots have been put down. In normal seasons, in this part of the world, one or two showers are expected towards the end of May on which the green manure can be sown. This is usually followed by a short, hot period, until the break of the rains, which takes place about the middle of June, or even later. The green manure crop has, by this time, sprung up and is well established. By the end of July the time at which the first paddy

is transplanted, the crop should be about 2·6" high, if it is manured with phosphates, and should give a yield of about 2 to 3 tons per acre. This year, not only were there no May showers, but there was continuous rain, throughout June and July, so that any plots that were sowed were so water-logged that the *dhaincha* (*Sesbania aculeata*) which was sown refused to grow. This year appears to have hit the one condition which renders the method bound to be unprofitable. Late rains do not appear to matter, so long as there is a reasonable "break." This is shown by last year's results, which were quite good, although the rains did not break until nearly a month late.

The soils on which these experiments were carried out was a poor sandy soil which only contained 0·036 per cent. total and 0·0009 per cent. available phosphoric acid. Owing to the fact that it contained also only 0·44 per cent. of lime, it was thought possible that the continuous treatment with superphosphate might have an unfavourable effect on its reactions. As laboratory tests appear to show that the soil is still faintly alkaline, even in the plots which were most heavily manured with superphosphate, it is assumed that the treatment is not doing the soil any material damage in this direction.

It is unnecessary to refer at any length to the fact that the leguminous crop has absorbed nitrogen from the air, before it is turned into the soil. Little is known as to the proportion which is absorbed from the air itself and from the soil. Experiments have been carried out, in different parts of the world, which prove that the amount actually taken from the air is much less in a rich soil than in a poor one, while in sand itself the whole amount is taken from the air. It is true that a certain amount of information is available of the amounts fixed by crops of clover, lucerne, or cowpea, grown in western countries, but, as the conditions of temperature and climate which control the activities of the nitrogen-fixing bacteria are entirely different from the conditions obtaining in India, and since the green-manuring crops themselves are different, the results obtained there could not be said to hold for this country. Hutchinson and Milligan (*Pusa Bulletin No. 40*) have estimated the

amount of nitrogen which is taken up by a sann (*Crotalaria juncea*) plant at different periods of its growth. The green-manuring plant which was used in the Kharara experiments was *dhaincha*, and it was thought desirable also to have some information as to the composition of this plant also, at different stages of its life-history.

Dhaincha is one of the crops greatly recommended as a green-manuring crop. It grows in the rains, when the temperature and moisture conditions of the soil are particularly favourable for the bacterial fixation of nitrogen. It is therefore of great interest to have an idea of the amounts of nitrogen fixed by this crop, under favourable conditions, at the various stages of its growth. Mere determinations of the soil nitrogen, before and after the crop has been ploughed under, are not enough, as it is difficult accurately to estimate by the usual methods the small amounts of nitrogen added. Further, although Harrison and Aiyer¹ have pointed out that the improvement effected by green manure in a paddy soil, which holds water for a long time, is not limited to the fertilizing effect of its nitrogen, yet it must be of interest to know the actual amount of nitrogen which it is possible to supply to a sand by the use of such a manure. It is also of value to know at what stages of the growth of the plant it performs this function of nitrogen supply most effectively. The plants were therefore grown in sterile nitrogen-free sand, and the amount of nitrogen found in them, at the different stages of their growth, was taken to be that fixed by them at those stages.

A great many precautions had to be taken to make the sand nitrogen-free. The sand used was fine river sand contaminated with small quantities of silt, and when freely washed with water still contained traces of nitrogen. To remove these the sand was washed again with dilute hydrochloric acid, and finally with nitrogen-free water. It was then ignited and put into beakers of different sizes so as to allow space for root penetration for bigger plants (which were put into bigger beakers) as they grew up. The whole was

¹ Harrison and Aiyer. *Mem. Dept. Agri. Ind., Chem. Ser.*, Vol. III, Pt. 3.

then again sterilized by being heated to steam temperature. Nitrogen-free water was then added so as to make up the moisture content of the sand to 20 per cent.

The seeds selected were fairly uniform in size and varied in weight by a few milligrammes only. Their nitrogen content was determined by taking bulk samples (whole seeds) and taking the average of six determinations. Before sowing, the seeds were sterilized by being immersed in mercuric chloride solution (1 to 1,000) for two to three minutes.

The plant food solution was prepared as follows: Calcium phosphate 1.0 gm., potassium chloride 1.5 gm., magnesium sulphate 0.5 gm., and calcium sulphate 1.0 gm. were mixed together and shaken up with two litres of nitrogen-free distilled water.

Inoculation was provided, when the seeds had sprouted, by crushing fresh young nodules (from the roots of plants growing in ordinary soil) with nitrogen-free water and adding a small quantity of the emulsion to the sand.

Watering with nitrogen-free distilled water and addition of the plant food solution were repeated at times as the plants grew up.

The first determination of nitrogen was made when the plants were seven days old. There were well-developed nodules observed even at that young stage. The amount of nitrogen then fixed by each plant of which the average dry weight was 0.035 gm. (green matter 0.398 gm.) was nearly 0.6 milligramme.

Afterwards there went on a steady rate of fixation of nitrogen along with the growth of the plants, until they were about seven weeks old. After this (leaving out a few abnormal cases) there appeared a sudden increase in the amounts of nitrogen fixed per dry weight of the plant. As, however, the growth continued and the weight of the plants increased, the percentage (but not the total amount) of nitrogen fixed gradually decreased. The results shewed that in 17 days the quantity of nitrogen fixed per plant was three times that contained in the seed and in 50 days this was about 150 to 200 times (Table VI).

TABLE VI.

Nitrogen fixed on dry or green weight.

Days	Percentage of nitrogen	
	on dry weight	on green weight
	Per cent.	Per cent.
0-20 ..	2.25	0.26
20-30 ..	1.90	0.23
30-40 ..	2.18	0.25
40-50 ..	3.16	0.37
50-60 ..	2.60	0.35
60-70 ..	2.20	0.30
70-80 ..	1.73	0.23

Assuming one plant on every foot square (as was allowed in the experiment), this would give 43,560 plants per acre and the quantity of nitrogen that would be added to the soil by such a crop of *dhaincha* would be, under the conditions of the experiment, as follows:—

Days	Dry matter per acre	Nitrogen added per acre
	gram.	gram.
0-20 ..	8,712	196
40-50 ..	45,508	2,702
50-60 ..	294,416	7,654
60-70 ..	610,711	13,434
70-80 ..	1,263,676	21,862

Allowing a 6" spacing, which is probably a better one for the plants of this size, we obtain from plants 50 to 60 days old 1,177,664 gm. of dry matter or 5,888,320 gm. of green matter and 30,616 gm. of nitrogen per acre.

It is not, however, the age of the plant alone which determines the amount of nitrogen fixed. A good deal depends upon the vigour and strength of the plants and the rapidity of the growth. In the present experiment the plants were growing most rapidly at the ages

between 6 to 8 weeks and the amount of nitrogen fixed per unit of dry matter was greatest at this stage (Table VI).

After the plants were several weeks old the amount of nitrogen was determined separately for the roots and the stems and leaves. In the sand the roots have not any difficulty in penetrating deep nor in getting the necessary air. The percentage of nitrogen was fairly large and amounted to 1.66 per cent. on the dry matter of the roots when the plants were 50-60 days old, the total amount being 0.039 gramme per plant. At 60-70 days the percentage was 1.80 and the percentage appeared to increase as the age increased.

It is also interesting to note that the amount of dry matter in the plants remained nearly constant at 11 to 12 per cent. of the total green weight until the plants were about 50 days old. After this there appeared a sudden rise in the percentage and the dry matter stood at nearly 25 per cent. until the time of flowering (Table VII).

TABLE VII.

*Relation of moisture and dry weight
with the age of plants.*

Days	Moisture		Dry weight	
		Per cent.		Per cent.
11	..	88.7		11.3
23	..	88.0		12.0
33	..	87.6		12.4
45	..	88.8		11.2
52	..	80.5		19.5
58	..	80.0		20.0
68	..	75.0		25.0

SOME ASPECTS OF AGRICULTURAL MARKETING AS ILLUSTRATED BY THE LYALLPUR CO-OPERATIVE COMMISSION SALE SHOPS.

BY

H. K. TREVASKIS, O.B.E., I.C.S.,

Deputy Registrar, Co-operative Societies, Punjab.

THE Lyallpur co-operative commission sale shops are attempting to solve a problem which is assuming world-wide importance. Many of the difficulties they have had to face have been met with in other countries, and the main principles underlying their working are governed by the same fundamental economic laws as obtain elsewhere.

MARKETING A PART OF PRODUCTION.

The problem set for them to solve is that of marketing. It is a fundamental one. For, economic processes may be divided into Production and Consumption. Wealth is increased by increasing production or diminishing consumption. Production is increased by diminishing its cost. Now "the cost of production includes the cost of all those processes antecedent to the receipt of the thing produced by the person whose consequent disbursement makes the price that we are studying."¹ Production may, therefore, be divided into (1) manufacturing (or crop raising), (2) marketing. Marketing begins where the manufacturing process ends.² "In discussing the relation between prices and costs of production, economists have too generally considered only the factory or farm costs; they have not given sufficient attention to the fact that marketing costs must also be included in determining the relation between supply and demand."³

¹ Chapman, S. J. "Political Economy," pp. 76, 77.

² Weld. "The Marketing of Farm Products," p. 6.

³ *Ib.*, p. 249.

MARKETING PROBLEM IN FRANCE.

The importance of marketing has grown with the growing complexity of the economic world. The ancient world was, and backward parts of the world still are, to a large extent, self-sufficing; but agricultural progress is marked by the transition from the self-sufficing to the commercial stage, which follows on improved communications.¹ This may be illustrated from the agricultural history of France.

“The size of Paris, Lyons and the other leading cities necessitated, for centuries, a large-scale organization of the food trades, especially the grain trade. This had broken up effectually the old system of localized supply of local requirements. Markets were wide, remote, and foreign.”² “As the country developed, road, canal, or, later, an early railway linked up a low price area to some great market, and brought its prices up to metropolitan level.”³ “Highly specialized agriculture was difficult before the modern transport age. It was only after good roads and railways had become general, and had been supplemented by the telegraph for market news, that any district could easily afford to specialize on some class of produce for which there were good markets at a distance.”⁴ Thus with the commercial stage of agriculture came the necessity for organized marketing. The wealth accumulated by those who were the first to realize this is illustrated by the prosperity of ancient Tyre and Carthage, mediæval Genoa, Venice, and Holland, and London in more modern times. The tendency was for such cities to absorb all surplus wealth, leaving the producer still on the margin of subsistence. “Even now it is a weakness in our economic machinery that dealers and brokers seem on the whole to be more prosperous than the actual producers of the goods they handle, and that trading towns are more wealthy than the purely industrial or producing places.”⁵

¹ Calvert. “Wealth and Welfare of the Punjab,” pp. 11, 12.

² Clapham. “The Economic Development of France and Germany,” p. 29.

³ *Ib.*, p. 30.

⁴ *Ib.*, p. 45.

⁵ Hartley Withers. “Poverty and Waste,” p. 119.

MARKETING PROBLEM IN ENGLAND.

In order to effectually emancipate himself, the producer must first learn to produce what the market requires. Production is (or should be) governed by the market.¹

“ Educational and research work in agriculture which takes no account of the dominant importance of economics must always be ill-balanced and incomplete. (Given the necessary capital and labour, conditions may be contrived under which any soil may be made to produce any crop, but the wisdom or otherwise of embarking on any particular form of production can be determined only by a study of economic forces.”² But the producer must not only grow what the market requires, he must also arrange for marketing in a business-like way.

“ A matter of the utmost importance to the English farmer and public alike, and one which is crying out for investigation on a large scale, is the distribution and marketing of farm products.”³ Only in this way can the producer get a fair share of the price. “ The disparity between the retail prices paid for market garden produce in the big towns and the small portion of those prices received by the growers is utterly indefensible.”⁴ “ The belief is widely shared that the brightest hope for agriculture lies in more enlightened business methods. Increased and cheaper production will not alone put the industry upon a secure and strong footing. The greatest weakness is on the business side of farming. The systems of marketing are lamentably defective, as is shown by the wide margin between wholesale and retail prices. The producer sometimes does not receive much more, and occasionally less, than half what the consumer pays. The various grades of middlemen, who among them claim as much as is received by the man who incurs all the cost and risks of producing the material, may not be unduly rewarded, but there would seem to be need for reform in systems that entail so great a cost in passing the articles from the

¹ Calvert. “ The Wealth and Welfare of the Punjab,” p. 49.

² C. S. Orwin in address to the British Association, Sept. 1921. *Agri. Jour. India*, XVII, p. 271.

³ *Ib.*

⁴ Board of Agriculture and Fisheries, Cd. 8182, 1916.

farm or farmers' station to the householder."¹ For this purpose marketing ability of a constructive order is required. This "is to be clearly distinguished from a laborious astuteness in bargaining, on which people with small capitals, and especially agriculturists, in all countries often lay stress. That miserable ingenuity is no doubt barren: it is the one side of trade, which is amenable to the old sweeping charge against all trade, *viz.*, that in it no one can gain save at the expense of another; and that the more energy is diverted to it the poorer will a country become. The constructive trader on the other hand aims high and sees far: he is constantly forecasting future developments of demand. For this task elasticity of mind and delight in hard work are needed."²

MARKETING PROBLEM IN INDIA.

The necessities, which have been thus manifested in England, have their counterpart in India. For, while large parts of the country are still in the self-sufficing stage, the opening up of communications has enabled commercial agriculture to be undertaken in many favoured regions.

Lyallpur is the centre of such an area. The development of irrigation combined with access by rail to the sea and other parts of India³ have enabled a large exporting industry to be developed in wheat, cotton, and oil-seeds, while sugar also is exported to outside areas. Wheat, as distinguished from other food crops, has an international value, due to the fact that it can be (a) easily stored, (b) transported, and (c) graded,⁴ while it is in demand almost everywhere at all times, the demand being relatively constant. Under these circumstances it was natural that the marketing problems which have arisen elsewhere should manifest themselves in Lyallpur. German example has shewn that to be successful co-operative marketing should be in an exporting area,⁵ and it was

¹ *The Times*, 17th July, 1922.

² Marshall. "Industry and Trade", I, iii, 5.

³ Calvert. "The Wealth and Welfare of the Punjab," p. 54.

⁴ *Ib.*, p. 144.

⁵ Darling. "Co-operation in Germany and Italy", para. 63.

natural that Lyallpur should be selected for the first experiment in co-operative sale in the Punjab.

IMPORTANCE OF FINANCE.

The central problem is one of finance. Some form of financial arrangement is inevitable owing to the time between the delivery by the farmer and the recovery of the price by the retailer.¹ This is illustrated by the agitation in Canada for the restoration of the Wheat Board formed during the War to take over wheat from growers. "The idea underlying it is that the growers require financing in order not to be forced to sell their crops too early. It has been found that if this be done it simply means that speculators step in and secure the grain and hold it for higher prices."² Generally the middleman's services may be said to be (1) wholesale purchase and retail selling, (2) provision of capital to bridge the time between purchase and sale, (3) taking risks of deterioration.³ But in Lyallpur the problem is still further complicated by the fact that many of the zemindars⁴ are heavily indebted. The debts incurred are almost entirely non-productive and are heaviest in the most prosperous districts,⁵ in which moneylenders congregate as flies over jam. But the debt is the result and not the cause of prosperity. The indebtedness of the small-holder to the village moneylender is being steadily removed by the local village co-operative society. But the experience of the commission shops is disclosing that indebtedness is not confined to the small-holder. Big landowners, with every outward sign of prosperity, are often heavily indebted to the *ahrtis* (commission agents) of the *mandis* (markets), who spare no pains to entangle them into permanent indebtedness. This indebtedness is generally unsuspected by the outside world, but its existence would explain the neglect of many of the larger

¹ Weld. "The Marketing of Farm Products," p. 55.

² *The Pioneer*, 8th October, 1922.

³ Hartley Withers. "Poverty and Waste," p. 118.

⁴ For the benefit of non-Punjab readers it may be explained that in the Punjab the term *zemindar* is used of any landholder however small. The average Punjab holding is only about 7½ acres (Calvert. "Wealth and Welfare of the Punjab," p. 74), but near Lyallpur it is larger, about 20 acres.

⁵ Calvert. "Wealth and Welfare of the Punjab," p. 123.

zemindars to assist the co-operative movement. A debtor is the slave of his creditor, he is no longer a free man.

AGRICULTURAL INDEBTEDNESS.

An important result of this indebtedness was the control by the *ahrti* of the crop supply.¹ The big landholders, who borrowed from him direct, were compelled to bring their crops to him after harvesting. The small-holders, who dealt with the local money-lender, brought their crops to the latter, and he forwarded them on to the *ahrti* on whom he also was dependent. The value of the crops harvested was credited to the zemindars at the price then prevailing, a price which was necessarily low owing to all the produce being thrown on the market at the same time. Once the produce had all come in the price rose, and the *ahrti* reaped a rich reward. He therefore profited (*a*) from buying cheap and selling dear, (*b*) from interest on loans, and (*c*) from commissions and other imposts charged on sales. These last, though not inconsiderable and though many have been successfully abolished in the co-operative commission shops, are not the real source of wealth to the *ahrtis*. It is from their immense profits under (*a*) and (*b*) that they have been able to accumulate nearly all the wealth of the rich district of which Lyallpur is the centre.

FINANCIAL ARRANGEMENTS OF THE COMMISSION SHOPS.

It was, therefore, discovered that it was useless to tackle many of the finer and more interesting problems of marketing, such as grading, futures, elevator storage, terminal marketing, etc., until this elementary though formidable difficulty had been removed. The question was handled by the local Co-operative Inspectors and the Lyallpur Central Co-operative Bank with characteristic courage and resource. The Manager and Committee of this body are characterized by a combination of financial shrewdness with a working knowledge of agricultural problems. One of the zemindars' chief difficulties lay in the necessity for immediate sale of their produce at

¹ Calvert. "Wealth and Welfare of the Punjab," pp. 124, 127.

artificially low prices. This was met by the commission shops arranging to advance 75 per cent. of its value on all grain brought in whether sold or not. When the zemindar wished to store, the shop made arrangements for his doing so. Such advances were fully secured by the produce held, and the Central Bank could safely make advances to the commission shops on the grain held by them for the zemindars. Those who were permanently indebted had to get their advances through their village societies. Experience shows that it is only local men who can adequately test a man's ability to repay; the attempt to centralize agricultural credit proved a weakness in early French co-operation.¹ But the Central Bank on the advice of the Inspectors made judicious advances to village societies, whose members wished to market through the commission shops, and were only prevented from doing so by their indebtedness to *ahritis*. In these two ways the first great obstacle to co-operative marketing was removed. A further facility was provided by making small advances up to Rs. 50 to approved gentlemen dealing with the shop, who found themselves in Lyallpur without any money. A trivial matter possibly; but not altogether negligible in oiling the wheels of the machinery, as anyone who has found himself in a large town without any ready cash will realize.

INCREASE IN WHEAT SALES.

The results have been apparent in the rise of the sales (up to the middle of Sept. 1922) of wheat alone from 650 tons last year to 2,300 tons this year. (This is for all five shops, the figures for Lyallpur alone being 300 and 1,050 tons respectively). The amounts may appear small, though the rise is significant, but the figures conceal a very important fact. Last year practically all the wheat had come in by August, while this year it is estimated that more than half the total produce has been held up. As to whether in each particular instance a zemindar was wise in holding up is not the point. The important fact is that the commission shops put him in a position to do so if he wishes. And undoubtedly the general

¹ Nicholson, F. A. "Report regarding the possibility of introducing Land and Agricultural Banks into the Madras Presidency," p. 149.

hold-up has helped to prevent a panic slump in prices. The zemindar by controlling supply can prevent prices from falling below what is reasonable.

WHAT IS A REASONABLE PRICE ?

A reasonable price is theoretically one which will just compensate the holder of that land, which can only just pay for growing wheat, for its production.¹ Practically it is that which will compensate an ordinary owner for all his expenditure (including rent ; or interest on the price of land, which in Lyallpur has often been purchased by the owner). Now, owing to the increase in the cost of necessaries, this cost of production has risen. The result is to throw out of cultivation the marginal lands *i.e.*, those lands which will only just pay to grow wheat, and so to diminish supply until the price rises to an amount sufficient to compensate growers.² This both explains and justifies the rise in price of agricultural produce, which necessarily follows on the rise in the cost of the other necessaries of growers (*e.g.*, salt, clothes, etc.). As to how far this rise is due to the diminished production caused by the war, how far to an inflated currency, and how far to a protective policy it is difficult to determine. Experience seems however to justify the theoretical dictum that a protective tariff in favour of industries tends to hinder the development of the agricultural resources, and therefore also of the commerce of a country.³ This tendency is illustrated in Kangra, a hill district of the Punjab, where labour is no longer forthcoming at the rates landlords are prepared to pay. The lands on the margin of production are going out of cultivation, and tenants are leaving for the plains, generally to swell the urban industrial population.

REDUCTION IN RATES.

Sales are made by the commission shops to a broker on behalf of the producer. The commission charged is As. 8 as against As. 12 per cent. charged by an *ahrti*. In addition to this the *ahrtis* make the producer pay for the *paledar* who empties and

¹ Chapman. "Political Economy", ch. viii.

² *Ib.*, ch. viii.

³ Marshall. "Industry and Trade," app. G. 2.

fills the bags, the *toledar* who does the weighing, the *changar* who separates the dust from the grain, and to a fund for charity and the maintenance of the *gaushala*. For these the *ahrti* charges As. 14 per cent. ; the commission shops only As. 10 $\frac{1}{4}$ per cent. Apart from this the *ahrti* also charges for the *lungri* (cook), the *bhisti* (water-carrier), and the sweeper, who are paid in kind out of the grain heap, *i.e.*, by the producer. It is often surmised that under cover of these latter charges the *ahrti* makes further appropriations himself. A big landowner, living near Lyallpur, sent some of his produce to an *ahrti*, and some to the commission shop. He weighed both amounts beforehand, and found that while the shop credited him with full weight the *ahrti*'s estimate was considerably less. In this way the shops are building up a reputation for honest dealing as well as for lower prices.

It may therefore be claimed that the commission shops have already done something to enable their clients to reap the full fruits of their labour. This is the more remarkable as they have received no special financial assistance from the State, though, as we have seen,¹ such help has been claimed in Canada, and in Germany has been given freely.²

SALE BY COMMISSION.

Sale by commission is the ordinary Lyallpur market method. The system works well in practice, and saves the shops all risks due to possible fluctuations in prices. None of the dangers from fraud, which seem to exist in America,³ have been experienced. Dishonesty is fortunately unknown amongst the shop managers, and the committees are keen and alert. Nevertheless, while the present system is eminently suited to the present situation, German experience would seem to indicate that the ideal system would be for the shop to purchase outright.⁴ But in such cases it seems desirable for the shop to protect itself against price fluctuations by hedging in the future market, storing the grain (if possible in an

¹ See above, p. 119.

² Darling. "Co-operation in Germany and Italy," paras. 68, 79.

³ Weld. "The Marketing of Farm Products," p. 84.

⁴ Darling. "Co-operation in Germany and Italy," para. 69.

elevator, such as the one in Lyallpur), and then selling a large quantity together. But this postulates a properly developed future market, which would enable sellers and brokers to insure against price fluctuations, with specialists who devoted especial study to that matter.¹ Such a market can hardly yet be said to have developed satisfactorily. There is even an inclination to condemn dealings in futures as speculative, though the experience of other countries would show that their ultimate tendency is in the opposite direction.²

GRADING OF WHEAT.

Future trading would obviously be impossible without a proper grading of products.³ But on other grounds too proper grading is a consummation devoutly to be wished.⁴ Co-operative sale in Ireland felt the need of it,⁵ while in Germany it has resulted in higher prices and improved farming.⁶ It enables sale by sample or description instead of in bulk, and the use of warehouse receipts for grain stored in an elevator. Grading is easiest when the article concerned is (a) non-perishable, (b) consists of similar units, (*e.g.*, kernels of wheat), (c) does not vary from year to year, and (*d*) is of equal value to all consumers (*e.g.*, wheat as against barley, which is only required for special purposes).⁷ In all these qualities wheat is pre-eminent, and its grading should be simple. Unfortunately, however, the grades fixed by the big exporting firms at Lyallpur are rather adapted to the dishonesty of the *ahrti* than the straightforward dealings of the zemindar. The zemindar's wheat is nearly pure. But the standard required by the exporting firms allows for $1\frac{1}{2}$ per cent. of dirt and 2 per cent. barley. Theoretically, it is true, more is allowed for purer wheat. But practically it is more profitable for a broker to mix his wheat with dirt and inferior grain than to take the allowance. As a result the commission shops find

¹ Weld. "The Marketing of Farm Products," ch. xv.

² *Ib.*, p. 317. Clapham. "The Economic Development of France and Germany," p. 92.

³ Weld. "The Marketing of Farm Products," p. 362.

⁴ Clapham. "The Economic Development of France and Germany," p. 92.

⁵ Smith-Gordon and Staples. "Rural Reconstruction in Ireland," p. 124.

⁶ Darling. "Co-operation in Germany and Italy," p. 79.

⁷ Weld. "The Marketing of Farm Products," ch. xvii.

it necessary to deal with these expert mixers, who will pay them a premium on pure wheat, rather than with the exporters direct. Endeavours are being made, however, to get the standard raised, and it is hoped that they will eventually be successful. Much of the odium attaching to Indian wheat at Liverpool is due to the fact that it is mixed with this unnecessary dirt; which benefits none but those who have turned dishonesty into a cult.

One commission shop, in an area where market-gardening is practised, sells potatoes. In this case proper grading is impossible, but much may be done by selection, *i.e.*, selecting the best potatoes and selling them separately. Unless this is done the tendency is for all to fetch the price of the worst.¹

CO-OPERATIVE SPIRIT.

Problems of finance are inherent in marketing as a part of production.² Co-operative marketing has problems of its own. "Unless marketing facilities are actually non-existent, a farmers' organization must compete with experienced specialists already in the field, and unless it can perform the service with greater efficiency or by eliminating some wasteful method, there is no reason for its existence."³ It is of the essence of co-operation that it should satisfy a common need.⁴ That the need exists has been sufficiently shewn. But it must also be felt. And two of the shops, where it has been strongly felt, and where consequently the co-operative spirit is high, have thereby been able to overcome obstacles of exceptional difficulty.

QUALIFICATIONS OF MANAGEMENT.

But even enthusiasm may be misguided. In America "failures" in co-operative sale "are largely due to inefficient management," due to the unwillingness of farmers to pay adequate salaries.⁵ In

¹ Weld. "The Marketing of Farm Products," p. 363.

² *Ib.*, p. 55.

³ *Ib.*, p. 409.

⁴ Calvert. "Law and Principles of Co-operation," p. 12.

⁵ Weld. "The Marketing of Farm Products," p. 409.

the Lyallpur shops there is a general tendency to under-estimate the value of efficient management, and to condone incompetence when it is cheap. In one shop this almost led to failure, which was only retrieved by appointing an efficient business man as manager. The example of Germany is very much in point. There "too often the local man, who was appointed because everyone knew and trusted him, lacked the experience and capacity indispensable to an undertaking requiring the greatest vigilance and care."¹ It is difficult to find "a manager who is both an agriculturist and a man of business . . . and it is usually a question which type should be chosen, the agriculturist who has no knowledge of trade, or the trader who has no knowledge of agriculture. For the corn trade the latter is safer If a society cannot have two managers, or if the ideal combination in one man cannot be found, it is better, anyhow at the outset, to have a man who had some knowledge of trade. It is an advantage of the larger central organizations that they can usually afford to employ both together."² In the Punjab the distinction between agriculturist and non-agriculturist is far more pronounced than in Germany, and the same question has arisen in a more acute form. Each shop has a manager and an assistant manager, both originally agriculturists in all the shops except that of Lyallpur itself, where a young *bania* (*i.e.*, of the business class), from a distant district, was assistant manager. His knowledge of market methods proved invaluable to inexperienced co-operators, while being a Hindu he was better able to keep in touch with the other (Hindu) commission agents of the *mandi*. Since then a business man has been appointed at Chak Jhumra with very encouraging results. Gojra being under the influence of a large local zemindar with business experience, the question does not arise there in an acute form. In Toba Tek Singh keen co-operative spirit runs somewhat counter to business instincts. Keen agriculturists are slow to appreciate business qualifications. They have an inborn, and perhaps not altogether unjustifiable, distrust of the business man; a distrust which may be carried to extremes.

¹ Darling. "Co-operation in Germany and Italy," p. 67.

² *Ib.*, p. 70.

Business-like methods are necessary to all co-operative societies,¹ and are vital here. It seems wisdom on the part of the shops to avail themselves of the experience of those who have had a business training. The *ahrtis* also will be less hostile to co-operation if they feel that they are not as a class entirely excluded from its fold. As a result of these considerations the working rule has been arrived at that of the manager and assistant manager one should be a business man and one an agriculturist, the business man being imported from some outside district so as to prevent his being in league with the local *ahrtis*. The necessity of having one of the managing staff an agriculturist requires less emphasis, though it is equally important.

UNIFICATION.

German experience as to the value of unification seems also applicable to the Punjab. Cheap managers are inefficient, well paid managers are too expensive. A united organization can pay better. "The financial resources of a large organization are far greater than those of a small society. It can work with the economy and efficiency of management that modern conditions demand. Co-operatively, however, there is room for regret, for it is in the smaller societies with their strong local ties that the co-operative spirit can be most richly developed. Thus, as so often happens, material and moral gain are opposed."² These words might have been written of the Punjab. The burden of managerial expenses weighs heavy on these five shops, nor do they provide results at all in proportion to the expenditure. As the shops exist now it would be difficult to unite them without destroying their individuality, though the possibility is not being lost sight of. But in any further extension of the movement one organization would seem ample for each district, with its headquarters at the main business centre and branches where necessary. It could then afford to have one well-paid manager who could take broad views and would not be immersed

¹ "Report of the (Maclagan) Committee on Co-operation in India," 1915, Abstract Report, para. 2.

² Darling. "Co-operation in Germany and Italy," para. 66.

in the petty routine of each separate shop. An assistant manager would then suffice for each branch. Such a shop would be in a much better position to deal with the big exporting firms direct, who like to do business on a large scale. The difficulties of the Salarwala shop are already being met in this way. It has a large godown by the side of the railway in the centre of a rich wheat-producing area. But the lack of a *mandi* at Salarwala made sale difficult. By removing the headquarters to Sangla Hill Junction, where there is a large *mandi*, leaving Salarwala as a branch, the area of the shop has been increased, while the wheat stored at Salarwala can be sold at Sangla, and then railed straight to its destination without the expense of actually bringing it to Sangla.

COMBINATION OF SALE WITH SUPPLY.

Expenses of management can also be reduced by combining agricultural supply with sale. Co-operative supply also suffers from the expense of efficient managers, but when it is combined with sale and both are under the same management, expenses are shared. In the case of German co-operative granaries "experts are emphatic that the sale of grain should always be combined with agricultural supply."¹ The Grain Growers Co. (of Canada), one of the largest experiments in co-operative sale in the world, supplies its members with coal, timber, and flour from its own mill.² In Lyallpur a beginning has been made. Salt and standard cloth are being supplied and other simple necessities are under consideration. One shop has the agency for the supply of seed issued by the Agricultural Department. Supply transport charges are minimized, as the shops are all near the railway. When growers have sold their produce, and have money at hand, they are particularly willing to purchase. This avoids the necessity for granting credit, the nightmare of co-operative supply. The relative failure of other supply societies seems to indicate that for either co-operative supply or sale to be successful they must combine.

¹ Darling. "Co-operation in Germany and Italy," para. 64.

² Weld. "The Marketing of Farm Products," pp. 421, 425.

TERMINAL MARKETING.

Other proposals are in a tentative stage. It is necessary to walk warily, and to reject some projects, *e.g.*, dealing in futures,¹ for which, sound though they are, the country is not yet ripe. The success of co-operative terminal marketing in Denmark, California, Minnesota, and Canada² points the way to direct sale to Karachi, and one enterprising co-operator even looks forward to direct sale to England. Such a project must, however, be relegated to a future time when the shops control an appreciable proportion of the total wheat and other produce.³

COTTON GINNING FACTORIES AND OIL-PRESSES.

More essential are co-operative ginning factories for cotton.⁴ The question of acquiring one is now being considered by the Lyallpur shop. The value of an assured supply of cotton is now being realized in England, and a recent article has drawn attention to the necessity for encouraging growers.⁵ This points to a distant future when growers and manufacturers may deal directly with each other. This again will only be possible when the shops control a large proportion of the output, the first step towards which is the co-operative ginning factory. Its counterpart is a co-operative oil-press to deal with oil-seeds. By thus advancing the products one stage it is possible to economize considerably in weight and thus reduce the freight charges to Karachi.⁶

EDUCATIONAL VALUE OF SHOPS.

Such questions come under discussion before the shop committees and the ability with which they are handled by members, some of whom are illiterate, and very few of whom know English, is sufficient proof of their educational value. Other simple

¹ See above, pp. 123, 124.

² Weld. "The Marketing of Farm Products," pp. 419, 420.

³ See above, pp. 124, 127.

⁴ Powell, W. W. *Bombay Co-operative Quarterly*, June, 1922.

⁵ Sir Charles Macara in *Textile World*, LXI, No. 24; reprinted in *Agri. Jour. India*, XVII, No. 5, September, 1922.

⁶ Calvert. "The Wealth and Welfare of the Punjab," p. 165.

but fundamental business matters bearing on marketing have been investigated. Rates of transport per maund-mile have been found to be by rail 4 pies, by *kachcha* (country) road 3 pies, and by *pakka* (metalled) road 2 pies. These, of course, only hold for distances within which a bullock-cart can go and return within a day (*i.e.*, about 10 miles radius). Still it is interesting to discover that between adjacent stations, *e.g.*, Salarwala and Sangla,¹ road transport is cheaper than rail. The cost of storing wheat works out to about two annas a month per maund the first month and one anna a month after. In this the interest charge (about 8 pies per maund per mensem) is the most important item. Thus roughly if wheat is expected to rise more than two annas a month it will pay to store, otherwise not; allowing another anna for deterioration.

But while the shops develop business acumen they are bound by strictly co-operative principles. The bye-laws permit, after the placing of a quarter of the profits to reserve, the granting of a bonus of not more than three months' pay to employees and of a dividend not exceeding 8 per cent. on share capital. Out of the balance, a rebate may be distributed to members in proportion to their transactions.

CO-OPERATIVE SALE THE CULMINATION OF CO-OPERATIVE CREDIT.

The shops are co-ordinated with the village co-operative credit societies within their area, most of whom send their produce to them. But their clientele is by no means limited to village co-operators, though it has a tendency to join village societies or found new ones. In fact co-operative sale is the necessary culmination of co-operative credit. To repay his loans to the village credit society the zemindar must sell his produce, and, without co-operative sale, he is compelled to resort to the only alternative, a broker, who is also a money-lender. Thus the village society does not completely relieve its clients. Of great, though less, importance, is the financial simplicity introduced by the shops which can relieve the village societies of half their work and responsibility.² They also solve the

¹ See above, p. 128.

² See above, pp. 120, 121.

problem of agricultural supply.¹ It is therefore hardly too much to say that while the village credit society is the base, the sale shop is the superstructure of the co-operative edifice.

SUMMARY.

To sum up, the increasing importance of marketing is due to the growing complexity of economic processes. The phenomena have long been present in Europe and are now manifesting themselves in India. Financial backing is everywhere essential, but in India especially so owing to the widespread indebtedness of the agricultural population, which has thereby been reduced to a state of economic servitude to the financial classes. The financial arrangements of the Lyallpur commission shops have resulted in a threefold increase of business, and the freedom of the grower from the necessity of forced sales at inadequate prices. These arrangements were made without any financial assistance from the State. The usual market method of sale by commission has been adopted, though at reduced rates. No improvement on this seems desirable till a proper "future" market is developed. The questions of terminal marketing and co-operative cotton ginning must also be postponed, but grading and transport problems are being effectively tackled. German practice, which indicates the importance of efficient management, a unified organization, and the combination of sale with supply, is endorsed by Punjab experience. But though business-like, the shops are also co-operative both in spirit and in physical union with the co-operative movement as a whole. And co-operation is no mere shibboleth. Co-operation is made for man, not man for co-operation. It is justified by its results, the emancipation of the population from economic slavery.

"Ill fares the land, to hastening ills a prey,
Where wealth accumulates, and men decay
Princes and lords may flourish or may fade,—
A breath can make them, as a breath has made;
But a bold peasantry, their country's pride,
When once destroy'd, can never be supplied."²

¹ See above, p. 128.

² Goldsmith. "The Deserted Village."

A PRELIMINARY ACCOUNT OF SYMBIOTIC
NITROGEN FIXATION IN NON-LEGUMINOUS
PLANTS WITH SPECIAL REFERENCE
TO *CHOMELIA ASIATICA*.*

BY

K. ADINARAYAN RAO, L.A.G.

It is common knowledge that certain plants have knob-like growths on their roots. A gram or a groundnut plant shows clusters of roundish bodies attached to the roots. Although these nodules were at one time thought to be pathological they have been conclusively shown to be indispensable for the healthy growth of the particular plants with which they are associated. This work was mainly done by Hellriegel and Wilfarth between the years 1886 and 1888. They clearly showed that the nodules are the means of providing the host plant with combined nitrogen obtained from the atmosphere through the activity of the bacteria inhabiting the nodules. It thus became clear that the practice of growing plants for enriching the soil was not quite unfounded. Once this was proved to be the fact, other scientists set to work with the idea that it was possible that plants of other Orders might under similar conditions fix atmospheric nitrogen. In temperate climates several plants readily lent themselves as objects for confirmation of this view. These were :—

- (1) The Alder (*Alnus*).
- (2) The Elægnus (*Elægnus latifolia* Linn.).
- (3) The Podocarpus (the white pine) (*Podocarpus latifolia*).
- (4) The Cycas (*Cycas circinalis* Linn.).

* Paper read at the Ninth Indian Science Congress, Madras, 1922.

Investigations were directed to other parts of the plants, namely, the leaves, the leaf-margins and the seeds, and a larger number of plant Orders were examined. The rapidity of vegetative growth in the tropics led scientists to direct their attention to those regions for testing their theories.

In 1894 Trimen drew attention to the small knob-like excrescences on the leaves of certain Ceylon Rubiaceæ.

Zimmermann (1902) recognized the constant presence of bacteria in these structures in at least four species from Java and referred to them as bacterial knots. He did not, however, take up the question of the origin of the knots, and von Fabre went to Buitenzorg in 1910 to make an extended study of the problem and investigated the symbiotic relations of five species (1911). He¹ not only accepted Zimmermann's theory that the outgrowths were due to bacteria but went a step further and proved that these bacteria had the remarkable property of fixing the nitrogen of the air (1911, 1912 and 1914).

Miehe² (1916) took up another Order of plants—Myrsinaceæ—and came to the same conclusion as Fabre. His "leaf-teeth" in *Ardisia crispa* corresponds to Fabre's "leaf-nodules" of Rubiaceous plants. Furthermore, Fabre and Miehe have shown that the symbiosis between their respective plants and the bacteria contained in them is one of hereditary character.

India abounds in such plants but until now no work of the kind has been done here, and this preliminary paper is simply an account of what has been attempted at Coimbatore in the case of a few South Indian plants. The species examined for leaf-nodules are :—

- (1) *Chomelia asiatica*.
- (2) *Pavetta indica*.

¹ von Fabre, F. C. Das erbliche Zusammenleben von Bakterien und tropischen Pflanzen. *Jahrb. Wiss. Bot.*, 51, pp. 285—375, figs. 7, pls. 3, 1912. *Jahrb. Wiss. Bot.*, 54, pp. 243—264, figs. 3, 1914.

² Miehe, H. *Berd. d. Bot. Ges.*, XXXIV Bd : p. 576, 1916.

Chomelia asiatica is an example of a Rubiaceous plant having nodules on the leaves and thus becomes a further instance of this phenomenon. As far as can be ascertained by studying the literature on the subject of leaf-nodules, no mention of their presence on the leaves of *Chomelia asiatica* has been made. *Pavetta indica* which is equally common and which has been fairly well studied was taken up for purposes of comparison.

Twigs, leaves, flowers and seeds of both the species were obtained from the different forest areas of the Presidency and examined. As a matter of convenience leaves were sorted out into three classes, young, medium and old, based on their appearance. Intermediate stages were merged into the classes to which they approximated. Only typical leaves were taken for purposes of study.

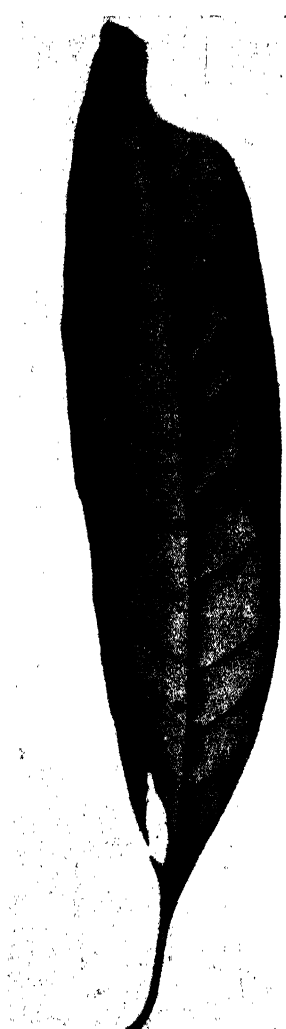

Chomelia asiatica.

Chomelia asiatica.

This plant is called "Karannai" in Tamil and abounds in moist forests on the ghats and in southern parts of the Western Peninsula and also in Ceylon and the Malay Islands. In the dry country, the leaves, the inflorescences and the fruits are smaller than in more humid districts.

As an undershrub it is very commonly met with in Madras at 1,000 to 2,000 feet elevations. The leaf-blade contains characteristic bacterial knots (10 to 12 on each leaf) situated at the junction of the veins with the midrib.

Pavetta indica.

A small tree with numerous branches and called in Tamil "Pavettam" and in Telugu "Papata."

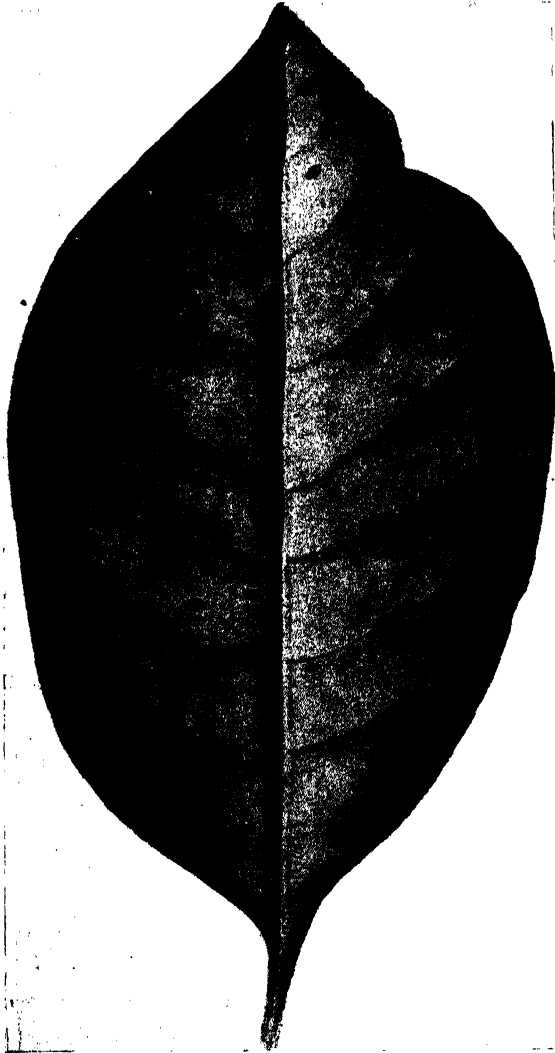

Pavetta indica.

Leaves, variable in shape and size, simple, opposite obtuse or lanceolate, dark green and glossy with bacterial nodules

scattered all over the leaf with great regularity. The number varies from 50 to 100 on the surfaces of leaves of some varieties.

It occurs throughout India from the Western Himalayas to Bhutan and southwards to Ceylon, Malacca and Penang.

DESCRIPTION OF NODULES.

Both in wild and cultivated plants of the foregoing species, various sized nodules occur on the upper side. These are usually of a darker appearance than the rest of the leaves and can be clearly seen. The nodules are generally round and rarely of irregular form.

In some varieties of *Pavetta indica* which occur in Trichinopoly forest areas, the nodules are characteristically darker than the rest of the leaf tissue and look very prominent when held against the light.

ANATOMY OF THE LEAF WITH REFERENCE TO LEAF-NODULES.

Even in the unopened buds of the plants referred to the bacteria are to be seen among the leaf primordia. Stomata serve as organs of entrance into the leaves as they develop and the bacteria pass into intercellular spaces and penetrate therefrom everywhere between the tissues of the leaves and collect into the air holes. Afterwards peculiar changes in the nuclei take place and the cells begin to divide vigorously. A special bacterial tissue is formed and could be easily distinguished from the rest of the leaf tissue by means of a characteristic sheath. The leaf begins to swell on the affected side. The stomata seem to arch over and thus imprison the bacteria that have gained entrance into the leaf. The bacterial mass possesses rich chlorophyll content and the cells contain starch grains in them. Probably the starch serves as nutrition, and we are led to infer therefore that the bacteria are constantly supplied with plenty of carbohydrate material as a source of energy for nitrogen fixation. Later on, liquefaction of the bacterial tissue could be clearly noticed, so that it is possible that the bacteria are actually digested by the plants.

ISOLATION.

Leaves that showed good nodule development were selected. They were cut into bits without disturbing the nodules. The bits were immersed in 0.1 per cent. mercuric chloride solution for 15 minutes so as to render the surfaces sterile. They were then thoroughly washed four times with sterile water, after which they were put into a sterilized petri dish with some sterile water and the nodules teased thoroughly by means of a sterile scalpel. The resulting cloudy emulsion was used as inoculum. One c.c. of the emulsion was put into different Erlenmeyer flasks containing nitrogen-free medium (mannite solution).

The same method was used for teasing the nodules on the leaves of *Pavetta indica* as well and one c.c. of the resulting liquid was made use of for purposes of inoculation.

All the inoculated flasks were incubated at 30°C. and observations made every 24 hours. On the fourth day a very thin light film made its appearance and from the fifth it was clearer. The film was slimy and its growth slow.

Sub-cultures were made by inoculating a loopful of this film into fresh flasks containing nitrogen-free mannite solution to as many as five generations, and from the fifth flask plating was done. The solid medium used for the purpose consisted of the following :—

Decoction of young leaves	500 c.c.
Water	500 c.c.
Gum arabic	20 gm.
Dicalcio phosphate	5 "
Agar	25 "
CaCO ₃ to neutralize			

The following liquid medium also recommended by Dr. Fabre was tried to see if better growth of the film was possible :—

Water	1,000 c.c.
Gum arabic	20 gm.
K ₂ HPO ₄	0.5 "
MgSO ₄	0.01 "
CaCO ₃	0.50 "
NaCl	Trace.
FeSO ₄	"

The growth of the film was almost similar to that observed previously in the mannite solution flasks. Therefore Ashby's mannite solution was taken in later experiments whenever fresh specimens of leaves, leaf-buds, flowers and seeds had to be tried for the presence of bacteria, and in all cases good growth of the film was noticeable.

COLONY CHARACTERISTICS.

The colonies develop slowly on the solid medium described above and are extremely small and of gummy consistency.

They make their appearance five days after plating. Ten days later they are better developed and appear milky white and opalescent. They form thin round colonies.

The colonies are 3-4 mm. in diameter. It has been possible to observe better growth of the colonies by plating a second time from the colonies in previous plates.

In plates where very few colonies were allowed to develop by dilution methods the colonies were observed to be even 10 and 11 mm. in diameter. These well-developed colonies look white and shining.

In the case of *Pavetta indica*, almost the same appearance was observed but the colonies looked milky white with concentric circles, their margins being sharply and regularly defined. The brownish concentric circles round each colony seem to be very characteristic of *Pavetta indica* colonies. Slants of the above solid medium were inoculated and growth observed every 24 hours. Slides were prepared from these slants and examined after staining.

The organisms stain well with the usual stains but best with Amyl gram stain and are typical rods.

It was observed in previous mannite flasks that there was still some sugar left unused and consequently fresh inoculations from leaf-nodules were made in duplicates and incubation period extended to five weeks. The following table shows the

amounts of nitrogen fixed after deducting the nitrogen in the controls.

			Mg. nitrogen fixed during five weeks in mannite solution containing 2 gm. mannite after deducting the nitrogen from the control flasks	Mg. nitrogen per gm. mannite consumed
1. <i>Chomelia asiatica</i>	$\left. \begin{array}{l} 22.40 \\ 21.98 \end{array} \right\} 22.19$	11.095
2. <i>Pavetta indica</i>	..	.	$\left. \begin{array}{l} 31.85 \\ 32.13 \end{array} \right\} 31.99$	15.995

These figures, namely, 11.095 and 15.995 mg. per gm. of carbohydrate consumed, are a sufficient indication of the activity of the organisms. These results compare very favourably with the observations of Fabre and Miehé.

Bacteria are observed to be extremely active at the vegetative points. They appear to concentrate at growing tips as the plant develops. It is always best to use young bacterial nodules or leaf-buds to culture the organisms. It has been found that they prefer an alkaline medium. There was practically no growth on gelatine but on nutrient agar a slight growth was noticeable. The organisms seem to require plenty of air and it has been observed that light scratching with the platinum needle of the culture on the surface of the medium has given much better growth than the usual method of plating. In thin layers of the liquid medium contained in similar flasks, the organisms fix more nitrogen than in deeper layers, thus showing that they want plenty of air.

Pure cultures grow extremely slowly in their culture media. In pure cultures the bacteria produce acid from the liquid medium described above. They are sometimes irregular in shape and curved forms are to be seen at later stages and a detailed study of the organisms is being made.

EXAMINATION OF SEEDS.

Between the embryo and the endosperm, one can find the bacteria. Even in the case of embryo, the embryo plant appears

to contain bacteria at the vegetative point in the seeds of both the species examined. As the seeds germinate the embryo plants show bacteria in their growing points. Thus what is termed hereditary symbiosis seems to exist in the case of *Chomelia asiatica*, that of *Pavetta indica* having been already announced by Fabre.

When some of the seeds are teased and inoculated into mannite solution there is fermentation of sugar as evidenced by bubbles of gas. There is also fixation of nitrogen. It is thus evident that bacteria are always present in the seeds. Similar experiments were tried with leaf-buds, stipular regions and flowers (ovaries), and bacterial film made its appearance on the surface of the nutrient solution in all the flasks that were inoculated. Both Fabre and Mische have conclusively proved that the relationship between the bacteria and the plants they examined seems to be mutually beneficial and that the plants are unable to thrive without the bacteria which were shown to be always present throughout the life-history of the plants. It is yet to be seen if nodular formation could be induced by means of inoculating the pure cultures of bacteria into seedlings grown from bacteria-free seeds.

In order to get plants free from bacteria von Fabre treated the seeds in hot water at 50°C. for 25 minutes and has observed that the resulting plants showed nitrogen hunger. The leaves were pale and the plants looked stunted and sickly, whereas the bacteria-containing plants grew normally and looked quite healthy with dark green foliage and larger development of all the parts of the plants. Pot culture experiments are in progress to ascertain definitely whether the bacteria are necessary for the plants to thrive in the case of *Chomelia asiatica* as well. For this purpose some seeds were heated at 55°C. for 30 minutes so as to kill the bacteria but not to affect the embryo. They have been sown in pots. Some seeds without any such hot water treatment are also sown and observations are being made.

It was already shown that bacteria enter the leaf through the stomata which close afterwards and thus imprison the guests. These bacteria abstract the nitrogen from the air-cells in the leaf and utilize the same for building up their bodies. This

implies that large numbers of bacteria should be present if the nitrogen supply in the leaf is to increase. We know, however, that, in the course of development, the plant absorbs the bacterial matter which thus increases the percentage of nitrogen in the leaves and other parts of the plants. Therefore parts of plants such as leaves and twigs in which large numbers of bacteria are present must necessarily contain a large percentage of nitrogen. To an agriculturist desirous of improving the soil fertility either permanently or for the benefit of a single crop, the application of the leaves and tender portions of such plants becomes one of prime importance. Plants vary in their nitrogen content and their relative value also consequently varies. The amount of nitrogen assimilated by the respective bacteria is given in the following table:—

No.	Kind of plant	Period of incubation given in number of days	MILLIGRAMS NITROGEN FIXED	
			Per 100 c.c. mannite solution with 2 grm. mannite	Per grm. of mannite consumed
1	<i>Chomelia asiatica</i> }	21	12.85	6.425
		21	12.45	6.225
		35	22.49	11.245
2	<i>Pavetta indica</i> }	21	16.89	8.445
		21	17.15	8.575
		35	31.85	15.925

The figures in the above table are given after deducting the nitrogen in the controls, and the table shows clearly that the assimilation of atmospheric nitrogen is very intensive. The discovery regarding the functions of bacteria inhabiting the root nodules of legumes has had a marked influence on the question of maintaining soil fertility, and the author considers that it is only a question of time for people sufficiently to realize the importance of the functions of the bacteria inhabiting the leaf-nodules of some

of our Indian plants. The more remarkable feature of these leaf-nodule organisms is that they are found at all stages in the life-history of the plants. The relationship is of a hereditary nature, thus making it absolutely clear that the symbiosis has been developed to a far greater extent than in the case of legumes.

It is well known that certain crops (paddy, sugarcane, coffee, tea, etc.) require large quantities of nitrogen for their growth and do not contain as much nitrogen as pulses. Consequently they need large applications of leaves of such plants as *pungam* (*Pongamia glabra*), *tangedu* (*Cassia auriculata*) and others to supply the nitrogen needed. It is a very common practice among cultivators in South India to apply cart-loads of leaves of particular trees and not any leaf they come across at random.

They can be used as a source of organic matter and of plant food, as a bedding for farm animals and can be applied to soils in green houses after composting.

Their value lies in the fact that their nitrogen content, weight for weight, is greater than that of most other leaves.

They also improve the physical properties of the soil such as water-holding capacity, capillarity and soil texture in the same manner as any other green manure.

From the foregoing it is evident that the leaves of (1) *Chomelia asiatica* and (2) *Pavetta indica* can be made use of as green-leaf manures with advantage, wherever possible. Their chief merit lies in being available in large quantities from self-sown jungle trees growing in almost all the districts of the Presidency. It is a noteworthy fact that among the Tamil cultivators of Ceylon (northern districts) these leaves are in high esteem as green-leaf manures.

SUMMARY AND CONCLUSIONS.

1. Symbiotic nitrogen fixation is not restricted to Leguminosæ alone but is a widespread phenomenon.

2. Plants of other Orders such as Rubiaceæ, Myrsinaceæ and Casuarinaceæ are instances of the above phenomenon in the tropics, and in temperate regions several others have been enumerated as examples.

3. *Chomelia asiatica* has now been given in this paper as a further instance of the same phenomenon.

4. The nodules on the leaves of *Chomelia asiatica* are caused by bacteria which are found filling the nodules.

5. These bacteria are capable of fixing atmospheric nitrogen.

6. They are found at all the stages in the life-history of the plants.

7. The symbiosis is developed to a far greater extent than in Leguminosæ and is of a hereditary character.

8. The plants are unable to grow in the absence of bacteria.

9. The nitrogen fixation noted compares very favourably with that noted by previous workers.

10. Of the bacteria, the typical forms are rod-shaped while of the later stages forked and curved forms are also to be seen. They are found to be strongly aerobic.

11. Leaves and tender portions of plants investigated can be used with profit as green-leaf manures.

12. Besides the addition of so much extra plant-food to the soil, the leaves improve the physical condition of the soil as well.

It will be satisfaction enough for me if this preliminary paper has shown what a wide field there is for further work in tapping new sources of manure supply and to what extent the ryot can be benefited in his crying need for cheap manures.

My thanks are due to the Government Agricultural Bacteriologist for facilities afforded for conducting the above investigation, and many forest officers for material.

A USEFUL PLANT FOR INDIA.

BY

K. KUNHIKANNAN, M.A., PH.D., F.E.S.,
Of the Department of Agriculture, Mysore.

WHILE engaged in research work at the Stanford University, California, I had to look up references regarding a tree commonly known as Mesquite or Algaroba and was so impressed with its usefulness that I decided to take seeds with me to India. The tree is a native of Brazil but is either indigenous or cultivated in Argentine, Chile, Peru, Bolivia, Columbia, Central America, Mexico, Texas and the West Indies.

In Hawaii, where I had opportunities of observing the habits of the tree, it was introduced by a missionary in 1828. Since then it has spread over the islands, and now occupies in Oahu alone no less than 100,000 acres. The tree is, however, confined to the leeward portions of the island where it thrives from the sea coast up to an altitude of 2,000 ft. In this part of the islands rainfall is scanty and in places so little that the localities may be little different from semi-arid desert. The windward side of the islands have, however, a different climate owing to the trade winds which blow practically throughout the year. Rainfall varies from 200 to 400 inches. Here the tree is but rarely found.

The Mesquite is a legume belonging to the Genus *Prosopis* which is represented by but two species in India. The following is the scientific description of the plant *Prosopis juliflora* :—

“ A tree 10 to 20 m. tall, branches glabrous or minutely puberulous ; stipules small setaceous or aristate, sometimes obsolete ; spines axillary, solitary or in pairs, straight, in sterile branches up to 5 cm. long, divaricate, sometimes very short or entirely absent ; leaves glabrous or rarely pubescent, distant or in short branchlets, subfasciculate, common petiole 12 to 50 mm. ; glands often small between the pinnæ, and smaller between leaflets ; pinnæ often 1-jugate, rarely 2-jugate, very rarely 3-jugate ; rachis 3.25 to

7.5 cm. ; leaflets broadly oblong 4 to 6 mm. long, or linear 12 mm. to 2.5 cm. long, with intermediate forms straight or falcate, obtuse or pointed, the costa somewhat prominent beneath ; inflorescence spicate, axillary, or fasciculate with the leaves, shortly pedunculate, 5 to 10 cm. long, dense or slender and subinterrupted ; bracts minute, flowers glabrous outside or with few short scattered hair, 3 mm. long, calyx 1 mm. long, the opening often ciliate, petals are often woolly inside at the apex ; stamens half as long again as the corolla ; ovary shortly stipitate, villose ; pod more or less arcuate or nearly straight, 5 to 15 cm. long, 4 to 12 mm. wide, before maturity often flat compressed, at maturity on both sides more or less convex, continuous outside, or between the seeds marked with depressions of transverse lines, mesocarp more or less spongiose, endocarp hard, often bony."

The tree is very variable. In Texas it is little more than a shrub but further south in Mexico it grows into a large tree often attaining a height of 45 to 50 ft. with a diameter of about 2 ft. The roots go down to great depths after water. This latter feature makes it specially adapted for growth in regions with scanty rainfall.

The flowers have a sweet scent and the flower spikes are from 4 inches to 6 inches long. There are two flowering seasons, one in April and the other about October. The pods are from 6 to 10 inches long and have a thick spongy pericarp containing syrupy matter. They turn yellow when ripe and drop to the ground. They are of high nutritive value and much relished by all kinds of stock. Children in Texas also eat them. The pods are collected and ground to serve better as cattle food. The crop in the island of Oahu alone is estimated at 25,000 tons annually and a factory has been established there to deal with this enormous output.

The value of the tree does not consist in the pod alone. The long flower spikes yield honey in abundance and in some parts of Texas and Hawaii this is the only source of honey for the large number of beehives kept. They produce an abundance of pollen. Out of the 600 tons of honey produced in Hawaii about 200 tons are derived from Mesquite alone. A tree of about 30 ft. spread is estimated to produce 2½ pounds of honey.

One advantage the tree has over most other honey-producing trees is that it blossoms twice in the year, once about April and

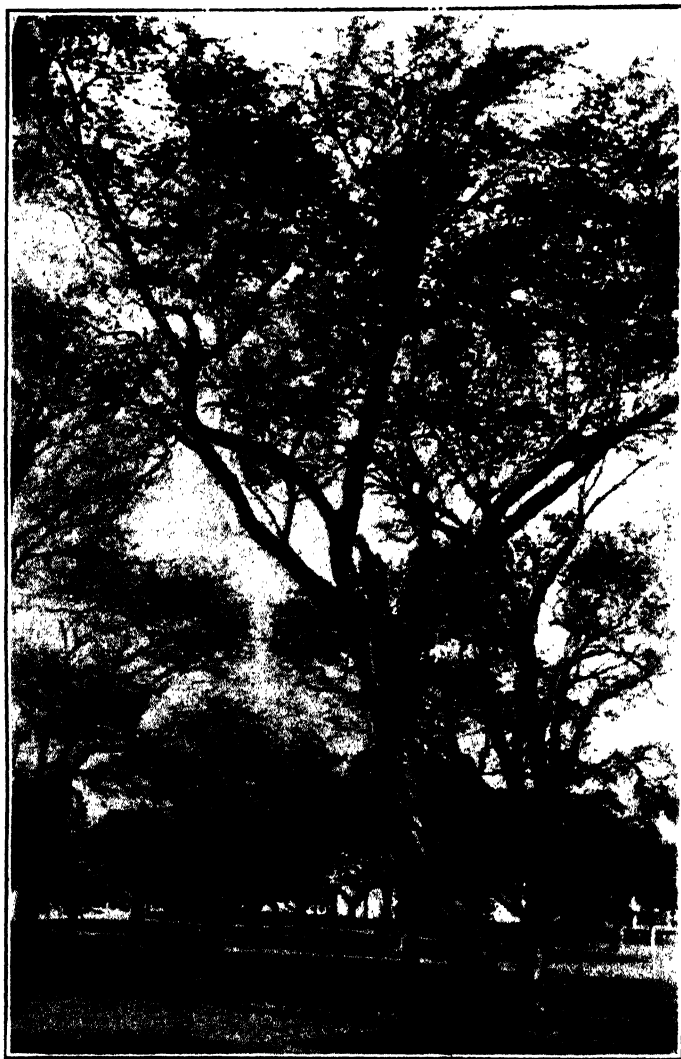

Mesquite or Algaroba.

again in October. The April blossoms last till August so that save for a short period of about two months there are flowers nearly the whole year. A fairly continuous supply of honey is assured to bees. A second feature is that, provided there has been rain in the latter part of the year, there will be an abundance of flowers the next year no matter how dry the following summer is.

When grown to its full height the Mesquite is a very graceful tree and serves well as an ornamental tree in parks. The illustration is from a park in Honolulu. The wood takes a fine polish and is therefore used for furniture and cabinet work.

From the description given above, the value of the tree to India is obvious. Provided it can be naturalized—and there can be no doubt from the wide range of its habitat that it can be—it will go far to solve the problem of cattle famine. The large yield of pods averaging to 200 to 300 lb. will provide a source of highly nutritive food especially in localities where from want of rain the cattle are liable to starvation. The adaptability to semi-arid regions makes it specially valuable. There are large tracts in India of this description where the tree may usefully replace other trees now growing wild or grown solely for firewood.

The Mesquite is equally important as a source of honey. One great obstacle to extensive bee-keeping in India is the scarcity of honey-yielding plants in the plains. As a result indigenous bee-keeping has been confined to the hilly tracts where the drawback does not exist. With the introduction of Mesquite there will be provided a continuous source of honey for the greater part of the year.

A large number of seedlings have been raised in Bangalore from the seeds brought down from Hawaii. They seem to thrive well but their behaviour in their new home is yet too early to forecast. The tree is very variable as has been mentioned already. It is possible that it will exhibit the same variation in India as it has in other parts of the world. But whatever the variation, its great value as a source of highly nutritive cattle food is not likely to be diminished under the different conditions of this country.

Note.—Since the acceptance of the article for the Journal, I have been informed by Rao Bahadur Rangachari, Lecturing Botanist at the Agricultural College, Coimbatore, that he saw several of these trees fairly full grown in a sandy tract near Madras and the appearance showed that they were thriving well. The possibility has occurred to me, therefore, of the introduction of the plant in other localities in India, more especially in parks and botanical gardens. If my surmise is correct, there is already valuable experience available of the behaviour of the tree under Indian conditions, and I trust those who have it will make it known to the public through the medium of the Journal. [K. K.]

A PRELIMINARY NOTE ON THE THEORY OF
PHOSPHATIC DEPLETION IN THE SOILS
OF BIHAR.*

BY

ALBERT HOWARD, C.I.E., M.A.,
Imperial Economic Botanist ;

AND

GABRIELLE L. C. HOWARD, M.A.,
Second Imperial Economic Botanist.

ON several occasions during recent years, the idea has been advanced that the calcareous soils of North Bihar are deficient in available phosphate. It has also been suggested that this is the cause of the wilt disease of indigo in this locality. The remedy proposed is systematic manuring with superphosphate of lime. The results obtained in the field are, however, exceedingly erratic. Sometimes a positive result is obtained, often the effect is negative. In a letter published in the *Journal of the Royal Society of Arts* (Vol. LXVII, 1919, pp. 762-764), we indicated the general nature of our results on the causes of the wilt disease of indigo and advanced a number of reasons which had caused us to reject this depletion theory as being responsible for indigo wilt. The full details of this work are to be found in the *Memoirs of the Department of Agriculture in India (Botanical Series)*, Vol. XI, No. 1, 1920.

The scientific basis of the depletion theory at first rested on the very low results obtained when these soils are tested for available

* A paper read before the 1923 meeting of the Agricultural Section of the Indian Science Congress.

phosphate by Dyer's citric acid method. The cause of these low figures has since been explained by Jatindra Nath Sen¹ and by Harrison and Surendralal Das² who showed that this method of analysis is bound to give low results when large quantities of carbonate of lime are present. Harrison and Surendralal Das also observed that soluble superphosphate rapidly reverts to di-calcic phosphate, CaHPO_4 , and then to insoluble tri-calcic phosphate, $\text{Ca}_3(\text{PO}_4)_2$, when added to Pusa soils. The reaction can be represented by the following equations :—

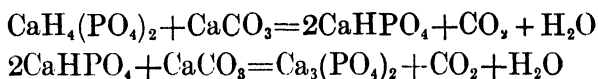

The phosphate depletion theory has therefore little or no analytical basis. It now rests solely on the results obtained in the field which are by no means constant. In one direction, however, positive results are being obtained. On rather heavy soils or when the surface drainage is defective, applications of superphosphate in connection with green manuring with *sanai* (*Crotalaria juncea* L.) increase the efficiency of the process.

During the last few years we have been conducting experiments at Pusa with the object of clearing up some of the remaining difficulties connected with this depletion theory. Interesting preliminary results have been obtained which appear to suggest that the explanation of the erratic results obtained with superphosphate as well as those in connection with phosphate and green manuring might be due to the effect of the superphosphate on the physical texture of the soil as suggested in our letter on this subject published in 1919. These experiments fall into four groups :

1. *Continuous indigo plot.* Since June 1919, indigo has been grown continuously in the same soil in a lysimeter (one-thousandth of an acre in area and four feet deep) provided with free drainage below. No superphosphate or any substance containing phosphorus

¹ *Agri. Jour. of India*, XII, 258, 1917.

² *Mem. of the Dept. of Agri. in India (Chemical Series)*, V, 195, 1921.

has been added to the soil. The indigo is cut in the ordinary way, the crop is removed and the roots are picked out when the plot is resown every October. There is practically no fallow. Four crops have been removed and the fifth, sown in October 1922, is doing well. If the soil of Bihar is really deficient in phosphate, there ought to have been a rapid falling off in growth. No such result has yet been obtained. The third cut, taken on September 27th, 1922, in a year of heavy rainfall (over 60 inches) when the indigo crop in Bihar did very badly after July, is shown in Plate III. In this year, the third cut weighed as much as the first, namely, 5 seers 12 chittaks (5,364 grammes). Two other results of great interest were, however, observed. The first of these relates to the physical texture of the soil. At the end of the monsoon of 1921, it was noticed that the permeability was beginning to fall off and the drainage was becoming defective. The pore spaces near the surface were seen to be suffused with water and the soil refused to drain. It became jelly-like, due probably to the formation of colloids. This condition disappeared when the soil was removed and put back again before the indigo was resown in October of that year. The permeability became gradually worse during the heavy rains of 1922 and in August last, the plants began to turn yellow and appeared to be short of nitrogen. Nitrogen was added in the form of sulphate of ammonia at five maunds to the acre and *gur* (sugar) was mixed with the surface soil to promote nitrogen fixation. There was an immediate response. The last indigo cut of 1922 was a very good one. In this experiment, the first deficiency noted was loss of permeability, the second want of nitrogen. No evidence of arrest of growth due to lack of phosphate has been observed. The experiment is being continued.

2. *The effect of reducing the amount of total phosphate.* When grown in pit cultures with Pusa soil mixed with one-third its volume of inert material (potsherds), Java indigo grew faster than the control (ordinary Pusa soil) and gave much more seed. Here reducing the total amount of phosphate and improving the aeration increased the vegetative growth by over 30 per cent. (Table I).

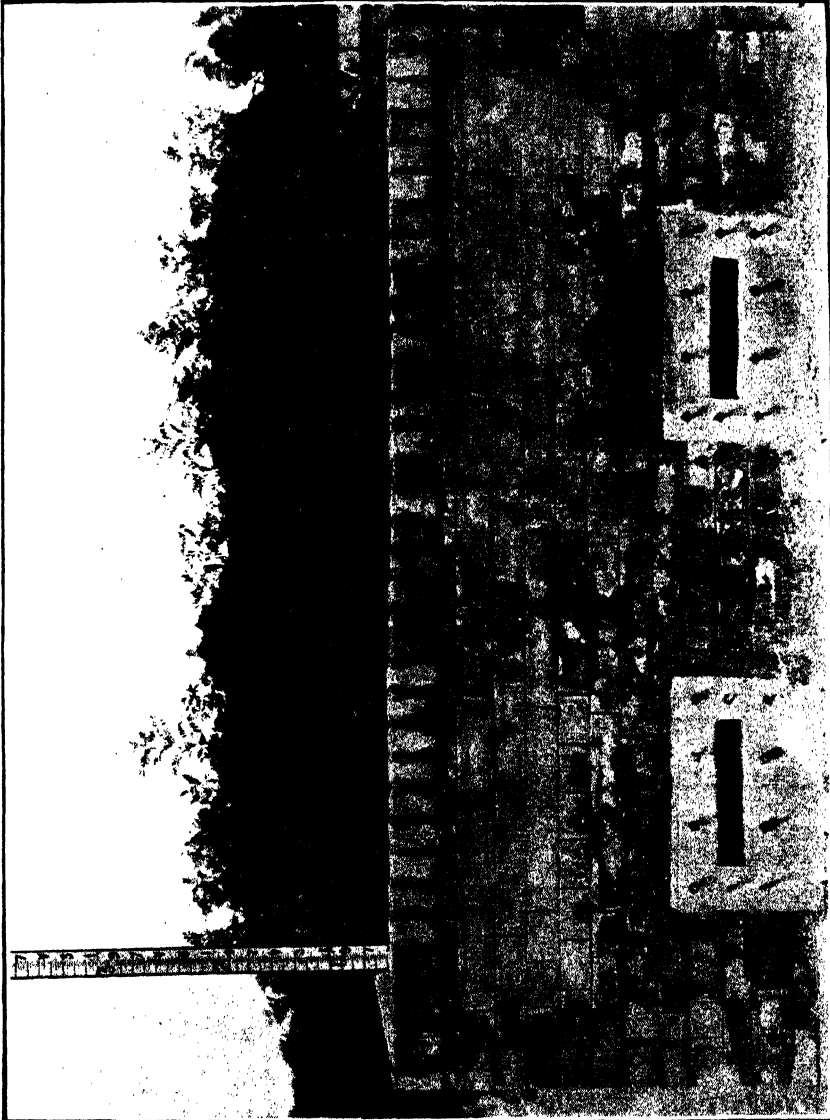

THE CONTINUOUS GROWTH OF JAVA INDIGO IN THE SAME SOIL AT PUSA.

(The photograph shows the third cut of the fourth crop.)

TABLE I.

The effect of improved soil aeration on the growth of indigo.

Kind of soil			No. of plants measured	Average length in cm.	Percentage increase
Soil only	33	36.7	..
50% soil + 50% sand	36	51.6	40
90% soil + 10% potsherds	33	48.3	31
70% soil + 30% potsherds	35	50.9	38

The effect on seed formation was even greater (Table II).

TABLE II.

The effect of soil aeration on the seed production of Java indigo.

Soil treatment	No. of plants	AVERAGE HEIGHTS OF PLANTS IN CM.											Weight of dry produce in grammes corrected for 50 plants.	
		Oct. 10	Oct. 23	Nov. 3	Nov. 13	Nov. 23	Dec. 3	Dec. 13	Dec. 23	Jan. 2	Feb. 1	Feb. 21	Stems excluding leaves	Seed
		Control	49	4.4	7.7	11.9	15.5	20.3	24.5	25.9	25.8	26.7	28.1	27.2
Soil $\frac{1}{2}$ + sand $\frac{1}{2}$	50	4.3	6.9	11.5	17.4	23.7	28.9	31.6	33.5	34.1	35.6	35.0	127	70
Soil $\frac{7}{10}$ + potsherds $\frac{3}{10}$	50	4.5	9.2	14.5	19.9	26.6	30.6	33.0	33.9	34.7	34.6	33.5	136	89
Soil $\frac{8}{10}$ + potsherds $\frac{2}{10}$	50	5.2	8.4	13.4	18.1	23.6	28.6	30.4	32.1	32.9	33.6	33.6	141	94
Soil $\frac{9}{10}$ + potsherds $\frac{1}{10}$	49	4.4	7.7	12.5	17.1	22.8	27.4	28.8	30.3	32.4	32.4	31.1	118	92
Control	48	3.8	6.2	9.4	12.3	16.1	19.1	21.0	21.3	23.3	24.3	24.4	72	32

3. *The effect of increased available phosphate on growth.* This has been investigated by growing indigo in two sets of lysimeters—one filled with alluvial soil from Kalianpur and the other with Pusa soil. Kalianpur soil is exceedingly rich in available phosphate (0·318 per cent.) while Pusa soil, when analysed by Dyer's method, gives very low figures (0·001 per cent.) of available phosphate. In spite of this the growth has always been greater in Pusa soil than in Kalianpur soil as the measurements in Table III show.

TABLE III.

The effect of available phosphate on the growth of indigo.

	AVERAGE HEIGHT IN INCHES	
	September 11, 1918	September 15, 1919
Pusa soil	10·7	36·4
Kalianpur soil	5·0	20·1

These figures do not support the view that manuring with superphosphate will necessarily increase the growth of Java indigo.

4. *The effect of superphosphate on the physical texture of the soil.* In our letter of August 25th, 1919, published in the *Journal of the Royal Society of Arts*, we stated "Superphosphate when applied with green manure in Bihar produces its greatest effect on soils the surface drainage of which is poor and whose texture has been affected by heavy rain. There is reason to believe that the result has nothing to do with the addition of phosphate at all but is due to an alteration in the physical texture of the soil brought about by some constituent of the manure." We have just completed some preliminary experiments on this point, the results of which are of considerable interest. As has been pointed out above, superphosphate reverts to the insoluble condition when added to Pusa soil. It acts as a weak acid in the presence of finely divided calcium carbonate until the reversion is complete. It is possible that this reaction in itself may have some influence on the soil

colloids and may be the reason why superphosphate helps to make green manuring more efficient. Our results¹ clearly prove that the effect of green manure on the succeeding crop at Pusa always increases as the soil aeration improves. If superphosphate merely alters the physical condition of the soil and helps aeration, other substances which act as weak acids ought to have a similar effect. We have so far compared the results obtained with very dilute sulphuric acid, sulphur and superphosphate on cotton (a plant very sensitive to poor soil aeration) when grown in Pusa soil in lysimeters provided with free drainage. The 1922 results are given in Table IV.

TABLE IV.

The effect of "dilute acids" on the growth of cotton.

	Average height of 20 plants in cm.	Weight of green plants in grammes	REMARKS
Superphosphate	49.1	855	} Manures added at the rate of one maund per acre.
Flowers of sulphur	65.7	1,653	
Dilute sulphuric acid ..	58.9	1,453	

It will be seen that sulphur and sulphuric acid have given a better result than superphosphate. The best result has been obtained with sulphur. One possible explanation is that we are dealing with a physical effect. Sulphur appears to be slowly oxidized and its action would be more continuous than in the case of substances like superphosphate and sulphuric acid which are soluble in water and which react with calcium carbonate with great rapidity. Another explanation of these results is that the small amount of phosphate present in Bihar soils is brought into solution by dilute acids and thus rendered more available. If this is so, indigo grown continuously in the same soil in a lysimeter and manured every year with sulphur will very rapidly exhibit signs of phosphate starvation.

¹ *Agri. Jour. of India*, XI, 1916, Special Indian Science Congress Number, p. 46.

The next step will be to compare the yields obtained in the field with equivalent amounts of superphosphate, sulphur¹, sulphuric acid and similar substances applied in connection with green manuring and also directly for crops like turnips, swedes and rape which often respond to superphosphate. If small dressings of sulphur prove of use in India in increasing the efficiency of green manuring and in improving the yield of oil seeds of the *Brassica* family, this substance will not only materially help in the solution of the nitrogen problem but will also prove of value in the increased production of a group of important revenue producing crops. The indirect effect of artificial manures and other chemicals on the soil is a subject which requires more investigation all over the world. It has been almost completely neglected in India.

¹ The application of 10 to 40 lb. of sulphur to the acre has been tried at Ranchi where A. C. Dobbs found that both groundnuts and rape benefited greatly by the application. (*Agri. Jour. of India*, XI, 1916, pp. 310-311.) No experiments are quoted on the effect of sulphur on green manuring and no explanation of the action of sulphur is given in this paper.

Selected Articles

PROOF OF THE POWER OF THE WHEAT PLANT TO FIX ATMOSPHERIC NITROGEN.*

BY

C. B. LIPMAN AND J. K. TAYLOR.

IN a series of wheat cultures in solutions, we have recently proved conclusively that wheat plants, even in only six weeks of growth, can fix large quantities of nitrogen from the air. They possess this power whether nitrogen is supplied to the roots or not.

Seventeen years ago, Jamieson¹ made the startling announcement, based on experiments, that all green plants possess the power of fixing atmospheric nitrogen. He supplemented this announcement by another to the effect that special organs exist on the young leaves of plants whose function it is to fix the air nitrogen and he called these organs "albumen generators." This supplement to Jamieson's first announcement and the somewhat loose statement of his proffered evidence on the nitrogen fixation, coupled with the indelible impression of Lawes and Gilbert's and Boussignault's experiments and conclusions, caused the scientific world as a whole to scout or ignore Jamieson's evidence and the earlier contentions of Ville and a few others to the same effect. In 1911, Mameli and Pollacci² published a statement of experimental results which were not subject to the criticisms pertinent in Jamieson's case and which proved conclusively that a variety of green plants possess the power of fixing atmospheric nitrogen. Later statements by them³ only confirmed their earlier assertions. They did not

* Reprinted from *Science*, Vol. LVI, No. 1456.

¹ *Report of Agri. Res. Assn.*, Aberdeen, 1905, et seq.

² *Atti dell' Istituto Botanico della R. Università de Paria*, Vol. 13, p. 351.

³ *Ib.*, Vol. 14, p. 159, and Vol. 16, p. 197.

accept Jamieson's supplementary statement relative to the mechanism of the fixation in question.

Even the world of science is so conservative as not to have caused a general acceptance of the contentions of Jamieson and Mameli and Pollacci, despite the fact that Moore and Webster¹ and Moore, Webster and Whitley,² as well as Wann,³ have more recently furnished ample confirmatory evidence with fresh water and marine algæ as material. In order to furnish further evidence for securing an acceptance of this new view of nitrogen fixation which is directly opposed to the old established view and to obtain data for the wheat plant which has not been studied in that regard, the writers have recently carried out an experiment resulting as indicated in the general conclusion introducing this brief note. Wheat plants were grown in "Shive's best" solution of an osmotic pressure of 1.3 atmospheres. These solutions were so constituted as to have approximately the same concentration throughout, regardless of whether or not nitrogen was present. The containers for the solution were quart Mason fruit jars and the usual technique was employed. Five wheat seedlings per jar, and six jars of each kind of solution were employed, thus testing thirty plants with each solution. In the case of the solution containing no nitrogen, twelve jars were employed, six of them being kept in the greenhouse until seeds were formed. All the other plants were grown for a period of six weeks only. It is impossible now to go into the many interesting features of this and other experiments which we are conducting on the important subject of nitrogen fixation. Suffice it to say that in a number of series of wheat plants grown without nitrogen and with varying quantities of nitrate, definite evidence was adduced that all the wheat plants fix nitrogen from the air. Even excluding the nitrogen content of the culture solutions at the end of the experiment, because of some irregular data in the analyses, there is a gain of nitrogen from the air which varies in different series from 13 to 21 per cent. of the total amount of nitrogen found in the

¹ *Proc. Roy. Soc. Lond.*, Series B, Vol. 91, p. 201 (1920).

² *Ib.*, Vol. 92, p. 51 (1921).

³ *Amer. Jour. Bot.*, Vol. 8, pp. 1-29, January, 1921.

plant. With the nitrogen in the solutions taken into account, these values will be much larger.

A series of experiments with barley is now being completed, and promises to yield similar results to those obtained with wheat. Legumes and other plants will now be studied, and many other features of the subject investigated. There can be no question now, however, that the teaching of all our books, and nearly all our teachers on the subject to-day are erroneous and must be changed completely to accord with the facts presented by us, and by the other investigators whom we have cited above. As Moore and Webster have put it, authority has too long held sway over logic and experimental fact. It is high time to let those considerations rule. A full, theoretical and historical discussion of this problem will be given in the detailed account of our experiments.

NITROGEN FIXATION IN ARID CLIMATES.*

BY

B. H. WILSDON, B.A., I.E.S.,

AND

BARKAT ALI,

Punjab Agricultural College.

IN a country such as the Punjab, the soil receives very small applications of manure. It is estimated that, in a typical irrigated colony tract, the land receives on the average not more than between one-half to one ton of farmyard manure each year. In non-irrigated tracts (so called *barani* land) it may be taken that no manure is added to the soil since any manure available is applied to well irrigated land in the neighbourhood. In some tracts it has been the custom to grow wheat after wheat with no application of manure at all. The economic conditions and the conservatism of the peasantry make any general use of commercial organic manures, such as cake, a remote possibility for a long time to come. Any possibility of bringing under control the factors which determine the natural processes of nitrogen fixation, which must be taking place in the soil, is therefore of enormous importance.

That the natural recuperative powers of soils in arid regions must be considerably greater than those met with in more temperate climates is shown by crop yields obtained when moisture conditions are favourable. Yields of wheat, which would certainly not be expected from a similar soil in a temperate region, are obtained on what would be regarded, from its history, as totally exhausted land. It would seem justifiable to suppose therefore that the climate may have a large influence on the activity of free-living

* Reprinted from *Soil Science*, XIV, No. 2.

nitrogen-fixing organisms. Moreover, it is possible that the frequent cultivation, which the tradition of the peasant leads him to give his soils during the hot-weather fallow between his wheat crops, may not only conserve moisture but also bring about suitable conditions for active nitrogen fixation.

There can be no doubt that in *barani* tracts agriculture is almost wholly dependent on the natural processes of nitrogen fixation; that these processes are of almost equal importance under the better conditions of agriculture possible in irrigated tracts may be seen from the following considerations. Table I gives the area under various crops in the Lower Chenab Canal colony, together with a conservative estimate of their average yield. The amount of nitrogen in the total produce is then calculated, largely on the basis of the analyses of Sen.¹ This figure shows, on comparison with the average application of farmyard manure, that artificial sources can only account at most for about one-sixth of the total produce. Otherwise expressed, natural processes of fixation add something in the neighbourhood of 38 pounds of combined nitrogen per acre per year.

TABLE I.

Estimate of average annual loss of nitrogen by cropping.

CROP	AREA SOWN	YIELD PER ACRE		TOTAL NITROGEN CONTENT		TOTAL NITROGEN CONTENT OF CROP	
		Grain	Straw	Grain	Straw	Grain	Straw
	acres	maunds*	maunds	per cent.	per cent.	maunds	maunds
Wheat	986,591	16	35	1.50	0.5	236,800	172,700
Barley	17,751	12	20	1.49	0.6	3,175	2,130
Rice	32,075	20	30	1.01	0.6	6,480	5,774
Maize	103,197	22	60	1.34	2.0	30,420	123,836
Mixed grain ..	10,509	23	35	2.68	0.7	6,479	2,575
Great Millet (<i>Jowar</i>) ..	18,071	8	60	1.40	0.6	1,800	5,785
Spiked Millet (<i>Bajra</i>) ..	35,092	9	60	1.86	4.7	5,874	98,960
Italian Millet (<i>Kangni</i>) ..	377	8	20	1.91	1.8	57	135

¹ Sen, J. N. "The composition of some Indian feeding stuffs." *Pusa Agri. Res. Inst. Bull.* 70, 1917.

* One maund = about 82 lb.

TABLE I.—*concl'd.*

CROP	AREA SOWN	YIELD PER ACRE		TOTAL NITROGEN CONTENT		TOTAL NITROGEN CONTENT OF CROP	
		Grain	Straw	Grain	Straw	Grain	Straw
	acres	maunds*	maunds	per cent.	per cent.	maunds	maunds
Gram	55,578	12	30	3.06	0.7	20,490	11,671
Lentils, etc.	6,317	8	15	3.94	0.8	1,991	748
Cotton	315,067	5	60	2.82	0.5	44,430	94,520
Til (Sesamum)	777	10	30	3.62	0.5	281	116
Sarson, Toria (Brassica Campestris)	236,045	7	25	3.30	2.6	54,540	135,400
Linseed	1,200	6	8	3.19	0.5	229	48
Sugarcane	59,443	300	..	0.19	..	33,890	..
Fodder	378,607	200	..	0.8 (Dry)	..	181,731	..
TOTALS	2,258,328					633,667	672,407

Total nitrogen removed	maunds	1,306,074
Nitrogen added as manure, estimated at 21 maunds of farmyard manure per acre analysing at 0.475 per cent. nitrogen		225,268
Difference equivalent to about 38 lb. nitrogen per acre		1,080,806

* One maund = about 82 lb.

TABLE II.

Nitrogen per 100 grammes in Lyallpur soils on dates shown.

DATE OF SAMPLING				Sandy loam	Loam	Clay loam
				Mg.	Mg.	Mg.
May 15, 1916	22.8	39.4	51.0
June 13, 1916	31.0	41.0	62.0
July 1, 1916	29.0	48.0	54.0
July 17, 1916	29.0	48.0	56.0
August 15, 1916	25.0	41.0	49.0
September 18, 1916	39.0	53.0	67.0
December 1, 1916	127.0	83.0	97.0

Land prepared and wheat sown

March 14, 1917	70.0	84.0	69.0
----------------------	----	----	----	------	------	------

Wheat growing; harvesting to be done after a month

In the year 1916 an extended series of field analyses were initiated at Lyallpur by the late J. H. Barnes¹. These were continued and supplemented with laboratory investigations by the present authors in succeeding years. In 1916 most remarkable results were obtained. The average fixation in four different districts of the Punjab amounted on the average to more than 100 per cent. of the total nitrogen in the soil. The possibility of any consistent error is precluded by the results of a more detailed examination of the soils of Lyallpur where the nitrogen content of the soil was estimated at frequent intervals between the wheat harvest in April and the date of sowing in the following November. The results are reproduced in Table II and plotted together with the rainfall in Figure 1. It will be seen that with all three soils examined, after a preliminary period of depression during the rains, rapid

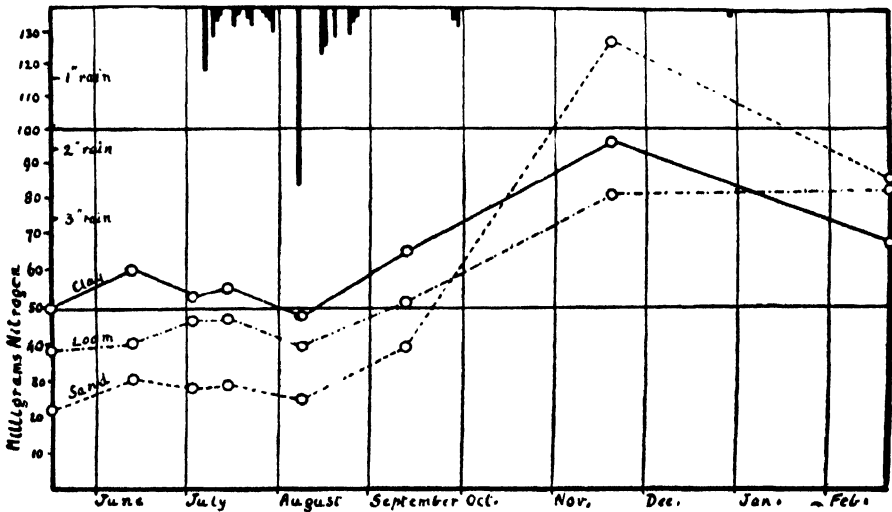

FIG. 1. Relation of rainfall and fluctuations in nitrogen content of Lyallpur soils.

increase took place during September and October. The astounding magnitude of the fixation may be realized by considering that an addition of 50 mg. of nitrogen per 100 gm. of soil (the average

¹ Wilsdon, B. H. "Nitrogen fixation in Punjab soils." *Ann. Rept. Agri. Dept., Punjab*, 1920, Pt 2, pp. 27-30.

fixation in 1916) corresponds with an application of about 150 tons of farmyard manure to the acre.

In 1917 experiments were continued on a smaller scale but failed to indicate any fixation. A more extended series of analyses were made in succeeding years, great attention being paid to accuracy of sampling, and the limits of the experimental error. The results will be found in detail in the Report of the Agricultural Chemist (*loc. cit.*) for 1918 and succeeding years, and can only be summarized here. As a result of a calculation of the probable field and laboratory errors it was decided to disregard as evidence of either fixation or de-nitrification any changes smaller than 8 per cent. of the total nitrogen content of the soil. The results of the large number of observations made are difficult to summarize concisely. The results are also extremely variable on account of differences of climate and cultivation. In Table III the soils have been divided into two classes, those in which the rainfall is above 10 inches and below 10 inches. These classes are again subdivided according to the treatment received by the soil. It will be seen that in no case during the succeeding years do the results approach in magnitude those obtained in 1916. Although isolated instances of considerable fixations occur, there is no uniformity. It is also impossible to correlate the detailed results with either rainfall, cultural, or temperature factors. By the collection of more evidence this may ultimately become possible; for the present we must recognize that peculiarly favourable conditions must have prevailed in 1916. One cannot help comparing the sudden activity of the nitrogen-fixing organisms in the soil of the Punjab with the increase of virulence of pathogenic organisms as in the case of the influenza epidemic of 1919. We are at present equally ignorant of the predisposing causes in both these cases.

In order to gain some insight into the factors controlling fixation in the field, in 1919 an elaborate series of laboratory experiments was started. The following hypotheses may be entertained:—

- (1) It may be assumed that if the great heat of the Punjab summer causes partial sterilization of the soil, when brought under optimum conditions, *azotobacter* will

have a better chance to develop rapidly in the absence of predatory protozoa.

- (2) *Azotobacter* alone may not be the determining factor; suitable conditions may be requisite for the development of another agent either previously to, or together with, the development of *azotobacter*. Thus it is well known that the presence of carbohydrate food is necessary for the functioning of *azotobacter*, and it has been suggested that a symbiotic relationship exists between it and species of *algæ* which develop in the soil.

In order to test these hypotheses, samples were taken at various dates throughout the fallow, which were then brought under, as far as possible, optimum conditions in the laboratory and the rate of change of nitrogen content determined. In order to test the possibility of partial sterilization in the field, the plots from which samples of the two types of soil examined were taken were duplicated, one receiving normal fallow treatment (cultivation after rain), the other being kept repeatedly stirred. The samples thus taken were brought to their optimum moisture content and incubated under three separate conditions until the following November. A sufficient number of separate samples of the main samples taken each month were set aside in order to provide the necessary duplicates for analysis each succeeding month. Of the three series of samples, one was incubated in the laboratory in diffused light, and another in a dark incubator. It was thought that any differences observed in the rate of nitrogen fixation in these two series might be due to the fact that *algæ* would be unable to develop in the dark. The third series was placed in large earthenware pots sunk flush with the ground out of doors, but protected from rain and dust by glass plates.

TABLE III.

Abstract of nitrogen-fixation results, expressed as percentages of original nitrogen contents of soil, and classified according to year, rainfall, cultivation.

(Figures with a negative sign prefixed represent losses in total nitrogen.)

CLASSIFICATION OF SOILS	1916			1917			1918			1919			1920							
	FIXATION OF NITROGEN		Number of observations	FIXATION OF NITROGEN		Number of observations	FIXATION OF NITROGEN		Number of observations	FIXATION OF NITROGEN		Number of observations	FIXATION OF NITROGEN		Number of observations					
	Highest	Lowest		Average	Highest		Lowest	Average		Highest	Lowest		Average							
Rainfall, 0-10 inches	per cent.	per cent.	per cent.	per cent.	per cent.	per cent.	per cent.	per cent.	per cent.	per cent.	per cent.	per cent.	per cent.	per cent.						
Cultivated	3	413.0	90.2	204.7	3	-36.4	-4.5	-23.2	22	21.4	-12.9	-0.3	10	9.7	-12.4	-0.3	6	8.7	-14.2	-2.8
Uncultivated	9	10.7	-8.6	0.7	5	9.5	-11.6	-1.1
Rainfall, 10-15 inches	per cent.	per cent.	per cent.	per cent.	per cent.	per cent.	per cent.	per cent.	per cent.	per cent.	per cent.	per cent.	per cent.	per cent.						
Cultivated	6	199.0	66.7	132.4	9	30.9	-21.8	* ± 0.0	6	3.4	-5.7	-1.1	7	13.1	-11.9	+0.2	1
Uncultivated

* Would seem to be 4.5 per cent.—ED.

The most direct method of testing the hypotheses would no doubt be to supplement experiments similar to those described above by enumeration of the number of azotobacter, protozoa and algæ. The technical difficulties involved are however very great, so it was decided in the preliminary experiments to rely solely on the chemical evidence. Qualitative results were obtained as to the prevalence of protozoa, but the evidence was not sufficiently reliable to enable any conclusions to be based on it. It is hoped that this aspect of the work will be developed in the future.

The largest fixation observed was not more than 45 per cent., showing that we had not been successful in reproducing the favourable conditions of 1916. The results were, moreover, very variable, due, probably, to the difficulty of keeping the soil of small samples at optimum moisture content for long periods and at the same time avoiding spoiling the texture. It is possible however to draw certain preliminary conclusions. The most marked and uniform fixation with all soils and under all conditions of incubation took place in September. This is the period at which the rapid increase took place in the field in 1916. Thus of 12 samples the average fixation was 15.5 per cent., and with one soil about 40 per cent. At no other date was there a consistent fixation with all samples. With the samples isolated in May and incubated till the following October, no definite increase was observed which was far outside the limits of the allowable error. The general course of events however appears to be similar, both with the different soils, and different conditions of incubation.

It seems legitimate to conclude, therefore, that the date of sampling is of the utmost importance in estimating the nitrogen-fixing powers of a soil in the laboratory. There appears to be a definite seasonal influence which must be taken into account.

The results so far obtained fail to enable us to form an opinion as to the effect of the partial sterilization possible in the soil under ordinary cultural conditions. In some cases the fixation was greater in the soil taken from the pulverized plots, and sometimes the reverse. The experiment was however conclusive in showing that it is not till after a prolonged period of dry heat that the soil

becomes capable of considerable nitrogen fixation. Much more data must be made available before we can hope successfully to correlate the results of chemical and biological examination with the seasonal influences. Our present knowledge appears to indicate that it is the seasonal influence which is of primary importance. It may therefore be necessary to await the passage of many seasons before it will be possible to discover all the factors which control nitrogen fixation in the soil. As in the case of influenza, the endemic activities of the soil organisms may afford much valuable information but it may be necessary to wait for the next epidemic before we shall be able to solve the problem of their sudden virulence.

Another aspect of the question which remains to be studied is seen if we consider that in order to utilize the nitrogen fixed in the soil, it must be subsequently nitrified. From the results obtained it appears that a rapid period of nitrogen fixation is followed by an almost equally rapid loss. If, however, it is found possible to control the nitrification of only a small fraction of the amounts of nitrogenous organic material which may be synthesized in the soil, we shall have travelled a long way in the direction of making the soil self-supporting in its nitrogen economy.

Almost the whole of the laboratory work referred to in this paper has been carried out by Mr. Barkat Ali. Acknowledgment must also be made to Mr. S. M. Nasir for much painstaking assistance.

ELECTRO-CULTURE.*

ALTHOUGH investigations into the influence of electrical discharge on plant growth are still in the preliminary stages and the economic possibilities of "electro-culture" are still uncertain, so much interest has been manifested in the subject that it is desirable to give a brief account of the work so far accomplished under the direction of the Electro-Culture Committee.¹ The scientific aspect of the work will be more fully dealt with in two papers which Professor V. H. Blackman is contributing to the "Journal of Agricultural Science." The Committee has now been at work for five years and has issued four interim reports²: the work completed in 1922 which was undertaken on lines suggested by the experience of previous years promises very striking results, but an account of that work must await the fifth interim report of the Committee which has not yet been presented.

In view of the complexity of the subject the Committee have confined their experiments to electro-culture by means of overhead discharge. Field experiments have been carried out for the Committee by Professor V. H. Blackman at Rothamsted with barley (1918 and 1920), winter sown wheat (1919 and 1920), winter oats (1921) and clover hay (1919, 1920 and 1921); at Lincluden (Dumfries) with oats (1918, 1919 and 1920) and potatoes (1921); and at Harper Adams Agricultural College with oats (1919, 1920 and

* Reprinted from *Jour. Min. Agri.*, XXIX, p. 792.

¹ The Committee was appointed in 1918, to "advise the Ministry of Agriculture and Fisheries in regard to all electrical questions in connection with the carrying out of experiments in electro-culture and particularly in regard to the construction of apparatus suitable for use on an economic scale, and to the making of such electrical measurements as may be necessary in connection with the experiments." The present constitution of the Committee is as follows:— Sir John Snell, M.Inst.C.E. (Chairman); Mr. A. F. Berry; Professor V. H. Blackman, F.R.S.; Mr. A. B. Bruce, M.A.; Dr. C. Chree, F.R.S.; Mr. W. R. Cooper, M.A., B.Sc., A.I.C.; Dr. W. H. Eccles, F.R.S., M.I.E.E.; Mr. P. Hedworth Foulkes, B.Sc.; Mr. J. S. Highfield, M.I.E.E.; Professor G. W. O. Howe; Professor T. Mather, F.R.S., M.I.E.E.; Mr. B. J. Owen, M.Sc., M.Eng.; Mr. H. G. Richardson, M.A., B.Sc.; Sir John Russell, F.R.S.; and Mr. C. T. R. Wilson, F.R.S.

² To be obtained free on application to the Secretary to the Committee, Mr. W. R. Black, B.Sc., Ministry of Agriculture, 10, Whitehall Place, S. W. 1.

1921), clover hay (1920) and pea and oat mixtures (1921). Pot-culture experiments have been carried out by Professor Blackman at Rothamsted in 1918, 1919, 1920 and 1921, with wheat, maize and barley; laboratory experiments to determine the effect of electric currents on the growth of plant organs have also been undertaken.

FIELD TRIALS.

Apparatus. The apparatus at Lincluden consisted of a mercury interrupter, supplied with a direct current at a voltage of 60, an induction coil and three Lodge valves in series. At Rothamsted it consisted of a petrol-driven "Delco" set, with at first a dry transformer and later an oil-cooled transformer, and a Newton and Wright disc-rectifier. At the Harper Adams Agricultural College current (100 volts D. C.) was available from the small electric lighting installation of the college. The apparatus consisted of a 2-h.p. motor coupled to a one K. V. A. A. C. generator (140 volts) which bore on an extension of its spindle a Newton and Wright disc-rectifier. An oil-cooled transformer (1-K. V. A.) giving a voltage up to 60,000 was employed for the discharge current.

Field installation. A steel cable supported on high tension insulators was fixed at a height of about 7 ft. at each side of the electrified areas and fine galvanized steel wires (gauge 29) spanned the distance between the cables. The wires were 5 or 10 ft. apart. The aerial installation was made positive.

At Harper Adams Agricultural College a screen of wire-netting, 8 ft. high, was fixed between the electrified area and the control area during one season's experiments.

Current. The currents varied at the different stations with different crops, and in the different years. Those in 1921 were as follows:—At Lincluden, the discharge was given at the rate of about 0.5 milliamp. per acre, the voltage (crest value) was about 25,000. At Rothamsted two installations were supplied from the same transformer, so that the current could be controlled in one only, that over winter oats being selected. With this crop the voltage (crest value) varied between 25,000 and 55,000 and the

total discharge current was maintained at the rate of 0·5 milliamp. per acre. The discharge given to the clover grass varied from 0·2 milliamp. to 0·6 milliamp. per acre. At Harper Adams Agricultural College also two installations were supplied from the same transformer. With oats the voltage (crest value) varied from 25,000 to 56,000, and the current was kept at about 1·0 milliamp. With the pea and oat mixture the current varied between 0·25 and 1·25 milliamp. per acre.

Period of discharge. The periods during which crops were subjected to the overhead discharge varied from 500 to about 900 hours. As a rule the period lasted from April to August and the discharge was continued for 6 or 8 hours daily.

Results of field experiments. The results from different crops in different years and at different stations are fully discussed in the four interim reports which should be consulted for details. The accompanying table, however, gives a general summary of results of field experiments from 1915 onwards (those from 1918 being under the auspices of the Committee). This summary does not include results obtained in 1921, the dry weather of that year being unfavourable for field experimental work.

The data taken as a whole show that of the fourteen *positive* results of experiments extending over six years only three are less than 10 per cent., while of the four *negative* results none reaches 10 per cent. Of the ten positive results with spring-sown cereals only two are less than 10 per cent., and six show an increase of 30 per cent. or over; while of the two negative results both show decreases of less than 10 per cent. The results of field experiments with these spring crops show an average increase of 22 per cent. The effect of electrification in increasing the yield of spring-sown oats and barley has thus been demonstrated. A beneficial effect on clover-hay is probable, while that on winter-sown wheat is still uncertain.

Spring-sown cereals.

DIFFERENCE IN YIELD PER
ACRE OF ELECTRIFIED
CROPS COMPARED WITH
CONTROL CROPS

						Actual	Relative
						Bushel	Per cent.
Lindluden	..	1915	..	Oats	..	+ 4·8	+ 30
"	..	1916	..	"	..	+ 11·2	+ 49
"	..	1917	..	"	..	+ 0·7	+ 2
"	..	1918	..	"	..	+ 26·7	+ 50
"	..	1919	..	"	..	+ 12·8	+ 35
"	..	1920	..	"	..	- 2·6	- 6
"	..	1920	..	"	..	+ 18·8	+ 57
Rothamsted	..	1917	..	Barley (small plots)	..	(+ 2·5)*	(+ 35)
"	..	1918	..	"	..	+ 4·4	+ 10
"	..	1920	..	"	..	+ 5·1	+ 19
Harper Adams College	..	1919	..	Oats	..	+ 1·0	+ 2
"	..	1920	..	"	..	- 4·3	- 9
Mean						+ 7·1	+ 22

Winter-sown wheat.

Rothamsted	..	1919	+ 6·0	+ 38
"	..	1920	- 0·7	- 4

Clover-hay.

						Cwt.	
Rothamsted	..	1919	..	(1st crop)	..	+ 11·7	+ 50
"	..	1919	..	(2nd crop)	..	+ 4·3	+ 34
"	..	1920	+ 0·5	+ 2
Harper Adams College	..	1920	- 3·0	- 6
Mean						+ 3·4	+ 20

* One result, that of the Rothamsted experiment of 1919 with wheat, has been excluded, for owing to special conditions the crop was a partial failure, yielding only 8 bushels to the acre. The decrease in yield of the electrified area as compared with the control was 7 per cent.

Also in calculating the differences in yield between the two areas, that of the Rothamsted barley plots of 1917 has not been included in determining the average, for the crop was harvested some time before maturity.

POT CULTURE EXPERIMENTS.

The object of these experiments carried out at the Rothamsted Experimental Station has been to obtain various data as to the

current to be used in electro-culture work on the early vegetative growth of cereals. The subjects investigated have been strength of current, the relative effects of direct and alternating current, and of upward and downward current and the period of the life of the growing crop when the discharge is most effective. Wire networks charged to a high voltage (4,000—16,000 crest value) were suspended at various heights above the plants; the current passing through plants was led off from the bottom of the insulated pots to a micro-ammeter reading to 0.01 microamp. The networks were made positive except for one set of experiments in 1921. The control pots were "earthed" in all cases.

In 1918 and 1919 the high tension discharge was obtained by the use of a mercury interrupter and an induction coil, Lodge valves being employed for rectification. In the experiments of 1920 and 1921 the installation consisted of a small rotary converter giving 70 volts A. C., and a wax-impregnated transformer made by Messrs. Newton and Wright. The overhead networks, when alternating current was used, were connected directly to the transformer; when direct current was required rectification was obtained by means of Lodge valves. The plants themselves were able to bring about some slight rectification.

The discharge in these pot experiments was usually given for about six hours each day. There were two experiments with wheat, nine with maize, and nine with barley.

In 1918 it was found that (under the conditions of the experiments) currents passing through the plants of the order 10×10^{-9} amp. were injurious in the case of the early vegetative stages of maize. Currents as low as 0.3×10^{-9} amp. appear to have an accelerating action on growth. The experiments of 1920 suggested that alternating current is as effective as direct current, if not more effective; the results obtained that year with direct current were, however, less satisfactory than in previous years.

The experiments of 1921 confirmed the results of 1920 that alternating current is usually as effective as, or more effective than, direct current. They further suggested that an upward current through the plant can increase growth in the same way as a

downward current; and, lastly, they suggest that a discharge applied for the first month only of the growing season may be at least as effective as one continued throughout the growing season—a result, if confirmed, of great importance since it shows that the running costs of crop electrification can be markedly reduced.

THE WORLD'S WHEAT POSITION.*

PROBABLE FALL IN PRICE.

BY

SIR JAMES W. WILSON.

ON August 1, 1921, the exporting countries ended the cereal year with an exportable surplus of old wheat still in hand amounting to about 15,000,000 qr. In the cereal year 1921-22 the weather was, on the whole, favourable, and the yield of wheat in those countries for which statistics are available rose to 397,000,000 qr., compared with 343,000,000 qr.—the average yield of the previous five years. Yet the importing countries, during the twelve months ended with July, 1922, imported approximately 81,000,000 qr.—or much the same quantity as they had imported the year before. Of this quantity Europe imported 69,000,000 qr., as compared with 69,000,000 qr. in 1920-21. A study of the statistics for the exporting countries shows that on August 1, 1922, they had still exportable surpluses of old wheat, after retaining enough for their own needs up to their next harvests, amounting to 15,000,000 qr. (Canada 2,000,000 qr., Argentine 4,000,000 qr., Australia 3,000,000 qr., India 6,000,000 qr.)—or much the same total as the exportable carry-over a year before.

POOR EUROPEAN CROPS.

Owing to unfavourable weather, the harvests of the current cereal year in many of the Continental countries of Europe have been disappointing, and for the twenty importing countries of the world for which estimates are available the yield this year is only 108,000,000 qr., as compared with 135,000,000 qr. last year and with their pre-war average yield of 138,000,000 qr. On the other

* Reprinted from *The Times Trade Supplement*, dated 25th November, 1922.

hand, for the fourteen exporting countries (including rough estimates of the coming crops in the Southern Hemisphere and in India), their yield during this cereal year is 271,000,000 qr., as compared with 262,000,000 qr. last year and with the pre-war average of 234,000,000 qr. For the countries of Europe, both importing and exporting (excluding Russia), the total yield this year is only 124,000,000 qr. as compared with 153,000,000 qr. last year and with 169,000,000 qr. before the war; so that if Europe required the same quantity of wheat during this cereal year as she required last year, she would have to import 29,000,000 qr. more this year than last year.

But the state of the European exchanges is such that, in order to import wheat from abroad, most of these countries must pay for it ruinous prices as measured in their local currencies, it seems probable that they will, for this reason, and also because of their general impoverishment, content themselves with a much smaller import than they would require to maintain their last year's consumption. According to estimates framed on the information available, the importing countries of Europe will probably import not more than 82,000,000 qr., as compared with the 69,000,000 qr. they actually imported last year; and, allowing 10,000,000 qr. for the importing countries outside Europe, as compared with the 12,000,000 qr. they imported last year, it may be estimated that the total demand of all the importing countries in the world this year will be about 92,000,000 qr., as compared with 81,000,000 qr. last year.

LARGE OVERSEA HARVESTS.

The exporting countries of the world have, on the whole, had better harvests this year than last. Canada's yield is estimated at about 49,000,000 qr., as compared with 38,000,000 qr. last year, and Canada alone is in a position to supply the whole requirements this year of the United Kingdom for wheat from abroad. Argentina is expected to reap next month a harvest of 27,000,000 qr., compared with 23,000,000 qr. last year. Australia's harvest promises to be fair. India, which is now free to export, had a very good harvest last May, and, as the weather has been exceptionally favourable for

sowing, may have a similarly good harvest next May. It seems probable that during the current cereal year the exporting countries taken together will have an exportable surplus of 117,000,000 qr., including the old wheat they could still spare on August 1 last. If, therefore, my estimate of 92,000,000 qr. as the probable demand of all the importing countries turns out to be correct, then the exporting countries will on August 1 next have left in their hands about 25,000,000 qr. of exportable old wheat, as compared with the 15,000,000 qr. left over on August 1 last.

A year ago, as I anticipated last November, the world price of wheat fell for some time, but about January last it began to rise again, partly owing to a disappointingly low official estimate of the Argentine harvest, and partly to the realization of the fact that the European importing countries, notwithstanding their comparatively good harvests in 1921, were likely to require about as much wheat from abroad as they had imported during the previous cereal year. The world price has lately risen again, owing, no doubt, to the poor yield of this year's harvests in Europe, and is now much the same as it was a year ago.

It now seems probable that the large surplus in North America, the appearance of a large surplus in the Argentine, Australia, and India, and the inability of the European Continental countries to maintain last year's rate of consumption will lead to a gradual fall in the world price of wheat. As regards the United Kingdom, it seems likely that the gold value of the paper pound sterling will continue to improve, that the present rates of ocean freight on imported wheat will fall, and that these changes, combined with a fall in the world price, will lead to a further fall in the price of wheat in this country, where it is still about 40 per cent. above the pre-war price.

Notes

MECHANICAL TILLAGE OF THE SOIL FOR SUGARCANE IN JAVA.

MR. C. E. VAN DER ZYL of the Sugar Experiment Station at Pasoeroean, Java, gives in the "Archief" (the periodical entirely devoted to the Java sugar industry), 1922, Part II, No. 4, pp. 155-193, a detailed and complete study and survey of the past and present trials with mechanical soil tillage in Java.

After paying a tribute to the work of the pioneers in this direction, the author gives the results of the recent experiments with the plough constructed by Mr. Van Dyk drawn over the field by MacLaren's cable engines and his own views on the matter in the following chapters devoted to "the relation between the period of planting and of the mechanical tillage of the soil," "ploughing *versus* Reynoso system, *i.e.*, planting in deep trenches," "the cable system and the earlier trials with the Heucke trench-making plough of the Netherlands Trading Co.," "ploughing with tractors," "the experiments with the MacLaren plough and cable tackle at the sugar factory of Bandjaratma in 1921," "trials with other engines" and finally a summary of the whole.

In regard to the period of planting, which for 70 per cent. of the area follows directly the harvesting time of the rice, and which it is impossible to curtail, mechanical tillage saves time only, when the trenching system is used. Ploughing of the heavy soils by means of tractors or cable tackle does not save any time, because the ploughed soil has to be left for nearly 8 days for drying purposes; only then the soil is fit to be harrowed and to be finally worked for planting.

The question whether ploughing or trenching is to be preferred for heavy soils has been decided by numerous experiments in favour

of trenching. Trenching in wet soils with tractors, however, meets a hitherto unsolved difficulty, *i.e.*, the slipping of the caterpillar.

The experiments with cable tackles have turned out better than those with tractors.

As a conclusion the author mentions that it principally depends on the heaviness of the soil, whether ploughing or trenching is to be preferred. Technically, ploughing of heavy soils is possible, but only at loss of time and money, while it gives no further advantages against trenching. Ploughed lands moreover need much water, and the cane grown in such lands lodges much more heavily.

The author's final conclusion appears to be in favour of motor cable tackle and trenching machines for mechanical soil tillage for sugarcane in Java.

* * *

STATISTICAL RECORD OF THE DISTRIBUTION OF THE CANE VARIETIES IN JAVA FOR THE CROP 1921-22.*

THE author publishes in 8 tables successively (1) the distribution of the cane varieties on each plantation of Java, (2) the distribution in each residency, (3) the figures of distribution in each residency put in percentages, (4) the total area planted with each variety in Java, (5) the distribution of each variety on the cane field of each plantation used for cuttings only, (6) the distribution of each variety on each plantation in each residency and the total area planted with cane from each of the three types of cuttings, *viz.* :—

(a) cuttings from the tops of the cane stalks, taken directly when harvested,

(b) cuttings from special nurseries in the plains for taking cuttings only,

(c) cuttings from the nurseries in the mountains.

The tables also show the quantity of cuttings from the nurseries in the mountains used on each plantation and the same distribution in each residency.

The author shows that the variety E.K. 28 occupied an area of 56,800 hectares † which represents 39 per cent. of the total area

* J. Van Harreveld. *Archief voor de Suikerindustrie*, 1922, Pt. II, pp. 391-412.

† 1 hectare = 2.47109 acres.

planted with cane in Java. In the order of their importance the other varieties are D.I. 52 ($18\frac{1}{2}$ per cent.), 247 B. ($17\frac{1}{4}$ per cent.), E.K. 2 ($6\frac{1}{2}$ per cent.), 100 P.O.J. (4 per cent.), 90 F. ($3\frac{1}{4}$ per cent.), S.W. 3 ($2\frac{1}{2}$ per cent.), 2714 P.O.J. (2 per cent.), and 2725 P.O.J. ($1\frac{1}{2}$ per cent.).

* * *

DISTRIBUTION OF LIVING PLANTS BY POST.

THE distribution of improved plants evolved in Government and other nurseries is much handicapped in this country by the high cost of transit by railway, and the already difficult position has been made worse by the recent increase in railway freights. The writer has therefore evolved a method by which plants can be sent from Poona in good condition through parcel post so far as Aden and Burma. The postal rates being independent of the distance the parcel has to be carried, the new method is much cheaper, and it also ensures speedy delivery. Two instances within the actual experience of the writer may be cited to demonstrate the advantages of using parcel post for carrying living plants. In one case, nine orange plants were sent from Kirkee to Kumta, a place on the Kanara Coast, by the usual method—a combination of train and road transit—and the cost per plant reached R. 1-7-3. A second batch was sent to the same place by post, and the transit cost amounted to only As. 4 and 10 pies per plant. In another case, plants sent by rail and steamer reached Aden at a cost of Rs. 4-10-8 per plant, while another consignment went by post at a cost of only As. 8 per plant. In both cases the plants sent by post were reported to have arrived in excellent condition, and equally good results were obtained in sending them to Ceylon and Burma.

The following method of packing plants for despatch by post and reviving them on arrival will be of interest to those who want to take advantage of it.

1. *Packing.* After the plants are selected, they should be well hardened by exposure to full sun and wind for a fortnight. All the leaves should then be cut off and the soil carefully removed from the roots by keeping the plants in water for fifteen minutes and then shaking gently in the water. Each plant should next be wrapped

loosely in oil paper. Blotting paper should be kept all round the inside of the package, and over it a moist piece of gunny cloth should be placed. A layer of about an inch of moist moss should be spread over the gunny cloth and the interspaces between the plants should also be filled with moist moss. The wooden box containing the plants so packed should then be nailed up, and despatched in the usual manner.

2. *Reviving of plants if to be planted straight into the field.* After the parcel is opened, the plants should be kept in a bucket of water for half an hour. The soil of the holes prepared to receive them should be made moist before the plants are planted. Shade all round and over the plants should be carefully provided for by gunny bag or matting. After planting, a piece of wet cloth should be tied over the bare stems, till the eyes begin to push. Sprinkling of water over the matting and cloth should be done four times a day. After the plants have thrown out leaves, a gradual hardening of plants should be effected by first removing the matting from the eastern and then from the southern or northern side according to the position of the sun. Finally, the shade should be removed from over the top of the plants.

3. *Instructions for reviving plants if to be potted.* Two or three days previous to the receipt of the consignment a hole about three feet deep and two feet square should be dug in the ground the bottom and sides of which should be thoroughly wet. Such a hole will hold four plants provided the diameter of the mouth of the pots used is not more than ten inches and the height of the pot is not more than one foot. The dimensions and the depth of the hole will increase or decrease in proportion to the decrease or increase in the height and the diameter of the pots used.

The plants on receipt should be dipped in water for half an hour, after which they should be potted. In the potting compost no manure should be used. It should be a mixture of loose soil from the surface of the ground and fine sand, half of each. This compost should be made moist before being used for potting.

After potting the plants should be thoroughly watered and kept in the hole, which should be covered by a piece of thick gunny bag.

Care should be taken to moisten the gunny four or five times and the air in the hole should be kept cool by syringing with water several times during the day.

When the buds begin to push into leaves, heat and light should be given gradually, by removing the gunny covering for a short time in the morning and evening. The period during which the gunny is removed should gradually be increased until the leaves show a dark green colour. When this stage is reached it can be removed altogether.

Fifteen days later the plants should be gradually taken out to a spot where they will get full sunshine. The pots should be plunged up to the rim in the ground, over which a layer of leaves, two inches thick, should be spread. For some time watering will be necessary every day.

The method described has been applied by the author with success to guava plants, various types of *Citrus* plants including pomelo, mango plants, *chiku* plants (*Achras sapota*), fig plants, grape vines, wood apple plants (*Feronia elephantum*) and pineapple plants. [P. G. JOSHI.]

* * *

CO-OPERATIVE COTTON MARKETING.

The "Textile World" (New York), for September 30th, 1922, gives an interesting account of the American Cotton Growers' Exchange, a federation of the co-operative marketing associations in eight States.

The constituent associations are said to have contracts for the delivery to them of the following quantities of cotton (based on a normal yield):—

		Bales.
Oklahoma	525,000
Texas	600,000
Arkansas	270,000
North Carolina	400,000
South Carolina	440,000
Georgia	268,000
Alabama	169,000
Arizona	20,000
TOTAL	2,692,000

Last year the value of the cotton handled by co-operative marketing associations aggregated 40,000,000 dollars from four States only. A sales manager for the exchange (Mr. C. B. Howard) with 30 years' experience of cotton business has been appointed, and the exchange is governed by a Board of Directors composed of 3 men from each association. As legal adviser the exchange have retained Mr. Aaron Sapiro to whom is due much of the credit for the present organization and who has advised 57 co-operative marketing associations in the United States.

The President, Mr. Carl Williams, started the Oklahoma Cotton Marketing Association with Mr. Sapiro's advice; the Secretary, Mr. Moser, was the driving force in the organization of the Texas growers.

The future of the organization which, it will be observed, already claims to control about $\frac{1}{3}$ th of the total American cotton crop, will be watched with interest.

Mr. Sapiro considers that the essentials to the success of co-operative marketing are :

1. Base your organization on the commodity.
2. Let none but *producers* of this commodity become members.
3. Tie all members together by a legal and enforceable long term contract.
4. Be sure that you control enough of the commodity to be a factor in the market.
5. Pool the products of members, arranging them in even running lots according to grade and quality.
6. Hire experts to do the work.

It is stated that it is the intention of the co-operative cotton marketing movement to use existing channels of trade as far as possible and that cotton exporters are only too glad to take advantage of the co-operative marketing associations' organization which, by assembling the cotton at suitable centres and classifying it for grade and staple, makes it possible for the exporter to buy large even running lots.

Co-operative sale societies are still in their infancy in India. Initial difficulties are great but not greater than have been successfully faced by the co-operative credit societies. Failures in the early stages in America were numerous but it is claimed that no failure has ever occurred of an association started on the "Sapiro" plan. If co-operative sale societies in India are even to be a real factor in obtaining for the grower of agricultural produce a fair return for his labour, a definite policy must be followed.

The American Association has achieved success by adherence to clearly defined principles and these deserve very careful consideration from all those interested in co-operative development in India. [B. C. BURT.]

* * *

RESTRICTIONS ON IMPORT OF POTATOES.

IN exercise of the powers conferred by sub-section (1) of section 3 of the Destructive Insects and Pests Act, 1914 (II of 1914), the Governor-General in Council is pleased to direct that the following proviso be added to rule 4 of the Rules published with the notification of the Government of India in the Department of Revenue and Agriculture, No. 580-240, dated the 26th June, 1922 (*Agri. Jour. India*, XVII, Pt. 5).

"Provided that potatoes may be imported from Italy if they are accompanied by a certificate of immunity from disease granted by a Royal Phytopathological Institute in Italy."

* * *

AGRICULTURAL DEVELOPMENTS IN THE GOLD COAST.

WE have received the following for publication from the Imperial Institute :—

The principal industry in the Gold Coast is the production of cocoa, the exports of which constitute about one-fourth of the world's commercial supply and have an annual value of over £10,000,000. The crop is grown entirely by the people themselves. Attempts are being made by the authorities to assist cultivators in parts of the colony where cocoa is not grown by introducing new

agricultural industries, and an interesting account of these developments, prepared by the Deputy Director of Agriculture, is given in the "Bulletin of the Imperial Institute" (XX, No. 3).

Along the 300 miles of sea-coast there is much land suitable for the planting of coconuts, which at present are only grown to a small extent in the Eastern Province. The Government have obtained on loan from the local Chiefs plantations of 300 acres each in the Western and Central Provinces, and small ones amounting in the aggregate to 300 acres in the Eastern Province. The land is being planted with coconuts, and drying houses and store houses are being erected for the preparation of *copra* (the dried coconut from which coconut oil is obtained). It is hoped in this way to demonstrate that a profitable industry can be built up as an adjunct to the fishing industry, which is at present the principal occupation of the coast inhabitants. When the cost of establishment has been recovered the Government propose to hand the whole concern over to the local Chiefs for the benefit of their communities.

Similar action is being taken in connection with the introduction of sisal-hemp, which promises to do well in certain parts of the colony. A plantation of 1,000 acres is being used as a demonstration area, and in this case also, when the cost of establishment has been met, the plantation, complete with decorticating machinery, tram-lines, and all other accessories, will be handed over to the local Chief and his people for their own benefit.

* * *

RHINOCEROS BEETLE.

DURING the course of a tour in the North Kanara District, Bombay Presidency, the writer has noticed a fairly successful method of trapping the Rhinoceros Beetle (*Oryctes rhinoceros*) practised by a coconut planter at Sirsi. It consists in keeping castor-cake rotting in a semi-solid condition in earthen pots at various places in the plantation. The smell of the decaying castor-cake attracts the beetles which, once settled on the stuff, die in the pots. A man goes round occasionally and picks out the dead beetles. At the time of his visit the writer saw several insects entrapped in the pots

and as many lying outside. During the rainy season it is necessary to shelter the pots with thatch, so that the contents may not be diluted or flooded out. [V. G. GOKHALE.]

[One well-known method of control is to accumulate heaps of decaying vegetable matter in the palm-groves for the beetles to oviposit in and destroy the larvæ at regular intervals. In some places these heaps are inoculated with a fungus that attacks the larvæ. The practical danger of such traps in India is that they are not regularly attended to and hence become foci for breeding. T. B. F.]

* * *

SUGAR PRODUCTION FROM TROPICAL PALMS.

WE have received the following for publication from the Imperial Institute :—

Various palms occurring in the tropics yield a sugary sap which is employed by the people for making sugar and “toddy,” and a summary of information relating specially to the Nipa palm from this point of view is given in the “Bulletin of the Imperial Institute” (XX, No. 3). This palm grows commonly in the muddy estuaries of rivers throughout the eastern tropics, and is exploited particularly in the Philippine Islands. The sugary juice or “tuba” is obtained by removing the flowering shoot and collecting the juice which escapes from the cut surface. By repeatedly cutting the end of the stalk the flow of juice can be maintained for two or three months, each stalk yielding about 9 or 10 gallons of juice during this period. The juice contains about 15 per cent. of sugar, which can be extracted by means somewhat similar to those used in the manufacture of cane sugar, or, if desired, the juice can be fermented for the production of alcohol.

It has been estimated that 28 cwt. of sugar or 200 gallons of 95 per cent. alcohol could be obtained annually from an acre of swanp land planted with Nipa palms. The tree occurs over extensive areas in British North Borneo, and the authorities there are considering the question of utilizing it as a source of sugar and alcohol, whilst it would appear that there are also possibilities of its being similarly utilized in Malaya.

IDENTIFICATION OF DAIRY COWS BY NOSE-PRINT.

FINGER-PRINT identification of criminals and suspects has been in use for more than twenty years. It has taken a long time for anyone to think of applying the principle to the identification of dairy cows. This, however, is now being worked out with every

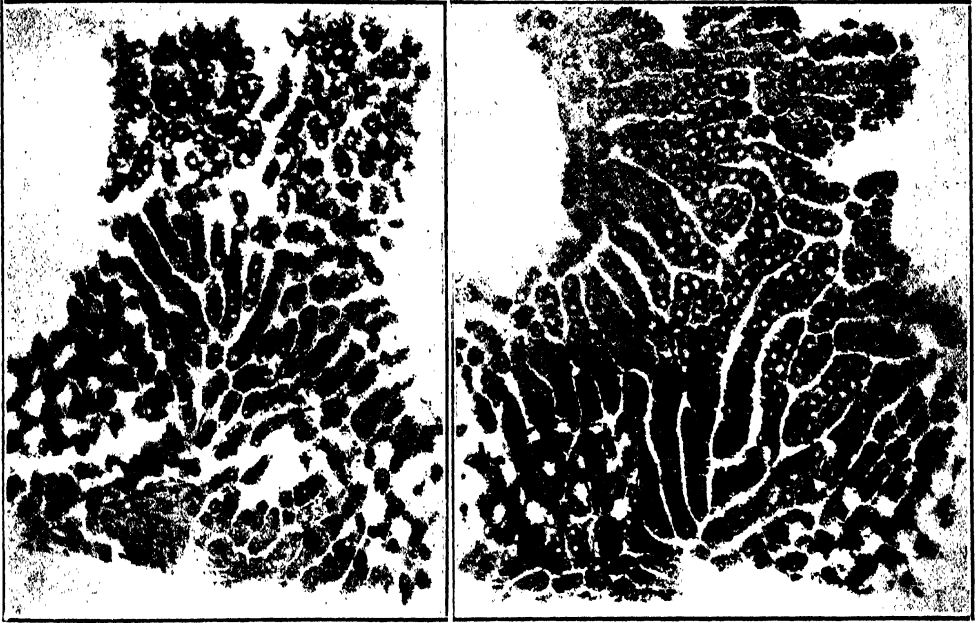

Two typical nose prints of cows, showing how readily the identification may be established with this record.

prospect of success in the Division of Dairy Husbandry at the University of Minnesota. The cow's nose is traversed by innumerable ridges similar to those of the human hand, and from the patterns of these a solution has been indicated of the problem of positively identifying individual cows.

This has always been a very real difficulty. In registering and selling high-priced animals, and in conducting official milk tests over a period of several months, the greatest care must be taken against intentional or accidental substitution of animals. With the broken-coloured breeds like the Holsteins and Guernseys, a sketch of the markings is required, but it is found that many farmers are unable to make a sufficiently accurate drawing to avoid dispute

when the question of identity arises. In the solid-coloured breeds like the Jerseys the situation is even worse ; tattoo marks may always be limited. and two-thirds of the Jersey cattle answer to the official description "solid colour, black tongue, black switch." With unregistered breeds the owner's word must be taken without reserve for the animal's identity. Even when there is no intent to deceive, mistakes of identity, it is believed, are frequent.

Experiments in taking and classifying nose-prints were begun in October 1921. As with finger-prints, two important points must be considered. Is the cow's nose-print different from that of every other cow ? And does the pattern remain the same at all ages ? As with the human finger, both these questions must be answered in the affirmative before the nose-print will be of value in identification.

The prints of more than 350 animals have been taken and carefully scrutinized. So far no two have been found even sufficiently alike to cause any uncertainty as to their being from different animals. And both growing calves and older animals have been nose-printed for five consecutive months without indicating any change of design. A careful study of the prints indicates that while there is enlargement of the nose, the arrangement of the ridges remains fixed.

It is simple and easy to take the prints and to instruct others in doing so, by mail. One man does the trick, holding the cow's head under his arm and working with his free hand. The nose is wiped dry with a flannel cloth, because the cow sweats freely through the nose. A common stamping pad is then rubbed back and forth or pressed against the nose until the ridges are well inked. Then the print is taken by pressing firmly against the inked nose a sheet of soft paper fastened to a board, beginning with the lower edge of the paper, at the base of the upper lip, and rolling upward toward the face. Ordinary black stamping-pad ink is the most satisfactory, with printers' or mimeograph ink a second choice.

The system is being given a practical test in connection with various official tests in Minnesota. Already its value has been manifest, and it has straightened out several cases of disputed or mistaken identity. Perhaps its greatest value will be to the

live-stock insurance companies. All these concerns claim that they have paid many claims where they suspected but could not prove that the policy covered some other animal than the dead one. With a system of nose-print identification, such false claims could be detected and proved. [CHARLES F. COLLISON : *Scientific American*, November 1922.]

* * *

COTTON SPINNING IN CHINA.

ACCORDING to investigations by the Japanese Department of Agriculture and Commerce the cotton spinning industry in China is making rapid progress. At present there are working in the country 69 spinning mills with 1,870,000 spindles and 10,800 weaving looms. The annual output of the spinning mills in China is estimated at 800,000 to 1,000,000 bales of yarn and 3,200,000 yards of cotton fabrics. Besides these, 109 factories are now in course of construction, and when they are completed 3,200,000 additional spindles and 16,000 looms will be working. China's producing capacity of cotton will thus be increased to something like 1,700,000 bales, and that of cotton fabrics to 8,000,000 yards in the course of a year or two. The number of spindles and looms in China according to nationality is as follows:—

Spindles

	Japanese	Other Foreigners	Chinese
In operation	372,180	259,286	1,238,782
Under construction	494,740		837,700
TOTAL	866,920	259,286	2,076,482

Weaving looms.

In operation	1,980	2,153	6,675
Under construction	1,000	440	3,970
TOTAL	2,980	2,593	10,645

It is estimated, says Reuter's Tokyo trade correspondent, that when all the spindles now under construction are in operation the yearly consumption of raw cotton will amount to 11,000,000 piculs, and as China's supply of raw cotton will not exceed 7,000,000 piculs at most it remains an interesting point of speculation as to whence the China spinners will draw their supply of cotton. [*The Textile Mercury*, LXVII, No. 1750.]

* * *

COTTON RESEARCH.

THROUGH the courtesy of the British Cotton Industry Research Association, the Secretary of the Indian Central Cotton Committee has sent the following abstracts for publication :—

SHEDDING OF FLOWER-BUDS AND BOLLS OF SEA ISLAND COTTON.

THE external and internal factors responsible for the premature shedding of the flower-buds and bolls of Sea Island cotton in St. Vincent have been studied. The general conclusion is drawn that the proportion of shedding over any given period is the resultant of two opposing factors, the rate at which food is synthesized by the plant and the rate at which it is utilized in the maturation of the fruit ; and that any check in the former augments the rate of shedding. Any factor which injures the boll, such as fungoid and bacterial diseases, insect depredations, etc., causes the shedding of the boll provided the injury is sufficiently pronounced as to interrupt the translocation of food into the boll. [*Annals of Botany*, 1922, **36**. 457-483. T. G. MASON.]

CONTROL OF COTTON WILT.

FIELD experiments are described which have led the author to believe that cotton wilt may be controlled by the application of commercial fertilizers containing potash. Kainite was used. The author is unable to explain the action of the potash. [*Jour. Agronomy*, 1922, **14**, 222-224. L. E. RAST.]

COTTON CULTIVATION IN CHINA.

THE total production of raw cotton in 1921 showed an increase of about 20 per cent. over the output in 1920. Cotton of both

Chinese and American species is cultivated. Of the Chinese species there are the dark seed and the white seed varieties, and of the American varieties the long fibre and golden fibre. In such districts as Chienhsien the soil is especially adapted to the cultivation of American cotton, whilst in other parts of the province both the Chinese and American species can be grown with equally good results. There is a cotton experiment station at Sankow. The output in this district during 1921 amounted to nearly 17½ million lb. [*Abstr. Text Inst.*, 1922, **13**, 194 ; from *U. S. Commerce Reports*, 1922, 17th July, 163.]

COTTON CULTIVATION IN NATAL.

THE results of recent cotton-growing trials in Natal are recorded. Production has been considerably increased over the whole of Natal in the last few years but marketing the crop is a serious question which still remains to be solved. Long-stapled American Upland varieties have proved to be the most suitable for the conditions, whilst all attempts at ratooning, irrespective of the variety or class of cotton, have resulted in failure. The cotton thrives best on the rich soils of the low, hot valleys, and the best soils of the coastal belt, but not too near the sea and in exposed positions. [*Bull. Agri. Intell.*, 1921, **12**, 1147-1148 ; from *Farmer's Weekly*, 1921. **21**, 1178-1179. W. B. WILSON.]

COTTON CULTIVATION IN WEST AFRICA.

THE economic reasons for the apparent failure of the cotton growing schemes in French West Africa are outlined. Native cultivation of cotton does not pay as the yield is poor, because of the very primitive methods of cultivation and because the climate is often unfavourable. Dry cultivation by Europeans results in a much better yield, but this type of cultivation would not pay if the exchange were not so much in favour of the growers. Irrigation appears to be the only means by which cotton cultivation can be definitely improved. A scheme has accordingly been undertaken for the development of French West Africa. [*I'Ind. Text.*, 1922, **38**, 485-486. YVES HENRY.]

**PERSONAL NOTES, APPOINTMENTS AND TRANSFERS,
MEETINGS AND CONFERENCES, ETC.**

WE much regret to record the death of Dr. Thakur Mahadeo Singh, Offg. Deputy Director of Agriculture, North-Eastern Circle, United Provinces. Dr. Singh joined the Department in October, 1920, as Assistant Agricultural Chemist.

THE New Year's Honours List contains the following names which will be of interest to the Agricultural Department :—

Rai Bahadur. MR. CHANDRA SHEKHAR MISRA, B.A., First Assistant to the Imperial Entomologist, Agricultural Research Institute, Pusa.

Rao Sahib. MR. BHIMBHAI MORARJI DESAI, Deputy Director of Agriculture, Gujarat, Bombay Presidency.

Rai Sahib. BABU PRIYA NATH DAS, Assistant Director, Civil Veterinary Department, Bihar and Orissa.

* * *

MR. C. H. MARTIN has been appointed Assistant Secretary to the Government of India in the Revenue and Agriculture Department.

* * *

MR. G. S. HENDERSON, N.D.A., N.D.D., Imperial Agriculturist, Pusa, has been granted leave on average pay for seven months from the 1st April, 1923, or any subsequent date on which he may avail himself of it.

MR. J. H. WALTON, M.A., M.Sc., Assistant Bacteriologist, Pusa, has been granted combined leave for one year from the 17th February, 1923, Mr. N. V. Joshi, M.Sc., B.A., L.Ag., officiating.

* * *

THE designation of the Imperial Branch of the Civil Veterinary Department will hereafter be the Indian Veterinary Service.

* * *

THE London University has made a grant of £ 15 to the honorary editor for zoology of "The Annals of Applied Biology" in aid of the publication in that journal of the M.Sc. thesis entitled "The Life-history and Bionomics of the Turnip-gall Weevil" by Mr. P. V. Isaac.

* * *

RAI BAHADUR K. RANGACHARI, M.A., Government Lecturing Botanist, Agricultural College, Coimbatore, has been granted leave on average pay for four months, Mr. Tadulinga Mudaliyar officiating.

* * *

MR. R. W. LITTLEWOOD, N.D.A., Deputy Director of Agriculture (Live Stock), Madras, has been granted an extension of leave for 12 days from the 2nd May, 1923.

* * *

MR. V. S. KRISHNAMURTI AYYAR has been promoted from the Madras Provincial Veterinary Service to the Indian Veterinary Service from the 30th June, 1922, and posted to Madras.

* * *

MR. D. A. D. AITCHISON, M.R.C.V.S., on return from leave is reposted as Principal, Veterinary College, Madras.

* * *

MR. R. S. FINLOW, B.Sc., F.I.C., Offg. Director of Agriculture, Bengal, has been appointed to act as Director of Fisheries, Bengal, in addition to his own duties, with effect from the 17th October, 1922.

MR. C. A. H. TOWNSEND, I.C.S., has been, on return from leave, reposted as Director of Agriculture, Punjab, from the 19th December, 1922, relieving Mr. D. Milne. Mr. Townsend has also been appointed a member of the Imperial Legislative Assembly.

* * *

MR. D. MILNE, B.Sc., Economic Botanist, Punjab, has been appointed to the selection grade of Rs. 1,500-50-1,750 in the Indian Agricultural Service from the 2nd November, 1922.

* * *

THE headquarters of the Director of Agriculture, Burma, has been transferred from Maymyo to Rangoon.

* * *

MR. M. MCGIBBON has been appointed to the Indian Agricultural Service and posted to Burma as Economic Botanist.

* * *

MR. R. WATSON, Deputy Director of Agriculture, Burma, has been transferred from Hmawbi and posted to the charge of the Arakan Circle, with headquarters at Akyab, from the 2nd January, 1923.

* * *

MR. R. T. PEARL, B.Sc., Mycologist to Government, Central Provinces, has been granted combined leave for eight months, Mr. J. F. Dastur, M.Sc., D.I.C., Supernumerary Mycologist, Pusa, officiating.

* * *

MR. W. HARRIS, M.R.C.V.S., Superintendent, Civil Veterinary Department, Assam, has been granted combined leave for nine months from the 1st March, 1923, Babu Guru Prasanna Sen officiating.

* * *

THE Fifth Entomological Meeting was held at Pusa from the 5th to 10th February, 1923. The meeting was attended by over 40 persons interested in the study of Indian insects, and some seventy papers were read. The proceedings will be published in due course and a fuller account given in the next issue of the Journal.

Reviews

Agricultural Progress in Western India.—By G. KEATINGE, C.I.E.
(London: Longmans, Green & Co.)

THIS book is a sequel to “Rural Economy in the Bombay Deccan” written by the same author ten years ago. The older book gave the salient facts of agriculture in the Deccan, and the one under review attempts to estimate the progress made in agriculture in the Bombay Presidency. It is a valuable work regarded as political economy with regard to agriculture, and worthy of careful study by Government, legislators, co-operative credit workers, agricultural experts in all parts of India, and in fact all who are trying to ensure progress in the main industry of India. The author was Director of Agriculture in the Bombay Presidency for 16 years and has had much opportunity to study the conditions and difficulties of agriculturists.

Chapter II dealing with progress in other countries is very interesting and forms a very good summary of main lines of improvement effected elsewhere. The author lays great stress and rightly so on the evils of fragmentation and sub-division of holdings, and Chapter IV and Appendices 1, 2 and 3 deal extensively with this aspect. There is no doubt that in the greater part of India this evil is the most important factor militating against progress. It is interesting to note that in the Punjab efforts are being made, and with considerable success, to consolidate holdings through the agency of the co-operative credit movement. The educative influence of such an attempt must be enormous and should pave the way to some form of legislative enactment at a later date. Until the sense of the community is educated to the extreme necessity of reform, this would seem to be the best way of preparing the ground.

Chapters V, VI, VII and VIII deal with technique, equipment, organization and the human factor, and are dealt with in an interesting manner. Some of the statements are too general, thus on page 101 it is stated "that a single heavy dressing of crude night-soil will double the outturn of the crops for several years in Khandesh, will increase it by 50 per cent. over a period of 10 years in Surat, and will double the *jowari* (sorghum) crop in Dharwar, and add materially, though to a smaller extent, to the cotton crop." If such results are claimed from Government farms, possibly other factors such as better cultivation contribute to the results. Anyway the differences are so marked, and the claims so high, that it would be advisable to give definite evidence, or at any rate set about experiments to thresh the matter out one way or the other. Again, as regards iron ploughs "it is well known that more progress has been made in Western India" than in any other part of the Peninsula, and it would have been worth while to give some definite figures as to numbers and types of iron implements in general use.

In the last Chapter an agricultural policy for Western India is put forward, and twelve points at the end of the book summarize the main points of policy to be followed. It is interesting to note that among the latter large estates are advocated for encouraging the dairy and sugar industries. Also the regulation of the movement of cotton to prevent fraudulent practices as advocated by the Indian Cotton Committee is commended as the type of legislation required. Similarly attempts to control exports of foodstuffs are condemned as likely to defeat their end.

The book is clearly printed and well got up and cannot fail to be suggestive to anyone interested in the progress of Indian agriculture. [W. R.]

* * *

The Ferns of Bombay.—By F. BLATTER, S. J., PH.D., F.L.S., and J. F. d'Almeida, B.A., B.Sc. Pp. viii+228; 16 plates; 43 figs. (Bombay: D. B. Taraporevala, Sons & Co.) Price, Rs. 7-8.

THIS small work gives an account of the ferns found in the Bombay Presidency. The book falls into two parts. The first is the

Introduction, consisting of six short chapters dealing with previous writings on Bombay ferns and with the structure, life-history, reproduction, distribution and cultivation of ferns generally. The second part is devoted to classification and gives in the usual manner a systematically arranged description in botanical language of the orders, genera and species with a few notes on habitat.

This second part is the really valuable part of the book because it puts together in a handy form material which otherwise would lie scattered in several larger volumes and it indicates where the ferns named are likely to be encountered. There are also given line drawings, photographs and coloured plates which assist the botanist in identifying plants collected.

Although this book is apparently intended both for the systematic botanist and the amateur, it will be of most use to the systematic botanist, as a local flora for the fern group. The Introduction is altogether too slight to enable the amateur to make use of the second part. It is very doubtful how far it is possible to make a book both popular and scientific. Doubtless it can be done, but if the volume under review were to be made more useful to the amateur then the Introduction would need to be less condensed. For example, no details are given as to the use of the lens or the microscope in the study of sporangia, although it has been thought necessary to give in some detail the nomenclature for forms of leaves. Again, the explanation of the gametophyte generation and its structure is bound to puzzle the amateur as no indication is given of the degree of magnification of the drawings of the antheridium and archegonium, nor any statement that the latter drawing is a section. The amateur will look in vain for structures like these in the prothallus (if he is fortunate enough to be able to identify a prothallus). The botanist does not need the information.

In a book like this there should be some comprehensive bibliography to lead the reader (whether amateur or professional) on to other parts of the subject and to illuminate parts not fully dealt with in the book. [W. B.]

NEW BOOKS

ON AGRICULTURE AND ALLIED SUBJECTS

1. Farm Book-keeping : The Principles and Practice of Book-keeping applied to Agriculture : for Agricultural Colleges, Extension Courses, Evening Classes and Practical Farmers, by John Kirkwood. Pp. 224. (Edinburgh : W. Green & Son, Ltd.) Price, 6s. net.
2. Veterinary Hygiene, by R. G. Linton. Pp. 415+92 illus. (Edinburgh : W. Green & Son, Ltd.) Price, 26s. net.
3. Researches on Fungi, by A. H. R. Buller. Vol. II. Further investigations upon the Production and Liberation of Spores in Hymenomycetes. Pp. 492. (London : Longmans, Green & Co.) Price, 25s.
4. A Dictionary of Applied Chemistry, by Sir E. Thorpe, assisted by eminent contributors. Vol. IV, revised and enlarged edition. Pp. 748. (London : Longmans, Green & Co.) Price, 60s.
5. General Biology, by Leonas L. Burlingame, Harold Heath, Ernest Mortin and George L. Peirce, of Stanford University. Pp. xxix+568. (New York : Henry Holt & Co.) Price, 3.50 dollars.
6. Genetics : An Introduction to the Study of Heredity, by H. E. Walter. Revised edition. Pp. xvi+354. (London : Macmillan & Co.) Price, 10s. net.
7. Vaccine and Serum Therapy in Veterinary Practice, by L. C. Maguire. Pp. viii+127. (London : Baillière, Tindall & Cox). Price, 5s.

THE following publications have been issued by the Imperial Department of Agriculture in India since our last issue :—

Memoirs.

1. *Helminthosporium* spp. on Cereals and Sugarcane in India, Part I (Diseases of *Zea Mays* and *Sorghum vulgare* caused by species of *Helminthosporium*), by M. Mitra, M.Sc. (Botanical Series, Vol. XI, No. 10.) Price, R. 1 or 1s. 4d.
2. The Wheats of Bihar and Orissa, by Albert Howard, C.I.E., M.A.; Gabrielle L. C. Howard, M.A.; and Abdur Rahman Khan. (Botanical Series, Vol. XII, No. 1.) Price, As. 8 or 9d.
3. A Note on Hydrocyanic Acid in the Burma Bean (*Phaseolus lunatus*, sp.), by F. J. Warth, M.Sc., B.Sc. (Chemical Series, Vol. VII, No. 1.) Price, As. 12 or 1s.
4. Studies in Indian Dermaptera, by Mergan Hebard. (Entomological Series, Vol. VII, No. 11.) Price, R. 1-4 or 1s. 9d.

Bulletins.

5. Methods of Examination of certain Characters in Cotton, by G. R. Hilson, B.Sc. (Bulletin No. 138.) Price, As. 8.
6. The Determination of Prussic Acid in Burma Beans (*Phaseolus lunatus*) (Preliminary Note), by J. Charlton, B.Sc. (Bulletin No. 140.) Price, As. 3.
7. Comparative Manurial Value of the Whole Plants and the different parts of Green Manures, by N. V. Joshi, B.A., M.Sc., L.Ag. (Bulletin No. 141.) Price, As. 6.

Report.

8. Review of Agricultural Operations in India, 1921-22. Price, R. 1-4.

SALE OF PEDIGREE DAIRY BULLS.

A SALE of pedigree Dairy Bulls of the Sahiwal (Montgomery) Breed, bred on Government Military Dairy Farms in the Punjab, will be held at the Military Dairy Farm, Ferozepore Cantonment, on 26th March, 1923, at 9-30 A.M. Catalogues available early March on application to the Assistant Controller, Dairy Farms, 2nd Circle, Kasauli.

PUBLICATIONS ON INDIAN AGRICULTURE

AT CONCESSION RATES

**For Students & Ex-Students of Agricultural
Colleges & Subordinate Officers of Agricultural
Departments.**

- The Agricultural Journal of India
Up to Vol. XI. Vols. III, IV, X, and
XI are complete ; odd copies of other
volumes also available Rs. 3 per Vol.
- Scientific Memoirs. *All series* ... Half price.
- Bulletins and Indigo Publications ... Two-thirds price.
- Scientific Reports of the Pusa Institute,
1905-06—1918-19 Half price.
- Report on the Progress of Agriculture
in India, 1907-09, 1909-10, 1911-12—
1918-19 Half price.
- Proceedings of the Board of Agriculture Half price.
- Reports on Introduction of Improve-
ments in Indian Agriculture ... Half price.

Postage Extra.

Apply to—

Director, Agricultural Research Institute,

PUSA (Bihar)

VOL. XVIII, PART III

May, 1923

THE AGRICULTURAL JOURNAL OF INDIA



EDITED BY

The Agricultural Adviser to the Government of India

PUBLISHED FOR

THE IMPERIAL DEPARTMENT OF AGRICULTURE IN INDIA

BY

THACKER, SPINK & CO., CALCUTTA

W. THACKER & CO., 2, CREED LANE, LONDON

Price R. 1-8 or Two Shillings

Agents for the Sale of Government Publications

IN EUROPE

- Constable & Co., 10, Orange Street, Leicester Square, London, W.C.
Zegan Paul, Trench Trübner & Co., 68-74, Carter Lane, E.C., and 25, Museum Street, London, W.C.
Bernard Quaritch, 11, Grafton Street, New Bond Street, London, W.
P. S. King & Sons, 2 & 4, Great Smith Street, Westminster, London, S.W.
H. S. King & Co., 65, Cornhill, E.C., and 9, Pall Mall, London, W.
Grindlay & Co., 54, Parliament Street, London, S.W.
Luzac & Co., 46, Great Russell Street, London, W.C.
W. Thacker & Co., 2, Creed Lane, London, E.C.
T. Fisher Unwin, Limited, 1, Adelphi Terrace, London, W.C.
B. H. Blackwell, 50 & 51, Broad Street, Oxford.
Deighton, Bell & Co., Ltd., Cambridge.
Oliver & Boyd, Tweeddale Court, Edinburgh.
E. Ponsonby, Ltd., 116, Grafton Street, Dublin.
Ernest Leroux, 28, Rue Bonaparte, Paris.
Martinus Nijhoff, The Hague, Holland.
Otto Harrassowitz, Leipzig.
Friedlander and Sohn, Berlin.

IN INDIA AND CEYLON

- Thacker, Spink & Co., Calcutta and Simla.
W. Newman & Co., Calcutta.
R. Cambay & Co., Calcutta.
S. K. Lahiri & Co., Calcutta.
B. Bannerjee & Co., Calcutta.
The Indian School Supply Depôt, 309, Bow Bazar Street, Calcutta, and 226, Nawabpur, Dacca.
Butterworth & Co. (India), Ltd., Calcutta.
Rai M. C. Sarkar Bahadur & Sons, 75-1-1, Harrison Road, Calcutta.
The Weldon Library, 57, Park Street, Calcutta.
Standard Literature Co., Ltd., Calcutta.
Lal Chand & Sons, Calcutta.
Higginbothams, Ltd., Madras.
V. Kaliyanarama Iyer & Co., Madras.
G. A. Natesan & Co., Madras.
S. Murthy & Co., Madras.
Thompson & Co., Madras.
Temple & Co., Madras.
P. R. Rama Iyer & Co., Madras.
E. M. Gopalakrishna Kone, Madura.
Thacker & Co., Ltd., Bombay.
A. J. Combridge & Co., Bombay.
D. B. Taraporevala, Sons & Co., Bombay.
Mrs. Radhabai Atmaram Sagoon, Bombay.
Sunder Pandurang, Bombay.
Gopal Narayan & Co., Bombay.
Ramchandra Govind & Son, Kalbadevi, Bombay.
A. H. Wheeler & Co., Allahabad, Calcutta and Bombay.
N. B. Mathur, Superintendent, Nazir Kanun-i-Hind Press, Allahabad.
Rai Sahib M. Gulab Singh & Sons, Mufid-i-Am Press, Lahore.
A. Chand & Co., Lahore, Punjab.
Ram Krishna & Sons, Lahore.
Superintendent, American Baptist Mission Press, Rangoon.
Manager, the "Hitavada," Nagpur.
S. C. Talukdar, Proprietor, Students & Co., Oooch Behar.
A. M. & J. Ferguson, Colombo, Ceylon.
Manager, Educational Book Depôts, Nagpur and Jubbulpore.*
Manager of the Imperial Book Depôt, 63, Chandney Chauk Street, Delhi.*
Manager, "The Agra Medical Hall and Co-operative Association, Ltd." (Successors to A. John & Co., Agra.)*
Superintendent, Basel Mission Book and Tract Depository, Mangalore.*
P. Varadachary & Co., Madras.*
H. Liddell, Printer, etc., 7, South Road, Allahabad.*
D. C. Anand & Sons, Peshawar.*
Ram Dayal Agarwala, 184, Katra, Allahabad.*
Manager, Newal Kishore Press, Lucknow.*

* Agents for the sale of Legislative Department Publications only.

CONTENTS

(VOL. XVIII, PART III)

ORIGINAL ARTICLES

	PAGE
SOME COMMON INDIAN BIRDS. NO. 21. THE COMMON MYNAH (<i>Acridotheres tristis</i>)	199
<i>T. Bainbriggé Fletcher, R.N., F.L.S., F.E.S., F.Z.S.; and C.M. Inglis, M.B.O.U., F.E.S., F.Z.S.</i>	
THE RÔLE OF PLANT PHYSIOLOGY IN AGRICULTURE	204
<i>Gabrielle L. C. Howard, M.A.</i>	
THE VALUE OF FERMENTED GREEN MANURES AS TESTED AT PUSA BY THE PREVALUED PLOT METHOD	219
<i>C. M. Hutchinson, C.I.E., B.A.</i>	
UNAVOIDABLE ERROR OF FIELD EXPERIMENTS ..	238
<i>O. T. Faulkner, B.A.</i>	
MILL TRIALS OF SELECTED COIMBATORE SUGAR- CANE SEEDLINGS	249
<i>Wynne Sayer, B.A.</i>	
THE FIFTH ENTOMOLOGICAL MEETING ..	257
A NITROGEN METABOLISM STALL FOR BULLOCKS	267
<i>F. J. Warth, M.Sc.</i>	
THE WEALTH AND WELFARE OF THE PUNJAB: A REVIEW	272
<i>A. C. Dobbs</i>	

SELECTED ARTICLE

COTTON FROM THE GEZIRA: PROGRESS OF BLUE NILE SCHEME ..	281
---	-----

NOTES

THE DETERMINATION OF THE TRUE STAPLE LENGTH OF INDIAN COTTONS	287
PROPAGATING THE SUGARCANE—SUCCESS FOR INDIAN METHODS IN CUBA	289

	PAGE
TESTING SPINNING VALUE OF COTTON	290
SOME PHYSICAL MEASUREMENTS ON COTTON FIBRES AND THEIR GRAPHICAL REPRESENTATION	293
COTTON RESEARCH	294
A STUDY OF FLAX AND KINDRED FIBRES	296
A NEW PRINCIPLE IN PLOUGHING AND ROAD SURFACING AND ICE SURFACING	297
JOURNAL OF THE EMPIRE COTTON GROWING CORPORATION ..	299
PERSONAL NOTES, APPOINTMENTS AND TRANSFERS, MEETINGS AND CONFERENCES, ETC.	303

REVIEWS

PRINCIPLES AND PRACTICE OF BUTTER MAKING	307
FARM BUILDINGS	308
NEW BOOKS ON AGRICULTURE AND ALLIED SUBJECTS ..	309
LIST OF AGRICULTURAL PUBLICATIONS IN INDIA FROM 1ST AUGUST, 1922 TO 31ST JANUARY, 1923	311

LIST OF ILLUSTRATIONS.

The Common Mynah (<i>Acridotheres tristis</i>)	Frontispiece
	Facing page
Plate IV. General view of Co 13 sugarcane grown without irrigation at Pusa	252
„ V. Fifth Entomological Meeting, Pusa	257
„ VI. A bullock in stall with an apparatus for collecting urine	267
„ VII. Feeding trough stall	268
„ VIII. Hair length determinations of Jalaun No. 1, Cawnpore	287
„ IX. Hair length determinations of the Burma Wagyi, card sliver	288
„ X. Sledge sorter efficiency tests: Frequencies of cotton hair lengths	289
„ XI. The spiral-cutter plough	297

**The following Original Articles will appear in our next issue
(July 1923).**

- SOME COMMON INDIAN BIRDS. No. 22. THE
 INDIAN HOUSE-CROW (*Corvus splendens*) -- T. Bainbrigge Fletcher,
 R.N., F.L.S., F.E.S.,
 F.Z.S.; and C. M. Inglis,
 M.B.O.U., F.E.S., F.Z.S.
- THE CATTLE PROBLEM OF THE UNITED PRO-
 VINCES -- -- H. M. Leake, M.A., Sc.D.,
 F.L.S., M.L.C.
- TECHNOLOGICAL RESEARCH ON RAW MATERIALS
 AND ITS RELATION TO PLANT BREEDING .. B. C. Burt, M.B.E., B.Sc.
- NOTE ON THE USE OF *Cholum* (*Sorghum Vulgare*)
 IN MALTING Roland V. Norris, M.Sc.,
 A.I.C., D.Sc.; and B.
 Viswanath.
- THE SECOND VETERINARY CONFERENCE,
 CALCUTTA



THE COMMON MYNAH (*ACRIDOTHERES TRISTIS*)

Original Articles

SOME COMMON INDIAN BIRDS.

No. 21. THE COMMON MYNAH (*ACRIDOTHERES TRISTIS*).

BY

T. BAINBRIGGE FLETCHER, R.N., F.L.S., F.E.S., F.Z.S.,

Imperial Entomologist ;

AND

C. M. INGLIS, M.B.O.U., F.E.S., F.Z.S.

THE Common Mynah needs little introduction as it is of common occurrence in every garden throughout India. "Neat but not gaudy" seems to be its motto as it goes through life in its decorous, but by no means dingy, colouring of black, brown and white, finished off with a bright yellow beak and legs and a yellow patch behind the eye. The wings are black, with a white bar which is most conspicuous during flight, when, according to Lockwood Kipling, "a curious effect of rotation" is produced. The head, neck and upper part of the breast are also black, as are the tail-feathers, which have broad white tips also especially conspicuous during flight. The rest of the plumage is brown. Occasionally colour variations occur and albinos are not very rare and Finn records examples with pale cinnamon body-plumage; for some time there was an individual in my compound with a bright yellow head—possibly due to moulting. The two sexes are coloured alike but the hen is slightly smaller, the cock bird having a larger head and more massively built body. The Common Mynah, as represented on our Plate and found throughout India

and Burma, is the typical form, the Ceylon race (*Acridotheres tristis melanosternus*), representing a subspecies which differs in being darker and in having the outer webs of the earlier primary-coverts black. South Indian examples are darker than those from Northern India.

As is expressed by its generic name, *Acridotheres*, which means a grasshopper-catcher, the Common Mynah is mostly a ground-living bird, pacing about in open spaces, and especially over grassy lawns, on the hunt for grasshoppers and other insects. Like the Cattle Egret, it is a constant attendant upon cattle, following the animals and catching the insects disturbed by their movements. For the same reasons, it is greatly interested in cultural operations, such as ploughing or the cutting or irrigation of crops, as such occasions provide a rich harvest of insect prey. The insects eaten by this bird are practically all of injurious kinds—grasshoppers, crickets, caterpillars and beetle grubs for the most part—but the Mynah is a very general feeder and spiders and worms are eagerly sought for and devoured, whilst grain and fruits lend variety to its diet. The fruits eaten are mostly wild figs and no great toll is levied on cultivated fruits. Cereals, however, are sometimes attacked to some extent and some little damage is done at times, especially to maize which is preferred whilst the seeds are still soft and unripe. As in the case of many other useful birds, however, it is necessary to take a broad view and not grudge a small toll levied on cultivation in return for the great assistance rendered throughout the year in reducing insect crop-pests.

In his *Birds of the Plains*, Dewar calls the Mynah “a bird of character,” and such undoubtedly it is, standing no nonsense from other birds, whether of its own or of other species. A pair of Mynahs, accustomed to quarter a restricted patch of lawn for insect prey, will strongly resent intrusion on their hunting ground by any other bird and will rigorously put into practice an unwritten notice that “Trespassers will be prosecuted.” As Finn puts it, “Bold, vigorous and pushing, he secures to himself a large share of all good things in the way of insects and fruit that may be going, and is a bird of remarkable all-round abilities, though not particularly

graceful in his movements." Few birds dare stand up to a Mynah and there are very few birds that a Mynah will hesitate to assault. For this reason, the Mynah has not proved an altogether unmixed blessing in those countries to which it has been introduced from India as it is too powerful and too free a breeder to be allowed to increase without checks and thus often renders itself a nuisance by its aggressive habits towards other, not less useful but less pugnacious, birds. It has been introduced from India into Mauritius, Australia, New Zealand, and Hawaii and in the last mentioned locality has shown itself a decided nuisance by turning out pigeons. In the Andamans also, whither it was introduced in 1873, it seems to be doing its best to oust the pretty little native white Mynah (*Sturnia andamanensis*). It was introduced into Mauritius to destroy grasshoppers and was abundant and perfectly naturalized around Port Louis when I was there in 1905.

In spite of his assertive nature, the Mynah is an extremely interesting acquaintance, as his very boldness makes his actions easy of observation whilst his universal occurrence provides endless opportunities of watching his happy habits. Unlike the crow, with its furtive and self-conscious manner, the Mynah makes itself thoroughly at home and at its ease around or even in a human habitation, where its actions seem to be always perky and devoid of any sense of shame. Indeed, as Cunningham aptly says, Mynahs "always make themselves entirely at home in a house, taking it completely for granted that they are quite at liberty to drop in and stay whenever and for as long as they like." Sometimes, indeed, they make themselves rather too much at home, as when they insist on nesting in some convenient hole in a house and litter the surroundings with a miscellaneous collection of nesting materials. Here again we may quote from Cunningham's excellent account of a pair of Mynahs which helped to while away the hours of his first hot weather in Calcutta:—"He and his wife had elected to place their nest on the cornice beneath the beams in one corner of the open roof of my room, and were constantly coming in with fresh stores of building materials. It was quite refreshing to see the supreme satisfaction that they derived from the progress of their work—a

satisfaction that every now and then became so acute as to call for a short rest and jubilant little song. Merely to watch the construction of a mynah's nest is a liberal education ; it is like watching the steps in the formation of a local museum. Their taste in materials is so catholic that one never knows what curio may not be brought in. Sticks, straws, feathers, rags, small bones, and pieces of paper are all deemed valuable, and a very special worth would seem to attach to the cast skins of snakes, for, in any case where these are attainable, they are almost sure to be worked into the growing heap of rubbish. The pity is that in their effort to bring in exceptionally bulky materials they are apt to drop them about, and, although snake-skins and feathers may be interesting and even decorative additions to the furniture of a room, great pieces of paper or rag, of unknown origin and very doubtful purity, can hardly be regarded as very desirable additions to one's surroundings."

The nest, as may be gathered from the preceding, is an untidy mass of dry grass and miscellaneous rubbish, usually warmly lined with feathers, and placed in a hole, where this is available, either in a tree or in the wall or roof of a house. Sometimes it may be placed in creepers growing on a wall, or on any sheltered ledge, occasionally in palms or other trees. The nesting season lasts from the beginning of the hot weather until well on in the South-West Monsoon. As a rule, four or five eggs are laid and these are of a glossy bright blue colour, about 30 mm. by 21.5 mm. Mr. C. M. Inglis has on one occasion taken a Koel's egg from a nest of this species which also held three of the Mynah's own eggs ; this is, of course, exceedingly unusual. The young are fed mostly on an insect diet consisting of caterpillars, beetle grubs, grasshoppers and crickets, varied by occasional worms and soft fruits.

Mynahs are of course often kept as cage-birds and birds which are reared up from the nest become very tame and fearless. The Common Mynah is a good mimic also, although not able to acquire such a wide range of vocabulary as the Grackles or Hill Mynahs. Normally, it is rather a noisy bird, its song, to be heard throughout the day, comprising a strange mixture of harsh gurglings and liquid

notes. E. H. Aitken described its notes as “ *Keeky, keeky, keekychurr, churr, kok, kok, kok* ” and these sounds are fairly descriptive. As it utters the *kok, kok, kok*, it bobs its head in a characteristic manner. When a small flock is feeding on the ground and one bird sees cause for alarm, it takes to wing with a shrill cry of alarm to its fellows. As a rule, such small flocks seem to consist of two or more individuals, generally a cock and hen and their family. Mr. C. M. Inglis has on one occasion seen this Mynah feeding the young of the Pied one. During the off-season for nesting, however, they often congregate in large flocks in the evening to roost in company on favourite trees providing dense leafy cover and at such times the deafening din that arises is quite ear-splitting, as every bird seems to have to argue about its proper perch and then to proceed to gossip at the top of its voice about the events of the past day. During February, when the silk cotton (*Bombax malabaricum*) trees are in flower, like flying-foxes and many other birds, they are very fond of the liquor that is to be found in the lower part of the large red flowers, and the competition for this often creates a prodigious fuss almost equal to that at roosting-time.

The Common Mynah has many vernacular names in India. It is known as *Maina* or *Desi-maina* in Hindi, as *Salik* or *Bhat-salik* in Bengali, as *Bemni* and *Salu* in Chota-Nagpur, as *Salonka* in Mahratti, as *Gorwantera* in Kanarese, as *Goranka* and *Gorinka* in Telugu, and *Zayet* in Burmese, while in the Central Provinces there is a local name *gulgul*, of which *gurral* in the Punjab is apparently another form. In Hindu mythology the Mynah is sacred to the God Ram Deo and sits on his hand. In local stories and talk this bird is also a favourite.

The Common Mynah is protected by law throughout the year in Bombay, the United Provinces, Delhi and Bengal, and in Burma for trade purposes in reserved forest areas. In Mysore it is presumably protected under the heading, “birds of song, absolutely.” On the whole, in India at all events, it seems to be a decidedly useful bird.

THE ROLE OF PLANT PHYSIOLOGY IN AGRICULTURE.*

BY

GABRIELLE L. C. HOWARD, M.A.,
Second Imperial Economic Botanist

I WISH to take the opportunity, provided by this address, to bring before you a branch of botany which offers a wide and interesting field of work. As the immediate need, when agricultural investigation was started in India, was for better varieties, that aspect of agricultural botany which deals with the improvement of crops is being extensively developed. New varieties have been produced by selection and by hybridization. The laws of inheritance are under investigation as well as the details of pollination and their bearing on the principles underlying seed distribution. While there can never be too many workers on the improvement of crops, I think the time has come when the claims of another side of agricultural botany, namely, physiology, should be emphasized. This seems a fitting occasion to bring physiological problems forward because they are well adapted to workers who are provided with laboratory facilities and a garden, but have not at their disposal the resources of an experimental farm. Investigations in plant breeding require an ever increasing amount of land and labour and many years of uninterrupted, time-consuming work. Further, if the results are to be of practical importance, the investigations must be continued in one locality. If economic developments are to be achieved, a large organization like that of an agricultural department is required to test and distribute the new variety. On the other

* Presidential address, Section of Botany, Indian Science Congress, January 1922.

hand, the physiological interpretation of agricultural practices can be pursued with much smaller means as regards land. They are not so dependent on the locality or the season and can be carried on intermittently, a great advantage where research is only one of the duties of an individual. Such investigations not only bring the worker into touch with some of the most intricate scientific questions but also into contact with the living plant and with the practical problems of Indian agriculture.

In agriculture, the plant is the centre of the subject. It is the visible, living agent by which the materials provided by the soil and the atmosphere can be utilized for the service of man. This fact is not always vividly realized. Modern developments in agricultural chemistry and bacteriology have brought the soil into prominence and tempt us to consider it as the active agent rather than the plant. For instance, it is customary to speak of "the soil producing a crop" or "the land yielding its increase." Attention is sometimes too exclusively concentrated on the condition of the soil without sufficient consideration of the roots which are to use it. Arable farming is the endeavour of the farmer to make the conditions such that the plant will do what he wishes. His effort is to please the plant. The application of manure and the whole of the operations connected with tillage, which involve an immense amount of labour and thought, are carried out with the object of preparing food materials and a habitat for the plant so that the latter may manufacture the products desired. The agriculturist is the servant of the plant. If he does not provide a comfortable domicile, properly drained and aerated, with adequate food materials and water, the plant retaliates by giving a poor return. In addition, the proportion of the various products yielded, namely, green vegetable matter, seed and fibre, depends on the environment. The agriculturist, therefore, becomes master of the plant when, by modifying the external conditions, he can make it yield the largest possible quantity of the particular product desired. The soil can be directly influenced by the agency of man by means of irrigation, aeration, cultivation and manuring. With the exception of mutilations, such as pruning, the plant can only be controlled through its environment.

EFFECT OF CHANGES IN THE ENVIRONMENTAL CONDITIONS ON THE NATURE AND QUALITY OF THE PRODUCE.

I will give a few examples of the determination of the nature of the produce by the environment. Table I shows the effect of over-irrigation on the relative yield of straw and grain in the case of wheat.

TABLE I.

*Yield of wheat with varying quantities of irrigation water.*¹

Inches of irrigation water applied	Bushels of grain to the acre	Pounds of straw to the acre	Pounds of straw for each bushel of grain	Bushels of wheat for each inch of water
5.0	37.81	2,986	79	7.56
7.5	41.54	3,301	75	6.39
10.3	43.53	3,452	79	4.35
15.0	45.71	3,954	87	3.05
25.0	46.46	4,311	93	1.86
35.0	48.55	4,755	98	1.39
50.0	49.38	5,332	108	0.99

¹ Widstoe. *Principles of Irrigation Practice*, 1914.

It will be seen from the figures in the fourth column that raising the amount of irrigation water from five inches to ten increases the yield of straw and grain in equal proportions. Further additions of water give a greater proportion of straw. The fact that the actual amount of grain increases all the time shows however that the limit of grain production has not been reached. The physiological reason why over-irrigation should stimulate one form of growth rather than another remains to be discovered.

The fact that heavy nitrogenous manuring often *increases* the vegetative growth and *decreases* the amount of seed is an interesting example of the effect of environment on the type of produce. Under such circumstances, a large amount of weak, sappy growth without a corresponding increase in the amount of seed is generally produced. The evil effects on wheat are well marked in this country. With excess of nitrogen, a very leafy crop with weak straw is obtained which easily lodges and is very liable to rust. Maturity is delayed and the hot winds dry up the plant before the grain can fill. In

this case, as in many others, the depressing effect of a large supply of nitrogen on the yield of seed is partly due to the prolongation of the vegetative phase by excessive growth stimulation. This rapid growth also prevents the laying down of those substances like silicates which give strength to the straw. Many cases of reduction in the yield of seed can be explained by delayed maturity but this does not seem to be the only factor. The character of the growth also alters.

The following table shows the relative percentage increase in vegetation and seed produced in some leguminous crops by an addition to the nitrogen content of the soil. Delayed maturity was not a factor in this experiment. It will be seen that not only does the effect on the seed and green parts of the plant differ but these three crops are markedly dissimilar in their reaction to the manurial treatment. The experiments were carried out in small pit cultures¹ and have been confirmed in subsequent years.

TABLE II.

The effect of organic manure and sodium nitrate on the yield of some leguminous crops.

	INDIGO 1918-19			GRAM 1918-19			SWEET PEAS 1918-19		
	Dry weight in grammes		Ratio	Dry weight in grammes		Ratio	Dry weight in grammes		Ratio
	Veg.	Seed	Veg. Seed	Veg.	Seed	Veg. Seed	Veg.	Seed	Veg. Seed
CONTROL	68	32	2.19	719	409	1.76	994	259	3.84
ORGANIC MATTER									
Well rotted leaf mould 10 per cent. by volume	1,158	403	2.87	2,175	535	3.99
30 " " " "	907	577	1.56	1,136	361	3.14	2,201	526	4.19
50 " " " "	1,276	421	3.03	2,351	525	4.48
SODIUM NITRATE									
2 cwt. per acre	1,170	627	1.87	1,190	398	2.99
4 " " " "	1,127	651	1.76	1,215	356	3.41
8 " " " "	191	115	1.66

¹ Howard, A., and G. L. C. Some methods suitable for the study of root development. *Agr. Jour. of India*, Special Indian Science Congress Number, 1918.

The converse result, namely, an increase in seed obtained by withholding nitrogen from a tomato crop is shown in Table III. The experiment was carried out at the Cheshunt Experiment Station in Great Britain.

TABLE III.

*The effect of withholding nitrogen on the yield of tomatoes.*¹

	Lb. per plant				Tons per acre				Relative weights
	1916	1917	1918	1919	1916	1917	1918	1919	Average 1916-1919
Complete artificials ..	4.9	5.11	3.32	5.57	38.7	35.8	25.8	42.2	100
No nitrogen ..	5.7	5.60	3.62	5.98	45.0	39.2	28.2	47.4	111

¹ Russell, E. J. *Soil Conditions and Plant Growth*, 1921, p. 62.

There are a large number of other problems connected with the nitrogen metabolism of plants which would well repay study and many of these have an agricultural bearing.

The question of quality offers a further field of investigation in connection with the effect of change of environment. Quality in produce is generally associated with definite localities and such a reputation is one of the greatest agricultural assets a place can have. I need only mention the champagne districts of France and certain tea districts. Choice of variety does not always explain the matter. The cause lies in the environment as well but so far it has not often been possible to prove association with any particular property of the environment. Quality is generally dependent on good development and sharp ripening. It has been suggested that it may be depressed by poor soil aeration, which delays maturity. The fact that it not only varies with the locality but also with the season would point to some such factor being involved rather than the chemical composition of the soil. Fig. 1 shows one variety of groundnut grown under the same rainfall on the well-aerated *bhata* soils of the Central Provinces and on heavy black soil. The nut

grown on the *bhata* soil in addition to being much bigger was better in taste and texture.



FIG. 1. Groundnut grown on (a) bhata soil, (b) black soil.

Good aeration seems also to influence the flavour of fruit. Thus over-irrigation of peach trees in the Quetta valley produces tasteless fruit which does not travel well. No definite investigations have yet been carried out on the relation between aeration and quality but if the secret of good quality could be found even in a few cases the economic advantage would be great.

I have said enough to show how small our knowledge is and how many problems there are connected with the effect of change in the environmental conditions on the yield and quality of agricultural produce.

INTERPRETATION OF FIELD EXPERIMENTS.

The interpretation of field experiments is the second direction in which plant physiology can be of assistance to agriculture. We have seen that a knowledge of the reaction of the plant to its environment is essential if the farmer and not the plant is to be the master of the situation. To acquire such knowledge is one of the aims of agricultural investigation. It can be obtained empirically by the method very frequently used, namely, by observing the effect on

the outturn of successive changes in the environment. The effect of various manures, modes of cultivation and additional irrigation on the yield of seed are good examples. Such experiments, when carried out under agricultural conditions, are known as field experiments and anyone who has experience of field experiments knows how exasperating they are. It is one of the most difficult things in the world to obtain really conclusive and reliable results. Climatic conditions cannot be controlled, some of the soil factors are uncertain and the results in succeeding years have a most annoying habit of being contradictory. The scientific man trained in the exact habits of laboratory investigation, where conditions can be regulated, is apt to be sceptical and to lose patience. Nevertheless, to obtain results which are economically sound and to test the conclusions of the laboratory, field experiments¹ are essential. Here there is great scope for the botanist. In such experiments we are apt to focus attention on the beginning and the end only, that is, on the conditions provided and the yield obtained. We tend to ignore the changes and processes which have been taking place in the plant. This is, in reality, a selfish and brutal method of dealing with the subject. If we focus our attention on the plant and instead of regarding it as a machine which grinds out so much food for us we look upon it as a living individual completing its life cycle under certain conditions, we obtain valuable information even from an experiment in which the end result is rendered useless by some climatic circumstance. Results which seem contradictory often become clear. I will illustrate my meaning by two examples. The classic instance is the explanation of the nitrogenous nutrition of leguminous plants. For many years, scientific agriculturists had been perplexed by the difference between the *Leguminosæ* and other plants in their reaction to nitrogenous manuring. It was not until

¹ Great efforts have recently been made to improve the technique of field experiments by calculating the probable error, by paying great attention to the shape and size of the plots and by the use of the method known as the chess board system, but all these devices, though they eliminate errors due to unevenness of soil, cannot deal with climatic variations. Moreover, the immense amount of additional labour and supervision required limits their execution and useful-

the part played by the root nodules was discovered that these contradictory results could be explained. A similar example arose in the course of some work at Pusa. Indigo wilt, the subject of the investigation, had been shown to be due to the death of the active roots and nodules. Bad soil conditions induced by the monsoon and the rise of the sub-soil water were the chief contributing causes. The most promising remedy appeared to be improvement of the aeration and soil conditions by cultivation. Cultivation of all kinds in the hot weather and very early rains is of immense benefit to indigo. Various methods were tried in the monsoon but all were a failure. Many plants died and the remainder grew less rapidly than those in the non-cultivated plot. The same results were obtained in the following year. Apparently aeration benefited the plant in the hot weather and very early rains and positively harmed it at the end of the monsoon. The beneficial effect of cultivation was again obtained in the cold weather. An examination of the root system gave the explanation of these apparently contradictory results. In the hot weather the active roots of indigo are distributed through a considerable depth of soil. About the middle of the monsoon the lower roots die and the plant lives entirely on those which lie near the surface. Cultivation during the hot weather does not cut many of the active roots. Cultivation during the late monsoon practically deprives the plant of the greater part of its active root system. Some of the plants never recover. The others have to make a new root system before they can grow. The contradictory results on the effect of aeration were therefore at once explained by the examination of the root system. Similar observations have also given practical indications as to the best time for cultivating monsoon crops. In Bihar the growth period of *patwa* (*Hibiscus cannabinus*), sunn hemp, indigo and *arhar* (*Cajanus indicus*) is prolonged through the monsoon into the cold weather. The temptation at the end of the monsoon is to break up the rain-sodden ground as soon as possible and to ameliorate the soil conditions. To do this with surface-rooted plants does more harm than good. Deep cultivation should be delayed until the drying of the ground and the fall of the sub-soil water has enabled

the plants to make a deeper root system. The sudden death after the monsoon of full-grown plants which previously appeared in good condition was also explained by a change in the active root system. Indigo wilt and other wilt diseases commonly make their appearance during the latter part of October and November at a time when all the conditions are most favourable for growth. The plants survive the monsoon, appear healthy in the early part of October and then unaccountably die. Such plants were found to have developed a very superficial root system. While the soil was moist they thrive. When the surface soil and air became dry in November they could not absorb enough water to make good the loss by transpiration and wilted before they could form new roots. Experiments were carried out in which the soil round certain old indigo plants was kept moist by covering it with dried grass. In all cases these plants survived while many of their neighbours died.

The benefit to be obtained from a continuous examination of the plant during the course of an experiment is more difficult to illustrate but is not the less important. Its usefulness has been brought home to me by actual experience. Very great difficulties have been encountered while carrying out field experiments in a place close to a silt-bearing river which has continually changed its course in the past and where incipient alkali formation is common. The soil and especially the sub-soil vary greatly—often in the same field. Really reliable field experiments, except on very small plots, are therefore out of the question. Had the end results only been considered, namely, the yield—work would have been impossible. In making the study of the plant, the main object during the course of the experiment, the great possibilities of this line of study have become apparent. The plant is so sensitive and reacts so quickly to every alteration in the environment that it is an excellent indicator of changes taking place in the soil. Critical examination of the crop during the investigation has often revealed the existence of some limiting factor which was affecting the results, for instance the existence in certain portions of the field of a hard pan far below the level of cultivation. Another illustration may be given from some manurial experiments on tobacco. The experimental conditions

were apparently perfect but it was noticed that in one corner of the field the plants were poor. Exploration of the sub-soil showed that a layer of sand passed under the land at a depth of three to four feet. The water from the flooded rice fields, which were just below the experimental area, passed up through this sand and water-logged that particular corner. Had the yields given by the various plots only been considered this would have led to false conclusions as to the effect of the manurial treatment.

The plant should be used as an interpreter of agricultural conditions to a very much greater extent than it is, but to do this much deeper knowledge than we now possess is required. It is true that a certain amount of knowledge already exists. We know that when a plant wilts in the day and recovers at night it is losing more water than it can absorb. We can also go further than that for we know that lucerne and other plants require water when they begin to show a peculiar blue green colour in the leaves. This takes place long before any sign of wilting can be observed. Tobacco plants indicate that the aeration of the soil is defective by the leaves assuming an upright position. If the crop is deeply cultivated, the leaves relax and spread out, thus allowing a greater amount of assimilation and more rapid growth. We know by experience that this is so, but we do not know the reason why bad aeration should influence the set of the leaves. Instances could be multiplied in which very slight changes in the appearance of the leaves give valuable indications of the soil conditions affecting the roots. We require, however, more knowledge and more fundamental knowledge of the relation between the different parts of the plant. For such investigations the agricultural plant physiologist requires a vivid mental picture of the plant as a living whole. It is as much a biological unit as an animal. The latter, however, is visible as an entity and acts as an entity. If we injure any portion of it, we expect reaction and disturbance of the whole. In the plant our mental conception is blurred by the fact that one of the most important structures is underground. We do not treat it as an entity, for we continually mutilate it without troubling very much about the effect on the remaining portion.

AGRICULTURAL PRACTICES WHICH ARE MUTILATIONS.

This brings me to another class of investigations, namely, the effect on the metabolism of the plant of those agricultural processes which are really mutilations. The cutting of green fodder, the plucking of tea, the pricking of the poppy capsule, the grafting and budding of fruit trees, root pruning and the grazing of young wheat are examples. One of the most interesting of these is the frequent reaping of fodders like lucerne. Here extremely rapid growth is induced and when the growth is almost completed or even when it is at its height, the whole of the upper portion is cut off. This operation must produce a most profound disturbance in the metabolism of the plant. The entire supply of carbohydrate material is suddenly removed while the full complement of roots with their power of absorption of water and salts and their need for carbohydrates is left. How does the plant adapt itself to this tremendous change? Apparently, it does not suffer, for green shoots are very soon produced again and the mutilation can be repeated many times during the year. What is, however, the effect on the roots? Interesting information on this point was obtained in the case of indigo which is treated in much the same manner as lucerne. If the roots of indigo are carefully exposed by a spraying machine a few days after the crop has been cut back, it will be found that at least half the active root system and all the nodules have been killed. The plant then slowly makes a new root system and finally shoots. If very young plants with thin stems are cut back, they are unable to repair their root system and the plant dies. Older plants with thick woody stems survive. Fewer roots are killed and the plant shoots more rapidly if a side branch with two or three leaves is left at the time of cutting. It would be interesting to know to what the death of the roots is due. Is it caused by starvation from lack of carbohydrates? The fact that the individuals with thick woody stems, that is, with reserves to draw upon, survive, would point to this being a factor. On the other hand, the assimilation of the few leaves left after cutting back seems hardly sufficient to account for the beneficial effect. Is it due to the sudden dislocation of the transpiration current? Considering how many

agricultural processes are really mutilations and how often we employ mutilation to increase fruit formation, it would be interesting to have more exact information on the changes induced in the metabolism of the plant. Knowledge of this kind might lead to important modifications in current practices.

INCIDENCE OF DISEASE AND THE PHYSIOLOGICAL STATE OF THE PLANT.

Another very fruitful line of research lies in the relation between the incidence of disease and the physiological state of the host plant. As a very interesting paper by Dr. Shaw of the Pusa Research Institute is to be read on this subject in connection with fungoid diseases, I will only give briefly two examples taken from insect pests. It has frequently been noticed that attacks of *Aphides* can be correlated with defective aeration of the roots of the host. At Quetta, green-fly is one of the great pests of the peach but it was found that only the over-watered trees suffered. Similar trees alongside which were given a minimum amount of water were not attacked. When however the irrigation was increased, such immune trees in their turn were soon covered with green-fly. A large number of specially designed experiments bore out these observations. Similar results were obtained at Pusa last year with *Lathyrus sativus*. In connection with some investigations on the cause of lathyrism, samples of this crop from various parts of India were collected. These were sown in one small plot. During the course of the season, an attack of *Aphis* supervened but it was found that only those varieties which came from the Central Provinces were badly attacked. Local varieties were untouched and those from stations between the Central Provinces and Bihar only suffered to a small extent. Examination of the roots showed that, without exception, the most susceptible varieties had deep root systems unsuited to the wet, close soils of Bihar while those immune had shallow ones (Fig. 2).

Correlation between the condition of the host and the incidence of disease has been observed in other countries. A change in the composition of the cell-sap has been suggested as the cause. This

seems a very probable explanation but only leads to the further problem of the effect of root aeration on the metabolism. Further,

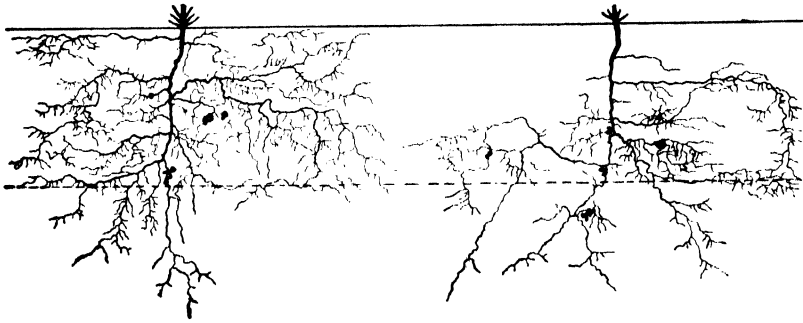

FIG. 2. Root systems of disease resistant (left) and susceptible (right) types of *khesari* (*Lathyrus sativus* L.)

is it the want of oxygen or the excess of carbon dioxide or some other factor which is the real agent ?

The fact that these two varieties of *Lathyrus sativus* possess two such very diverse root systems brings out another point. In Fig. 3 a similar difference between two varieties of linseed is to be seen.

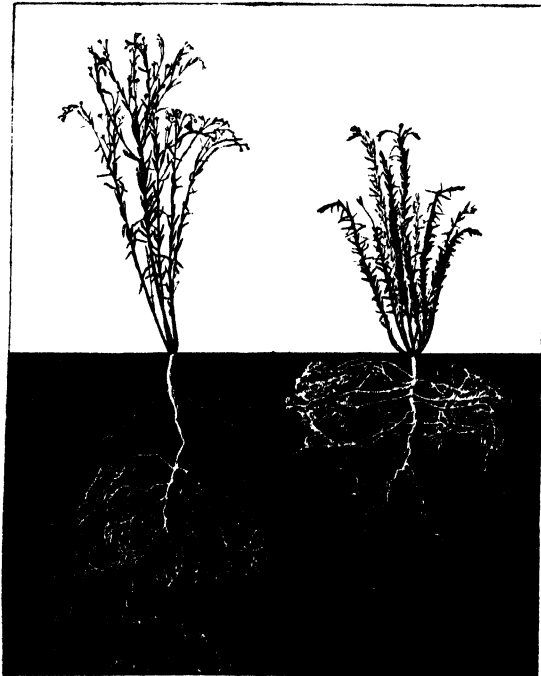

FIG. 3. Linseed from Central India (left) and the Indo-Gangetic Alluvium (right).

It is obvious that the soil requirements of these types are very dissimilar. If the physiological demands of two *varieties* are so distinct how much greater may not the difference be between two *species*. Yet in agricultural work it is not unusual to group species together as cereals, leguminous fodders and so on, and to speak as if their requirements and physiological needs were alike. Conclusions as to the behaviour of a group of plants are sometimes drawn from experiments on one variety. Many misconceptions have arisen from this habit of generalization. A third vivid conception which is necessary for work in agricultural plant physiology is therefore the recognition of the physiological individuality of species and varieties.

There are two other problems—acclimatization and change of seed—which are still unsolved although they are of fundamental importance. These can only be recommended however to those who can look forward to many years of work.

ACCLIMATIZATION AND CHANGE OF SEED.

We are all familiar with the terms acclimatization and acclimatized seed. They occur all through the literature of agricultural investigation in India and have a well-known popular meaning, but what do they really denote scientifically? I am here referring not to acclimatization of a special individual but acclimatization which produces offspring more adapted to the new climatic conditions than the original parent. Acclimatized seed is said to be and is less delicate and more suited to the locality than the seed of the same plant when first introduced. Very often the beneficial effect is due to the elimination of unsuitable types from a mixture of forms. Every year a number of the unthrifty individuals die out and the remainder give less seed than those which suit the environment. Thus the acclimatized seed does better than the freshly imported. A change in appearance is produced if the imported seed is a mixture of types morphologically different. One of the first problems we were asked to solve in India was the alleged change of white wheat to red in certain places. It was found on examination that all the samples of white wheat contained a very small percentage of a pale

red kind which happened to suit the new locality and gradually ousted the white. Cross-fertilization is another fruitful source of change of type in acclimatization. The individuals composing the mixture may be heterozygotes or heterozygotes may develop during acclimatization. Further, the mixture may consist of types not apparently morphologically dissimilar but differing in their root systems or in their physiological attributes such as earliness and immunity to disease. In this case we may secure a benefit from acclimatization without change of type. Is there any acclimatization effect beyond this ?

Change of seed is another aspect of the same subject. It is well known that some crops such as certain varieties of sugarcane and potatoes when grown for several years in the same locality deteriorate and the original benefit of the introduction is lost. If sets from these deteriorated plants are grown for one season in a colder climate and then brought back, the original vigour is restored. This practice is followed in Java with sugarcane and in the plains of India with potatoes. There seems no doubt about the facts. No explanation of hybridization or mixture can apply as the reproduction is vegetative. In both cases large amounts of reserve material are laid down. Does the explanation lie in the fact that the hot climate prevents the accumulation of this reserve material in a certain quantity or in a certain form or is some climatic influence on the enzymes involved ? Both these factors have been suggested as the explanation. This question is interesting and important and very little has been done as yet to elucidate it.

I hope I have said enough to show how wide and interesting a field there is in the interpretation and modification of agricultural practices by the application of a knowledge of the biology and the physiological processes of plants.

THE VALUE OF FERMENTED GREEN MANURES AS TESTED AT PUSA BY THE PREVALUED PLOT METHOD.

BY

C. M. HUTCHINSON, C.I.E., B.A.,
Imperial Agricultural Bacteriologist.

THE use of field experiments as a check upon chemical analyses of soils has always been recognized to be of prime importance as a means of determining the probable value of any method of treatment intended to increase their fertility. The difficulty of designing and carrying out field experiments, in such a manner as to arrive at interpretations of the results obtained in which any high degree of confidence can be placed, has also been recognized ever since scientific methods have been applied to agricultural practice. In India this difficulty is specially great owing to the very high degree of variation between closely adjacent areas of soil, and, although this fact is well known not only to the scientific experts of the Agricultural Department but also to European planters and Indian cultivators, it is by no means uncommon to find records of field experiments in India the satisfactory interpretation of which has been rendered practically impossible by reason of the neglect of certain precautions in the original lay-out of the experiments, or lack of observation of important limiting factors.

The obvious importance of field experiments as a means of determining the value of certain manures for specific crops has led numerous agriculturists in India to make use of them for this purpose, but the writer's experience has been that in a large majority of cases coming within his own observation, the results obtained have led to erroneous conclusions by reason of faulty design in the experiments themselves.

This paper does not pretend to discuss the whole question of the design and interpretation of field experiments, but is merely intended to present for consideration the results obtained in the "Punjab" experimental area of the Pusa Farm in a series of experiments upon green manuring with sann-hemp (*Crotalaria juncea*). These experiments were begun in 1917 and were carried out in collaboration with the Imperial Agriculturist. The writer's first attempts to obtain field results from the use of sann as a green manure in Bihar were made in two successive years, 1912 and 1913, on a large series of half-acre plots on the Pusa Farm, and although the results obtained were gratifying as confirming his private theories on the subject, yet it was obvious that they were unreliable owing to the irregular distribution of fertility amongst the plots themselves. This irregularity showed itself not only in a high order of variation amongst the control plots, but in the obvious differences of growth in single plots. As a consequence of the failure of these experiments the Imperial Agriculturist agreed to lay out a specially selected area on the farm in quarter-acre plots, which, after careful levelling, were to be cropped for two successive seasons without any differential treatment. This method of preliminary trial appears to be the ideal one for such soil conditions as are commonly found in India and although the delay involved in obtaining results is necessarily great, yet the value of the results secured would appear to compensate fully for this objection.

It will be seen from the table of returns (Table I) from the *rabi* (winter) crops of oats in 1915-16 and 1916-17—the plots being fallowed during the *kharif* (monsoon) seasons 1916-17—that very great individual differences of fertility existed amongst these apparently level and similar plots. Plot No. 23 giving 657 lb. may be compared with Nos. 22 and 24 on either hand giving 1,267 lb. and 1,643 lb. respectively. Similarly No. 28 gave 1,795 lb. whereas Nos. 27 and 29 gave 1,248 lb. and 1,103 lb. Similar differences occurred in these plots in the following year, and they were consequently cut out of the experimental series.

Let us, however, imagine the result of an experiment in which some agriculturist, anxious to ascertain the value or otherwise of a

TABLE I.—*Green-manuring plots in Punjab field. Yield in lb. per acre.*

Preliminary Natural Fertility Test.

Plot No.	Treatment	Rabi 1915-16 Oats (grain)	Rabi 1916-17 Oats (grain)	Treatment	Rabi 1917-18 Oats (grain)	Kharif 1918 Green maize	Rabi 1918-19 Oats (grain)	Kharif 1919 Green maize	Rabi 1919-20 Oats (grain)	Kharif 1920 Green maize	Rabi 1920-21 Oats (grain)
21B	Fallow in monsoon	1,039	2,104	3 times sann-hemp fermented without superphosphate	1,485	21,091	1,168	11,457	729	9,854	511
22B	Ditto	1,267	1,943	3 times sann-hemp fermented with 3 cwt. superphosphate per acre	1,977	21,749	1,131	15,441	907	10,677	577
23B	Not in experiment	657	1,268	Not in experiment	409	Sann-hemp burnt 14,176	731	9,034	438	7,392	320
24B	Control	1,643	2,145	Control	1,049	20,861	636	9,199	737	7,228	523
25B	Fallow in monsoon	1,144	1,911	Sann-hemp ploughed in without superphosphate	1,259	20,196	690	11,088	556	11,252	460
26B	Ditto	1,259	1,945	Superphosphate alone at 3 cwt. per acre without green manure	1,185	19,261	554	15,810	649	11,170	585
27B	Control	1,248	2,306	Control	1,051	20,262	628	12,895	620	12,238	489
28B	Not in experiment	1,795	2,704	Not in experiment	2,125	27,793	1,086	14,455	905	12,630	831
29B	Fallow in monsoon	1,103	1,682	6 times sann-hemp fermented without superphosphate	1,561	29,501	1,094	14,866	510	15,112	567
30B	Ditto	1,581	2,607	6 times sann-hemp fermented with 3 cwt. superphosphate per acre	2,643	21,748	1,564	19,301	934	16,837	910
31B	Control	1,281	2,013	Control	1,022	20,960	735	12,048	599	13,141	634
32B	Fallow in monsoon	1,160	2,083	Sann-hemp ploughed in with 3 cwt. superphosphate per acre	2,080		764	13,387	762	11,416	663

manure or treatment, had happened to lay out, say, three plots to test its action, upon this piece of land. Let us suppose first that the manure was really of no value to the crop under trial, but that the experimenter had used plot No. 23 as his control and applied the manure to Nos. 22 and 24. The very large average apparent increase of yield on these two latter plots would naturally and inevitably be put down to the action of the manure and lead perhaps to the investment of a considerable sum of money in a perfectly useless treatment. On the other hand let us suppose a similar case, but one in which the manure is actually of great value to the crop. Let us suppose further that in this case the unfortunate agriculturist had happened to utilize plots Nos. 27, 28, 29 with No. 28 as his control. However sound the use of the manure in question might be, it is unlikely that the increase due to its action would overbalance or even level up the great initial inherent differences between these three plots; the result would then be a verdict against the use of the manure and a consequent loss of valuable knowledge of its suitability for this soil and crop.

It might be argued that such a method of testing the value of a manurial application is so obviously unsound as to be outside the range of actual practice; this, however, is by no means the case either in India or elsewhere, and the records of experiment stations show numerous instances of a similar nature; it is certainly true that variations of fertility amongst neighbouring plots of such a high order of difference as those given above are not commonly found, or at least observed, but that they do occur in India is well known to many, if not to all, experimenters on this subject. It has been the writer's experience to come across numerous instances of the use of manures on a large scale the value of which has been calculated, or rather guessed at from returns obtained in the manner indicated above. It is even necessary to point out the danger of working without control plots, as this has been done, and done frequently, on an estate scale, the only control made use of being a comparison between the crop return during the season under treatment and that of the same crop on the same area in a previous one. Let us take the returns from the "Punjab" experimental area

shown for the two first years *rabi* 1915-16 and 1916-17 and assume that before the second of these some manurial treatment had been applied; let us further assume that this manure was of no value to the crop or at least gave no adequate return for the outlay involved. Take any single plot such as No. 21 and observe the increase apparently due to the manurial application 1915-16—1,039 lb.; 1916-17—2,104 lb.; or, if the experiment has been on a larger scale, compare the yields over the whole area of three acres 1915-16—15,177 lb.; 1916-17—24,711 lb.; we may grant that in this case the experimenter will probably assign some percentage of the increase to the obviously more favourable conditions due to the introduction of a fallow in the second year, but in the absence of a control plot it is very likely that he will infer that much of it, if not the greater part, is due to the action of the manure. Again, the opinion might be expressed that such a method of experiment is so bad as to be improbable, but once more the writer may say that not only has this been done by men whose living depended upon their agricultural knowledge, but that results obtained in this manner have been published in scientific papers.

Another bad method of using controls may be referred to as not infrequently practised; this consists in laying out plots and taking returns from, say, the *kharif* crop as a basis of comparison between them when assessing the value of a subsequent manurial treatment of the following *rabi* crop. Plots Nos. 27 and 28 afford interesting instances of the erroneous conclusions which might be drawn by using this method, as the following figures will show:—

TABLE II.

Plot No.	Kharif 1918	Rabi 1918-19	Kharif 1919	Rabi 1919-20	Kharif 1920	Rabi 1920-21	TOTAL	
							Kharif	Rabi
27 ..	19,260	628	12,895	620	12,238	489	44,393	1,737
28 ..	20,262	1,086	14,455	905	12,630	831	47,347	2,822

It will be seen from these returns that although this method of obtaining controls is perhaps more excusable than the one previously

described, it is liable to lead to errors of such an order of magnitude as to render it of but little more use than the latter in determining the value of a manurial treatment. The figures given are also of interest as calling attention to some interesting problems connected with the probable reasons underlying the apparent evenness of fertility of these two plots when supplying plant food for the *khariif* crop as contrasted with the very marked difference between them when tested with a cold weather cereal. Want of space prevents consideration of this point in this paper, but it may be pointed out that the difference may lie in the soil moisture conditions of the two plots, such difference being brought out in the comparative drought of the *rabi* season; on the other hand, it may be due to comparative lack of some soil constituent such as phosphate, acting as a limiting factor when grain production is concerned but not so important in the case of the green fodder maize crop of the *khariif* harvest. In either event these striking figures act as a warning not to make use of *khariif* returns in judging of the relative fertility of plots under a *rabi* crop, and indeed we may extend the warning further, not to judge of the needs of any one crop by experience gained with another.

We may now turn to consideration of the value and convenience of the method of previous assessment of the relative fertility values of experimental plots as shown by the returns from those in the green manuring experiments on the Punjab area of the Pusa farm.

As stated above, the whole area was cropped with oats for two successive seasons 1915-17, being left fallow during the monsoon. It was then seen that certain plots diverged so widely from the remainder, either by reason of excessive fertility or the reverse, as to make them unsuitable for inclusion in the series; these plots, Nos. 23 and 28, were therefore cut out, although they were cropped throughout the experiment and returns from them were recorded. Three control plots were included in the series and although one of them, No. 24, had given a relatively high yield in 1915-16, this had dropped in the following season and in the first year of the experiment, 1917-18, the three plots gave very close returns (1,049-1,051-1,022 lb. grain). With the gradual decline in fertility

consequent upon continuous cropping without any manurial treatment, this close approximation fell off somewhat towards the end of the experiment, but not sufficiently to lower the value of the plots as controls upon the others under different treatments. The comparison of yields from these plots is best effected by consideration of the differences between individual plots and those control plots which they most nearly approximated to in the returns of original fertility. Comparison may then be made between these differences rather than between those of the yields from treated plots taken directly. Thus in the case of Plot 30 (6 to 1 sannhemp+super) the original high fertility of this plot as shown by the preliminary cropping in 1915-16 and 1916-17 makes it necessary to compare its subsequent yields with the control plot No. 24 rather than with either No. 27 or No. 31, or with the average of all three. It is of particular interest to note the effect on fertility, first of a monsoon fallow as shown by the great over-all increase in 1916-17 as compared with 1915-16 and secondly of the depressing effect of this increase upon the subsequent season's crop. This effect is characteristic of Pusa soils except when already in high condition or when supplied with suitable manures, and it will be noticed in the table of returns (Table I) that the general effect of the manures as shown in 1917-18 is to prevent the drop in yield below the average rather than to increase it above that of the previous season. This increase and subsequent depression of yield in these green manure experiments is the result of a monsoon fallow, but similar results can be got on these soils by other methods such as irrigation, intensive cultivation and the use of high yielding varieties of crops. These facts suggest the influence of limiting factors in the shape of one or more soil constituents, the supply of which in an available condition is easily exhausted. On the other hand, these limiting factors may include a soil condition rather than a concrete substance, this condition possibly profoundly affecting the activities of the soil bacteria and with them the fertility of the soil itself. When we come to consider later in this paper the remarkable effects of the second application of green manure to all these plots in 1921, it will be evident that they depend upon the intervention of a

limiting factor, and moreover that this latter is, in all probability, connected more closely with the condition of a soil constituent than with its mere presence.

It is not proposed in this paper to discuss the experiment in detail, but some of the conclusions arrived at from the results obtained may be pointed out as serving to illustrate the value of the method of previous testing and assessment of the series of plots, as well as to demonstrate the efficacy of the fermented green manure. The principal object of the experiment was to determine the value of green manuring with sann-hemp, used either in the ordinary way by ploughing in green or by the modified method suggested by the writer (Bulletin No. 63 of 1916), *i.e.*, after fermentation in heaps. In addition to this the value of using superphosphate in conjunction with green manure was to be tested. Experience at Pusa has shown that the use of sann-hemp ploughed in green is followed by very varying results depending upon the incidence of the rainfall, in some years producing an actual depression of the *rabi* crop. This has been shown to be due to failure of the process of bacterial decomposition of the buried crop in the soil, and the object of the method of fermentation in heaps, in place of direct ploughing in, is to ensure completeness in the early stages of this necessary fermentation. Furthermore, the fermentation method allows of the application of heavier and more concentrated doses of the rotted manure to selected areas of soil upon which a valuable revenue crop is to be raised. The value of indigo refuse or *seet* in Bihar as a manure for tobacco depends largely upon the fact that such concentration is carried out, the usual practice involving the application of this manure to somewhere near one-tenth of the area upon which the indigo crop has been raised. It should also be mentioned here that highly successful results have been obtained with various crops by the application of the fermentation method to all sorts of vegetable refuse such as mustard and *rahar* (*Cajanus indicus*) stalks and especially oilcakes; a series of experiments has been carried out at Pusa in which partial solubilization of the tricalcic phosphate of phosphatic nodules has been obtained by fermentation of oilcake and green manures in conjunction with these nodules. The preparation

of artificial farmyard manure at Rothamsted described in Vol. XXVIII (p. 398) of the "Journal of Ministry of Agriculture" appears to be a similar process depending upon activation of the bacterial fermentation by the addition of soluble nitrogen compounds. In this process straw is made use of, whereas in the case of green manures such as sann-hemp the plant itself probably contains sufficient nitrogen to satisfy, at least partially, the requirements of the organisms responsible for the fermentation. In this experiment accordingly two concentrations were made use of, 3 to 1 and 6 to 1, neither being so high as that used with indigo *seet*, for the reason that in the manufacture of the latter considerable quantities of nitrogen are lost both as nitrogen gas and as ammonia. It was expected that owing to the more available condition of the fermented sann and its concentrated application not only would the returns from its use be immediately greater, but that this superiority would be maintained for several seasons. After four years' cropping with oats and maize, with no further addition than the original treatments in 1917, as shown on the table of returns, this expectation has been fulfilled, although as might have been expected the fertility of the whole series has been allowed to drop considerably below what would normally have been retained by the use of a rotation.

Taking first a comparison between 3 to 1 (*i.e.*, sann grown on $\frac{3}{4}$ acre applied to one $\frac{1}{4}$ acre plot) fermented sann (No. 21) and sann ploughed in green (No. 25) with the average of the control plots, Nos. 27 and 31, we get the following results:—

TABLE III.

Fermented sann 3 to 1 and sann ploughed in.

Plot No.	Treatment	1917-18	1918-19	1919-20	1920-21	TOTAL	Difference from control
		Rabi					
		Oat grain lb. per acre					
21	Fermented sann, concentration 3 to 1	1,485	1,168	729	511	3,893	+ 1,006
25	Sann ploughed in ..	1,259	690	556	460	2,965	+ 78
27 } 31 }	Controls— average of ..	1,036	681	609	561	2,887

The *kharif* returns from these plots for the three seasons 1918-19-20 gave singularly even totals, being No. 21—42,404, No. 25—43,201, controls (average of two plots)—40,644 lb. maize cut green.

Thus the use of the concentrated 3 to 1 application of fermented sann gave an increase of 1,000 lb. of oat grain over the three years at the cost of one such application as compared with the return from the sann-hemp ploughed in green, this latter only securing an increase of 78 lb. over the untreated plots in the same time. It is then a matter for consideration how the cost of this operation affects its economic value in agricultural practice; this can only be determined by local conditions.

The higher concentration of fermented sann—6 to 1—gave the following returns:—

TABLE IV.

Fermented sann 6 to 1 and 3 to 1 and sann ploughed in.

Plot No.	Treatment	1917-18	1918-19	1919-20	1920-21	TOTAL		TOTAL	
		Rabi				Rabi	Difference from controls	Kharif	Difference
		Oat grain lb. per acre							
29	Fermented sann 6 to 1 concentration ..	1,561	1,094	510	567	3,732	+ 845	57,771	+ 12,106
21	Fermented sann 3 to 1 concentration ..	1,485	1,168	729	511	3,893	+ 1,006	42,402	- 3,263
25	Sann ploughed in green ..	1,259	690	556	460	2,965	+ 78	43,201	- 2,464
27 } 31 }	Controls—average of ..	1,036	681	609	561	2,887	..	45,665	..

It will appear from the above table that the higher concentration gives no increase over that obtained with the lower one so far as the *rabi* crop is concerned. The increase on the *kharif* of over 15,000 lb. of green maize, however, is very marked and may possibly present an economic return.

The true value of the addition of these large quantities of organic matter to the soil is, however, conclusively indicated when

their full effect is brought out by the inclusion of superphosphate in the treatment.

The use of superphosphate in conjunction with green manuring has for some years been recognized as of great value on the Pusa Estate. For this reason plots were included in the series to obtain further information upon the subject. In these plots the super was used alone (No. 26); in conjunction with sann ploughed in green (No. 32); and with fermented sann at both concentrations 3 to 1 and 6 to 1 (Nos. 22 and 30).

TABLE V.

Superphosphate alone and with green and fermented sann-hemp.

Plot No.	Treatment	1917-18	1918-19	1919-20	1920-21	TOTAL	
		Rabi				Rabi	Difference from control
		Oat grain lb. per acre					
26	Super only (3 cwt.) ..	1,185	554	649	585	2,973	+ 86
32	Super and green sann ..	2,080	764	762	663	4,269	+ 1,382
22	Super and fermented sann, 3 to 1 concentration ..	1,977	1,131	907	577	4,592	+ 1,705
30	Super and fermented sann, 6 to 1 concentration ..	2,643	1,564	934	910	6,051	+ 3,106
24	Control for No. 30 ..	1,049	636	737	523	2,945	..
27 } 31 }	Controls—average of ..	1,036	681	609	561	2,887	..

Plot No.	Treatment	1918	1919	1920	TOTAL	
		Kharif			Kharif	Difference from control
		Green maize lb. per acre				
26	Super only ..	20,196	15,810	11,170	47,176	+ 1,512
32	Super and green sann ..	20,960	13,387	11,416	45,763	+ 99
22	Super and fermented sann, 3 to 1 concentration ..	21,748	15,441	10,677	47,866	+ 2,202
30	Super and fermented sann, 6 to 1 concentration ..	29,501	19,301	16,837	65,639	+ 35,036
27 } 31 }	Controls—average of ..	20,504	12,471	12,689	45,664	..
24	Control for No. 30 ..	14,176	9,199	7,228	30,603	..

From the above table it will be seen that although superphosphate by itself has but little effect upon the oat crop, yet in

conjunction with organic residues the increase due to its action is considerable. Furthermore, it is clear that this latter increase rises in proportion to the amount of organic matter added to the soil, and in this combination, in which the superphosphate appears to supply a limiting factor otherwise in defect in Pusa soil, the great value of the concentration 6 to 1 dose of fermented sann becomes obvious.

The value of superphosphate used in conjunction with green manures, whether ploughed in direct or previously fermented, may perhaps be better estimated by consideration of the returns given in Table VI in which the results are shown as direct comparisons between plots with super and those without.

TABLE VI.

Green manuring with and without superphosphate.

Plot No.	Treatment	1917-18	1918-19	1919-20	1920-21	TOTAL	
		Rabi				Difference from controls	
		Oat grain lb. per acre				Rabi	Kharif
25	Sann ploughed in green	1,259	690	556	400	+ 78	- 2,463
32	Sann ploughed in green with 3 cwt. super ..	2,080	764	762	663	+ 1,332	+ 99
21	Fermented sann, 3 to 1 concentration ..	1,485	1,168	729	511	+ 1,006	- 3,262
22	Fermented sann, 3 to 1 concentration and super ..	1,977	1,131	907	577	+ 1,705	+ 2,202
29	Fermented sann, 6 to 1 concentration ..	1,561	1,094	510	567	+ 845	+ 12,117
30	Fermented sann, 6 to 1 concentration and super ..	2,643	1,564	934	910	+ 3,106	+ 53,036

Here the influence of the super upon the yield is very obvious when used in conjunction with organic residues, these results being in marked contrast with the returns from super alone (Table V). It will be noticed that a feature of the action of super on these soils is the rapid falling off in the initial increase resulting from

its use (Nos. 21 and 22) except where this latter is maintained by the presence of large amounts of organic matter as in No. 30. It must be remembered that although no further additions of manure or materials were made to these plots after the initial applications yet some allowance must be made for the cumulative effect of the root residues remaining in the soil after each season's cropping; these would naturally be greater in amount and consequently in cumulative effect, in those plots bearing the heavier crops. It is therefore necessary to emphasize the residual value of the various treatments in making any estimate of their comparative costs and in calculating the economic results from their use.

The results given above show very clearly the value of combining green manuring with the use of superphosphate for Pusa farm soils; they also demonstrate the advantages to be obtained from the adoption of the method of fermentation and concentration of the green manure crop; data are not at present to hand which would enable the writer to make any computations of the cost of this method as compared either with the value of the increase obtained or with the cost of alternative methods of obtaining similar results.

It may be mentioned that notably increased yields have been obtained at Pusa by the application of fermented sann-hemp to such crops as tobacco and indigo. Fermented oilcake has also been found particularly efficacious as a quick acting nitrogenous manure for such valuable crops as tea and tobacco. In the case of tea this preparation is of particular value both for new clearances, infillings, and older bushes requiring stimulation before heavy pruning, comparing favourably with expensive imported manures both in efficacy and in cost. By proper precautions in fermentation and the use of suitable bacterial inoculations the content of nitrogen readily available for nitrification in fermented mustard cake may be brought up to as much as ten per cent., thus furnishing a quick acting nitrogenous manure at a comparatively low cost.

Incidentally the form of the experiment illustrates the value of the method of preliminary cropping, which enables the agriculturist to interpret the results obtained with some confidence in their reliability.

Owing to the falling off in fertility of these plots due to repeated double cropping without manurial treatment, it was decided to green manure the whole area. This was done in the monsoon of 1921, sann-hemp being sown and ploughed in on all the plots. The effect on the succeeding *rabi* oat crop (1921-22) was immediate and favourable, but the most interesting result was the extraordinarily marked increase on those plots which had received applications of superphosphate at the beginning of the experiment in 1917. Table VII shows the returns from these plots compared with the parallel set without super.

TABLE VII.

Effect of green manuring on rabi crop (oats) 1921-22 ; showing residual effect of superphosphate applied in 1917.

Plot No.	Original treatment in 1917	RABI OATS		Increase	Per cent.
		1920-21	1921-22		
21	Fermented sann, 3 to 1 concentration	511	909	498	97.450
22	Fermented sann, 3 to 1 concentration + super	577	1,768	1,191	206.40
25	Sann ploughed green	460	875	415	90.20
32	Sann + super	633	1,905	1,242	187.30
29	Fermented sann, 6 to 1 concentration	567	1,059	412	72.60
30	Fermented sann, 6 to 1 concentration + super	910	2,599	1,689	185.60

Average increase due to green manuring with sann-hemp alone .. 86 per cent.

Average increase due to green manure + superphosphate .. 192 per cent.

It will be seen that the average increase due to the green manuring of 1921 alone is about 86 per cent., whereas that apparently due to the residual effect of superphosphate combined with this green manuring is 192 per cent.

It may be stated that the oat crop on the super plots during growth showed unmistakable signs of the specific effect of the super especially in its early maturity, this being more marked in the plot which originally received the heavy application of fermented sann-

hemp. Apart from the interesting and economically important conclusion that in this soil applications of superphosphate do not lose their efficacy in the first season, but in the presence of adequate supplies of organic matter have a very considerable residual effect, we are faced with the extraordinary persistence of this residual effect over so many years. Harrison has demonstrated (*Mem. Dept. Agri. in India, Chem. Ser.*, Vol. V, No. 9, 1921) the rapid and complete removal of the water soluble portion of the phosphoric acid of the super from its solution in the soil water in Pusa soil as a result of chemical reaction with the calcium carbonate present in the latter. In view of the persistence of the "super effect" shown by the above experimental results we are obliged to conclude either that the P_2O_5 added to the soil as superphosphate remains therein in a condition different from that of the stock of soil phosphate originally present, or that the addition of superphosphate induces a condition in the soil favourable to the fertilizing action of added organic matter. The most noticeable feature of the increased yields obtained as a result of the fresh application of green manure was the specific character of the growth of the crop on the originally supered plots which showed those features universally associated with phosphatic manuring, especially early maturity. Now unless we are prepared to adopt the theory of Whitney and Cameron that the soil solution normally contains sufficient plant nutrients of all kinds, including P_2O_5 , to satisfy the needs of the crop, and that the fertilizing effect of applications of manures such as superphosphate is due to their indirect and secondary action on the soil, we are forced to the conclusion that in the particular case under consideration the renewed fertility on the supered plots was due to the residual fertilizing action of P_2O_5 originally added to the soil in the form of superphosphate. Hall in combating the theory of Whitney and Cameron has shown that the yield of crops increases in proportion to the amount of P_2O_5 present in the soil solution and that the latter does not ordinarily contain sufficient for a full crop. Moreover the suggestion that the fertilizing action of superphosphate may be due to other factors than its content of P_2O_5 , such as its acid character or its content of sulphur, seems to be negatived in this case

by the specific character of the growth already referred to. One of the features of phosphatic manuring is its specific relation with various crops and this is found whether the phosphate is supplied in the form of superphosphate or of alternative sources such as basic slag. The conclusion seems inevitable that in the case under consideration the relatively great revival of fertility resulting from green manuring on those plots to which superphosphate was originally applied must have been due to the residual action of the phosphate thus added to the soil. It remains open to suggestion that the fertilizing action of P_2O_5 is not due, or not entirely due, to its action as a necessary constituent of plant food, but that its presence in the soil solution is necessary either for the liberation or activation of some accessory plant food or soil vitamin of which we have no knowledge, or for the stimulation of those bacterial processes which we know to be necessary for soil fertility. It is certainly true that bacterial action in soils is stimulated by the presence of P_2O_5 in solution, and it is probable that in every soil active competition takes place between the micro-flora and the growing crop for the small quantities of this constituent generally present in the soil solution. Phosphatic manuring will therefore tend to increase fertility by supplying sufficient P_2O_5 to satisfy the needs both of bacteria and crop, but this conclusion does not eliminate the necessity of realizing that the plant benefits directly from such manuring by assimilation of phosphoric acid and that the characteristic "super effect" must be due, in part at least, to such assimilation.

How then does the addition of organic matter in the form of green manure bring into action the supply of phosphate which, as shown by the progressive decline in fertility of these plots, has been lying dormant or at least relatively unavailable, during the intervening period? The obvious suggestion arises that the addition of organic matter and not merely the agricultural operations incidental to its growth and burial is probably responsible for this result and the more so in consideration of the increased fertility shown to result from the combination of green manuring and phosphatic manuring. Now one of the principal effects of the addition of

organic matter to these soils is the very great increase in bacterial growth and activity and the suggestion at once arises that the renewal of the available phosphate supply shown on these plots is connected with the increased bacterial action resulting from the green manuring. There has been much conflict of opinion amongst soil bacteriologists as to the solubilizing action of soil bacteria upon insoluble phosphates, but there can be no doubt that under certain conditions such action takes place. Work in this laboratory on this subject during the past three years has demonstrated conclusively the possibility of considerable and continuous solubilization of tricalcic phosphate, such as apatite, purely by bacterial action under controlled conditions in the presence of sufficient organic matter. It has also been shown that greatly increased action of this kind takes place in the presence of added sulphur through the agency of specific sulphur oxidizing soil bacteria which have been found in Pusa soils. It is probable therefore that the increased bacterial activity resulting from the presence of added organic matter tends to keep in an available form some fraction of the added phosphate which would otherwise remain in the insoluble condition to which it naturally reverts in these soils, and it is further possible that the sulphur content of the super contributes to this effect through the intervention of *Thio bacillus thio-oxidans* and similar sulphur oxidizing bacteria. The rapid oxidation and consequent removal of the originally present organic matter characteristic of these soils would explain the falling off in fertility of the plots and the renewal of the super effect on the addition of fresh quantities by green manuring would follow as a result of the increased bacterial activity consequent thereon.

In the opinion of the writer bacterial action in the soil has a further action of equal, if not of greater, importance than the one referred to above. The superphosphate is applied to the soil at the time of sowing and although no doubt some portion of the manure remains in the soluble condition long enough to afford stimulation of growth to the seedling plant, a large proportion of its content of P_2O_5 would ordinarily pass into the insoluble tricalcic form before the growing crop could make use of it. Of this portion some part will

be taken up and utilized by soil bacteria and where sufficient supplies of organic matter are present in the soil this fraction, by reason of the rapid multiplication of bacteria consequent on the presence of adequate supplies of nutrient, may be a considerable one. This portion of the added phosphate will then be present in the soil in organic combination and will escape the fate of the remainder which reverts in the ordinary course to the tricalcic form. When by reason of the gradual exhaustion of the food supply the bacterial numbers diminish, this organic phosphorus will remain inert until such time as multiplication of the micro-flora of the soil due to more favourable conditions, brings it into circulation once more as food for the latter. Such favourable conditions would arise on the addition of fresh organic matter as green manure, and it is a matter for consideration and investigation whether this organic phosphorus thus brought into circulation once more can come within direct range of the higher plant's absorptive action or whether such fertilizing action as it appears to exhibit is an indirect one due to its provision of phosphoric food for those soil bacteria upon whose activities fertility depends. Comber has recently (*Jour. Agri. Sci.*, Vol. XII, Pt. 4) called attention to the important part played by the colloidal condition of soil constituents in plant nutrition and although it is impossible in this paper to discuss his suggestions as they apply to the question of the availability of the organic phosphorus formed by bacterial metabolism, yet there can be no doubt that there is very good reason to suppose that bacterial activity and intervention may very well transfer some considerable proportion of the P_2O_5 content of phosphatic manures such as superphosphate when added to the soil from the category of insoluble mineral phosphate to that of relatively available organic compounds.

There is of course the further possibility of reaction between the soluble phosphate present (either coming directly from the manure or from bacterial action on that already reverted) and the organic matter of the soil resulting in the formation of organic phosphorus compounds, this reaction being no doubt largely dependent upon bacterial decomposition of the green manure, the character of the product being also determined so far as its colloidal condition

and consequent availability is concerned by the nature of the bacterial action involved.

Given the facts observed, that the fertilizing action of superphosphate on these soils is dependent on the presence of adequate supplies of organic matter, and that the addition of organic matter increases bacterial action, the logical conclusion follows that there is probably some connection between bacterial action and the fertilizing effect of superphosphate in these soils. This conclusion is further supported by observation that bacterial action is capable of solubilizing tricalcic phosphates and that this action depends upon the presence of organic matter.

The general conclusion appears to be that the efficacy of superphosphate as a manure in these soils depends largely upon bacterial intervention, and that the astonishing persistence of the "super effect" on these plots is, to some extent at any rate, due to the formation by bacterial action of relatively available organic phosphorus compounds. For the agriculturist, the practical conclusion is that a high economic return from the use of superphosphate will depend upon an adequate supply of organic matter and the existence of soil conditions such as to secure its active bacterial decomposition.

UNAVOIDABLE ERROR OF FIELD EXPERIMENTS.

BY

O. T. FAULKNER, B.A. (Cantab.),

Director of Agriculture, Nigeria.

INTRODUCTION.

A CONSIDERABLE number of studies of the unavoidable error of field experiments have been made during recent years. Of these studies the work of Messrs. Wood and Stratton (*Jour. Agri. Sci.*, III, 4, 1910) and Mercer and Hall (*Jour. Agri. Sci.*, IV, 2, 1911) were the first and may be taken as typical. The object of these experiments is to study the error of comparing a number of plots taken "at random" and differently treated; and to study how this error is affected by the use of various numbers of plots and various sizes and shapes of plots. The method is to divide a uniformly cropped field into a large number of unit plots. The yields of these units are then added together to give the yields of composite plots of the various shapes, etc., required. The differences between the yields of the composite plots and their average yield are then considered to be the unavoidable errors which would have occurred if the various plots had been differently "treated," and the differences from the average of a number of "control" plots regarded as being the effects of the treatments.

The conclusions arrived at by the authors referred to above have, in the main, been confirmed by subsequent studies carried out in the United States on similar lines. But it is to be noted that almost all the studies referred to deal with the comparison of plots selected in a random manner, the yield of any "treated" plot being compared with the yield of one control plot, or with the average yield of all the control plots. If a very large number of different treatments (*e.g.*, many different methods of manuring or

many different varieties of a crop) have to be compared, this method is probably the best, and certainly the easiest possible. But it has been realized in many parts of the world (as is shown by numerous published accounts of experiments) that more accurate results are obtained when only two kinds of treatment or only two varieties are compared, and the yields of only adjacent plots are compared. But although "Student" in an appendix to Mercer and Hall's paper practically drew attention to this point, yet there has been no quantitative comparison of the accuracy of this method and the random method, nor any quantitative study of the effect of variation in size and shape of plot, when the yields of adjacent plots only are compared. The present paper attempts to fill this deficiency.

THE CRITERION ADOPTED.

In such studies as those referred to in paragraph 1, the standard error, which is used for deductions as to the probability of the apparent observed result being vitiated by unavoidable error, is either (a) the standard (Root—Mean—Square) deviation of the yields from the average yield, or (b) the probable error which is simply the standard deviation multiplied by 0.67. The adoption of these figures as a measure of the unavoidable error is based on the assumption that the average yield represents the "truth"; and that any deviations in the yields of plots which have all been similarly treated, from their average yield, represent unavoidable errors. On similar lines it is evident that if each difference in yield between two similarly treated adjacent duplicate plots represents an unavoidable error, then the correct statistical measure of a series of such errors is the Root—Mean—Square difference between adjacent plots, for which the symbol R^* is used in this paper.

Wood and Stratton, in that part of their paper in which they deal with the differences between a series of pairs of duplicate plots, considered the error of each plot to be half the difference between

* Thus if the differences between the yields per acre of the various pairs of duplicate plots in a series of n pairs of duplicate plots be d_1, d_2, \dots, d_n then

$$R = \sqrt{\frac{d_1^2 + d_2^2 + \dots + d_n^2}{n}} = \sqrt{\frac{\Sigma d^2}{n}}$$

each pair of plots, and therefore used the Root—Mean—Square—half—difference $\left(\sqrt{\frac{\sum d^2}{4n}}\right)$ as the standard error of each plot in the series of duplicates. This appears to be incorrect. For in deducing a figure for the standard error of plots, from the differences between the yields of pairs of plots as Wood and Stratton do, they are neglecting any possible correlation between the duplicates; and they regard each plot as a member of a series of plots, the yields of which differ, when pairs are taken at random, to the same degree as do these pairs of duplicates. Therefore the standard deviation of this imaginary series, which is what they wished to calculate, is $\sqrt{\frac{R}{2}}$, *i.e.*, $\sqrt{\frac{\sum d^2}{2n}}$. Thus the estimates of standard error in that part of their paper appear to be too low in the ratio 1 : $\sqrt{2}$.

Further, in the calculation of the results below, another departure from the usual method has been made. In comparing the standard errors in the yields of plots of different sizes it is necessary to reduce the calculated standard errors to a common basis. There are obviously two methods by which this can be done, either by expressing the yield of each plot as yield per acre, and regarding the differences in the yield per acre as representing the errors, or by expressing the errors as a percentage of the average yield of the plots. Now the latter method is obviously more complicated than the former and is liable to lead to unwarranted assumptions. Thus it appears to involve an assumption that the differences in yield per acre between similarly treated plots will be greater in a good year or on good land than in a bad year or on poor land. This has not been the present author's experience. Further, this method involves an assumption that the standard deviation of similarly treated similar plots, when expressed as a percentage of the average yield (*i.e.*, the co-efficient of variation), will be much the same with different crops. Wood and Stratton's figures appear to give some evidence in favour of this view. But on examination it will be seen that the evidence is only an indication of an extremely rough generalization, especially when those figures which need it are corrected according to paragraph 4 above. In the absence,

DIAGRAM 1.

Showing the individual tree yield (in pounds) of the navel-orange grove (Arlington).

Each tree occupies 22' x 22'.

82	77	39	114	85	60	45	94	82	71	102	108	70	108	127	64	166	156	170	83
74	105	118	124	81	110	131	141	122	104	117	108	116	150	131	225	199	119	180	171
66	69	74	79	211	84	137	23	15	107	127	163	125	140	180	168	161	203	322	277
75	55	84	98	132	108	147	152	101	106	83	179	105	143	148	158	106	166	255	61
84	71	82	109	99	127	156	110	175	159	173	196	159	39	99	152	142	268	218	142
48	81	57	87	69	90	136	164	112	96	46	104	136	213	197	195	191	197	184	80
70	81	79	109	150	90	112	121	118	158	151	116	166	131	148	182	164	182	186	156
54	105	82	128	101	81	135	143	198	157	211	127	140	141	115	169	180	190	238	112
72	82	57	86	111	75	56	153	140	107	143	180	145	161	79	75	147	156	223	172
28	49	48	71	84	89	33	60	165	138	126	145	149	139	107	127	152	172	32	75
61	31	50	65	95	75	112	112	101	120	120	131	137	217	191	123	180	124	117	171
68	60	100	79	98	115	110	135	74	142	90	109	175	192	182	123	173	155	35	127
33	80	67	69	118	64	103	190	109	210	51	78	163	116	130	101	122	121	154	69
36	91	101	90	80	95	78	148	107	162	161	76	123	132	114	126	152	121	167	152
76	109	93	89	107	49	84	164	97	124	135	147	101	103	175	90	225	167	50	146
49	99	81	131	109	74	123	146	156	203	146	157	156	137	180	178	140	149	159	92
92	123	75	45	77	61	135	93	95	224	122	178	166	170	240	208	141	168	162	90
34	98	89	73	123	69	139	187	164	150	163	84	111	152	176	150	150	107	130	129
45	57	68	37	71	83	109	45	94	139	128	141	68	79	137	90	80	130	143	107
53	90	128	99	72	73	80	117	137	160	152	131	116	113	169	90	57	97	110	102
91	80	101	117	79	135	135	62	186	132	99	80	135	124	215	105	63	85	126	69
73	117	83	97	47	126	116	111	115	135	105	86	103	166	164	119	115	103	152	123
76	83	81	84	119	67	126	76	116	111	93	44	118	165	162	34	107	81	78	28
148	131	86	87	98	89	107	123	108	89	57	122	102	182	125	75	65	147	86	102
59	66	85	71	90	58	114	90	45	116	63	99	70	117	169	22	80	71	59	59
86	64	78	131	174	135	111	90	93	135	112	90	152	123	143	100	33	130	114	63
28	76	90	144	135	111	135	116	57	190	122	122	79	165	153	164	167	195	113	89
51	73	79	164	161	115	127	101	71	189	180	208	140	107	154	133	107	130	103	84
54	82	135	141	135	90	135	160	46	120	138	90	127	82	135	63	68	91	25	5
162	135	155	114	163	180	209	95	163	146	164	80	110	74	54	92	90	57	103	70
118	147	135	120	50	95	151	61	98	148	135	189	118	130	76	82	174	88	91	107
103	106	62	102	135	123	135	185	148	161	180	241	151	183	95	122	138	165	137	121
111	69	106	158	90	104	180	145	135	117	164	180	135	161	180	135	142	160	180	90
135	124	135	142	140	140	239	225	193	142	156	180	218	165	213	213	180	157	152	97
115	100	119	164	135	169	180	176	135	112	90	159	167	90	192	139	135	135	154	69
127	135	116	143	125	150	214	196	169	100	180	180	164	165	225	157	195	150	251	165
180	104	135	148	161	135	142	164	90	154	191	135	149	116	183	173	159	210	238	107
118	135	135	154	141	180	160	211	161	147	198	214	200	144	215	159	77	147	214	180
123	159	154	181	180	150	240	223	151	128	185	194	186	200	212	180	156	168	225	164
184	183	239	169	159	146	211	180	178	202	223	147	162	177	145	237	192	148	204	55
100	168	116	225	150	179	196	214	193	218	214	187	112	117	131	101	131	127	110	85
202	166	132	241	210	262	201	190	144	136	155	203	162	196	121	102	167	181	120	225
190	168	194	239	185	176	215	249	153	163	180	175	225	140	108	191	156	155	255	180
108	163	225	192	225	150	180	254	147	152	146	147	155	95	122	163	154	187	166	139
205	201	108	188	211	249	270	238	162	198	214	228	158	87	172	224	154	258	209	168
136	137	182	153	229	221	261	219	129	151	132	144	201	178	152	188	218	148	171	149
186	205	190	177	252	197	238	341	173	138	257	231	206	248	180	248	207	254	225	167
195	181	200	208	212	141	288	85	122	149	324	251	212	230	151	215	92	225	225	192
158	227	139	114	251	206	267	280	214	325	175	250	226	220	149	180	154	135	202	117
142	192	140	208	210	183	243	264	161	176	226	280	275	222	180	268	194	144	203	166

therefore, of any strong reasons for adopting the percentage method, it appears preferable to use the method of yields per acre which is simpler and leads to fewer assumptions. The latter method is adopted in this paper. The statistical measure of errors which has been used is, therefore, the Root—Mean—Square—difference between yields per acre of pairs of adjacent plots.

THE MATERIAL USED.

Two sets of data have been used : (1) the yields from a thousand orange trees given by Batchelor and Reed (*Jour. Agri. Res.*, XII, 5, 1918, p. 245), and (2) the yields of plots of wheat given by Montgomery (*U. S. Dept. Agri. Bur. Pl. Ind. Bull.* No. 269). The two sets of figures are given in Diagrams 1 and 2.

DIAGRAM 2.

Showing the observed yield (in grammes) of grain on each of Montgomery's wheat plots in 1908-9. Each plot is 5.5' x 5.5'.

723	741	838	770	719	756	682	588	620	617	653	636
795	716	742	690	851	703	700	679	729	646	511	478
677	763	755	851	768	723	752	650	568	623	395	410
680	795	936	664	745	732	703	629	609	611	580	568
680	843	793	725	777	680	764	791	576	621	583	530
753	666	995	787	768	863	745	806	765	665	723	713
710	768	764	860	661	740	624	648	793	742	685	690
732	786	759	774	652	752	620	606	673	604	775	730
739	768	770	724	698	572	600	574	655	728	777	600
592	660	640	680	772	650	657	632	726	721	691	563
686	645	613	709	742	643	639	644	722	779	664	655
760	667	543	760	765	704	662	692	706	776	668	650
755	632	715	673	675	642	685	645	720	777	835	709
703	613	623	654	620	705	615	560	722	596	726	640
657	713	671	680	580	598	633	373	425	526	683	662
671	658	657	642	735	575	727	572	580	588	617	602

METHOD OF CALCULATION.

The comparison of the standard errors in using different shapes and sizes of plot is carried out in one operation by means of the following device. Broad plots are made up of a number of adjoining units. The difference in yield per acre between each plot and a plot similar to it and adjoining by the short side is then calculated, and similarly the Root—Mean—Square—difference between all such pairs of plots. Similarly long plots are dealt with consisting of composite plots adjoining by their long side. Diagram 3,

DIAGRAM 3.

Showing (by diagonal lines) the method of joining the unit plots to form composite plots.

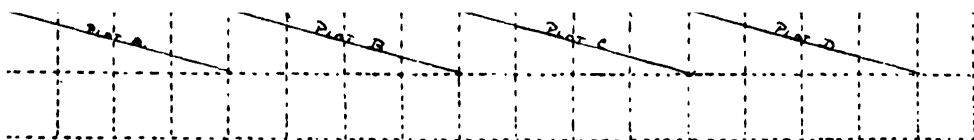

Broad composite plots.

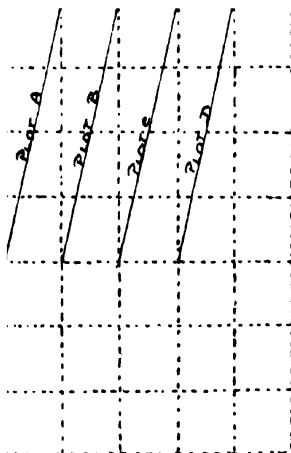

Long composite plots.

showing pairs of broad and long plots made up from four units, will explain the method more clearly than can be done in words. The differences calculated in each case are between the yields per acre of the composite plots A and B, C and D, respectively. Further a

calculation has been made of the standard error of comparing pairs of composite plots made up of scattered units. This standard error is evidently $\sigma \sqrt{\frac{2}{n}}$, where σ represents the standard deviation of the yields per acre of the original unit plots, and n represents the number of scattered unit plots in each composite plot, just as the probable error of such a comparison would be $0.67 \sigma \sqrt{\frac{2}{n}}$ (see Wood and Stratton's paper quoted above).

THE RESULTS.

The results of the calculations are given numerically in Tables I and II and graphically in Figs. 1 and 2.

TABLE I.

Standard errors in comparing plots of different shapes and sizes.

Number of units in plots	BROAD PLOTS		LONG PLOTS		Plots made up of scattered units $= \sigma \sqrt{\frac{2}{n}}$
	Mean difference	R.M.S. difference R	Mean difference	R.M.S. difference R	
1 ..	207.0	4614	207	4620	6925
2 ..	351.9	3479	207	3580	4898
4	207	2804	3463
5 ..	772.6	2928	207	2596	3091
10 ..	1398.2	3372	207	2114	2191
20	207	1676	1549
25 ..	379.2	4510	1385

(Original data from Batchelor and Reed, *Jour. Agri. Res.*, XII, 5, p. 245, 1918.)

The yields are given for 1,000 unit plots, each 22 feet square and containing one orange tree. The errors above are calculated from the yields per acre of composite plots made up by combining these unit plots. Mean yield per acre of original plots is 12,420 lb., standard deviation of yields per acre is 4,898 lb.

TABLE II.

Standard errors in comparing plots of different shapes and sizes.

Number of units in plots	BROAD PLOTS		LONG PLOTS		Plots made up of scattered units $= \sigma \sqrt{\frac{2}{n}}$
	Mean difference	R.M.S. difference R	Mean difference	R.M.S. difference R	
1 ..	12.68	285.96	12.68	286.1	413.50
2 ..	35.80	253.10	12.68	223.4	286.20
4 ..	40.15	231.86	12.68	176.1	201.80
6	12.68	133.2	165.40
8 ..	127.20	259.75	143.10
12	12.68	110.5	11.66

(Original data from Montgomery, *U. S. Dept. Agri. Bur. Pl. Ind. Bull.* No. 269, quoted in *Jour. Agri. Res.*, V, 22, p. 1044, 1916.)

The original data give the yields of 224 unit plots of wheat 5.5 feet square in grammes. The yields of 192 of these plots are used in calculating the table above, the yields being expressed in pounds per acre. Mean yields of the 192 plots is 2,173 lb. per acre, and standard deviation of yields per acre is 296.2 lb.

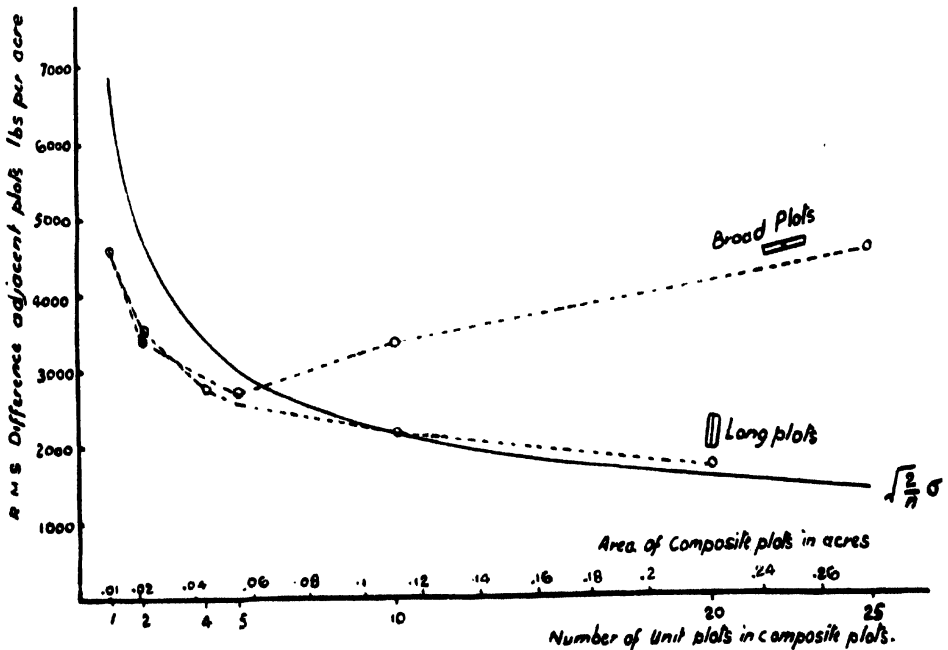

FIG. 1. Root-mean-square-differences between yields per acre in pounds of adjacent plots of Navel orange trees (Arlington grove) made up by combining the yields of unit plots, each 22 feet square and containing one tree. The "long plots" are thus 22 feet wide and of varying length, and the "broad plots" 22 feet long and of varying width. (Data from Batchelor and Reed, *Jour. Agri. Res.*, XII, 5, 1918.)

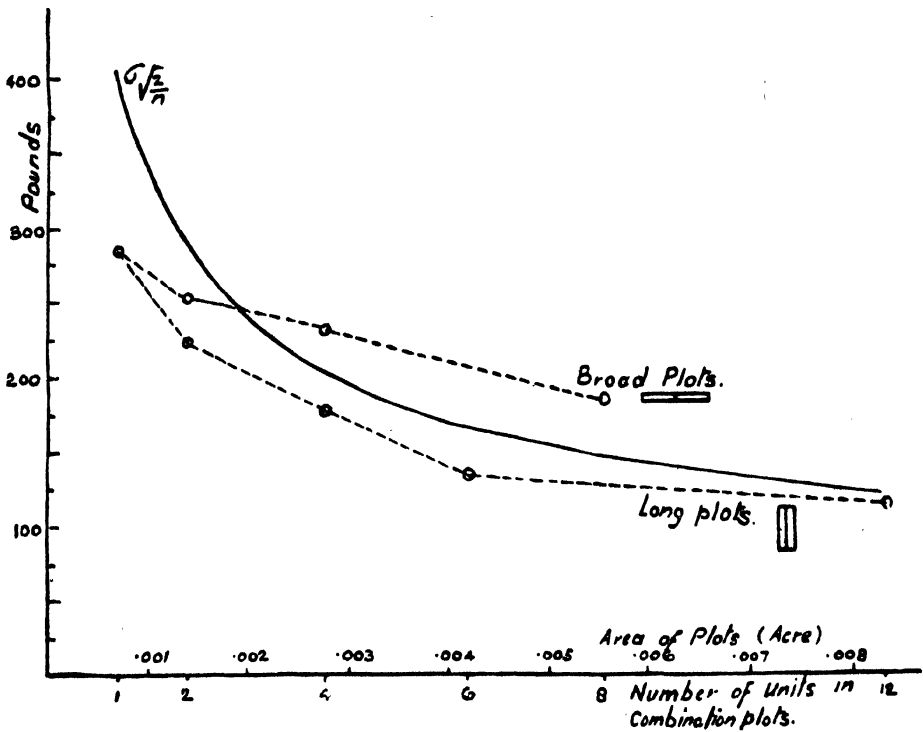

FIG. 2. Root-mean-square-differences between yields per acre in pounds of adjacent plots of wheat made up by combining the yields of unit plots each 5.5 feet square. The "long plots" are thus 5.5 feet wide and of varying length, and the "broad plots" 5.5 feet long and of varying width. (Data from Montgomery, *U. S. Bur. Pl. Ind. Bull.* 289.)

CONCLUSIONS.

(a) It is evident that there is in general a considerably smaller standard error in comparing adjacent plots than in comparing plots taken at random: the errors in these two methods in both of the two cases studied are roughly in the proportion of 2 : 3, when dealing with the original square unit plots. It is not easy to see why the advantage of comparing adjacent plots is much the same in both sets of data. If this is due to anything more than coincidence, it is possibly connected with the fact that both fields probably represent as uniform stretches of land as could readily be found. It is reasonable to suppose that in the case of less uniform land the advantage of comparing only adjacent plots would be greater. The error in comparing broad plots, which are more than 4 or 5

times as broad as they are long, is, however, greater than in comparing plots made up of a similar number of scattered units. This would, as a matter of fact, reasonably be expected, and is only of theoretical interest; for no experimenter would actually compare plots arranged in this way. The errors in comparisons of adjacent long plots, and in comparing composite plots made up of scattered units, are in both cases much the same, when the number of units in the composite plots is as many as 10. With plots containing fewer units, the long adjacent plots are better. It will be realized that in regard to many practical considerations, such as the carrying out of cultural operations, the simplicity of record, etc., adjacent long plots have very great advantages as compared to plots made up of scattered units.

(b) As regards increase of width, without simultaneous increase of length, the minimum error is obtained with a plot of the width of five units—110 feet in the case of the apples and $27\frac{1}{2}$ feet in the case of the wheat.

(c) An increase of length of plot without simultaneous increase of width throughout lessens the standard error of the comparison of the yields of adjacent plots. And an increase of length of plot is much more effective than a corresponding increase of width. A further increase in length beyond five units has, however, not a great further effect.

(d) In actually laying out plots so as to get from a given area of land results which shall be affected by unavoidable errors to the minimum possible extent, the following advice is based on the results obtained in this paper.

(i) Compare only adjacent plots.

(ii) The width of each plot should be the minimum consistent with other considerations, such as reducing the border effect to reasonable proportions. For instead of increasing the width of each plot beyond this minimum it would be better to have more duplicates.

(iii) The length should be five times the width.

ACKNOWLEDGMENT.

I have to thank the Agricultural Department of the Punjab for the opportunity of carrying out this work, and Mr. S. M. Jacob, I.C.S., late Director of that department, for valuable constructive criticism.

MILL TRIALS OF SELECTED COIMBATORE SUGARCANE SEEDLINGS.

BY

WYNNE SAYER, B.A.,
Secretary, Sugar Bureau.

It has been generally recognized that the problem of the improvement of the Indian sugar industry is primarily one of increasing the tonnage of sugarcane per acre, the establishment of new factories on modern lines and the improvement in their efficiency ranking next in importance to it. While Java produces over 40 tons, Hawaii 41* tons and Cuba 20 tons cane per acre, over the greater part of Northern India, where by far the largest portion of the total area under cane in India is grown, the average yield is hardly 300 maunds or 11 tons per acre. It will thus be seen that while a factory in Java working with 500 tons of cane per day can be supplied with its raw material for one day's working from 12 acres, a similar factory working in Northern India has to draw from no less than 45 acres entailing increased expenditure on cartage and laborious arrangements for the supply of cane and this results in keeping down the number of factories which can work profitably in a given cane area. The question that awaits immediate solution is thus primarily one of improvement in the yield of cane per acre so that the cultivator may derive increased profits and the factories may be enabled to get their raw material from a smaller area.

Now, it is well known that the cultivator in Northern India has usually not enough money to spend on manures and that his cultivation is indifferent. What is required, therefore, is a better yielding variety which can stand this indifferent treatment and at

* The yield of cane per acre for the whole of the Hawaiian Islands during the years 1921 and 1922 was 41 tons (1 ton=2,000 lb.), though in Maui and Oahu the average was as high as 50 and 48 tons respectively.

the same time give a higher tonnage per acre without much manure. In this connection it has been found that of the three recognized lines of improving the tonnage per acre by the (1) introduction of exotic varieties, (2) selection and improvement of indigenous canes and (3) raising new cross-bred canes, the one depending upon the importation of foreign canes is not likely to lead to permanent and substantial results. These exotic varieties, produced for totally different conditions and found successful there, are unsuited over large tracts in Northern India, where the cultivators are not in a position to give them the required careful cultivation, heavy manuring and irrigation. Further, these canes are liable to disease, and hence it is that in spite of repeated importations only a very few have made good as field crops and these too in tracts which are especially suited for thick canes, *e.g.*, Madras, Bombay, Bengal and Assam. The second line, *viz.*, the selection of indigenous varieties and their cultivation according to improved methods does not hold out any prospects of substantial results for the simple reason that the increased yields are not always commensurate with the extra expenditure involved, the extra tonnage failing to produce a proportionate amount of sugar owing to the limitations of the varieties themselves.

As in all other countries, the line of work that holds out the greatest prospects of success is that of raising seedlings by crossing the exotic varieties with the best local canes. The Sugarcane-breeding Station at Coimbatore has therefore concentrated its attention on evolving new seedlings on these lines. This station, though mainly intended for North Indian work, had to be located in South India because cane rarely flowers in North India, and even when it does, does not generally set fertile seed. It will thus be seen that the canes bred at Coimbatore require to be acclimatized and tested in North India before they can be distributed to cultivators. In this connection it is necessary to emphasize that a reliable and careful testing of the new seedling canes in the tracts for which they are ultimately intended is as important as the actual raising of these seedlings by the complicated and laborious process of cross pollination.

It was early recognized that exotic canes are not worth persevering with under the conditions existing in the white sugar tract in North Bihar. Attention was therefore concentrated at Pusa on the acclimatization and testing of Coimbatore seedlings. Work in this direction has now been in progress for over five years.

It was found after the first two years that three seedlings, *viz.*, Co 210, Co 213 and Co 214, were likely to prove suitable for Northern India and accordingly in January 1921 arrangements were made to multiply up these canes according to the Java method to provide sufficient seed to plant out a large area for mill trials in December 1922. This method of short planting for rapid multiplication of seed of a particular variety had hitherto not been attempted in this country, but in the present writer's opinion there was nothing in the local conditions to prevent it from succeeding and it was accordingly tried and proved an immediate success. This method enabled the three seedling canes to be put through the mill by the end of 1922, a saving of over three years as against the ordinary method.

The method adopted was as follows: The cane was planted in February and forced on under irrigation until the break of the monsoon in July when the entire cane was cut and replanted in high land. By the following February this cane was ready to cut for seed again and one acre originally planted in February gave sufficient seed to plant 36 acres in the following year.

The chemical analysis had already shown that Co 214 was an exceptionally early ripening cane and that it was followed by Co 210 and Co 213 which ripened in succession, thus forming an extremely valuable chain of early ripening canes all maturing before the end of December. The value of this can be understood when it is realized that hitherto it had been practically impossible for any factory in Bihar to start crushing before the second week in December as the local cane being a late ripener was not fit to work before that date at the earliest. It was clear, therefore, that if these canes proved a success at the mill, they would lengthen the working season of the factories considerably and enable the latter to increase their output of sugar. The field tests showed that all these canes

were an improvement on the local cane on a tonnage basis, the improvement being most marked in the case of Co 210 and Co 213, the latter being an exceptionally hardy, vigorous and heavy tonnage cane. With a view to test these canes thoroughly under factory conditions, an area of 22 acres was planted out in February 1922 in the proportion of 10.99 acres under Co 214, 6.01 acres under Co 213 and 5 acres under Co 210. The land chosen was part of an area recently taken over from ryots and was not considered by local growers to be good land for cane nor in any way exceptional, and it was felt that under such conditions a thoroughly fair trial under estate conditions of the tonnage capacities of these three canes might be expected. Arrangements were made to have the cane taken by the mill at the earliest possible date—beginning with Co 214 and followed by Co 210 and Co 213 in the order named so as to ascertain their behaviour under mill conditions and the sugar actually yielded by them as compared with the best local variety.

It is necessary here to emphasize that such mill trials are essential for ascertaining the actual value of a cane to the factory. As the analysis made in a laboratory where the juice is expressed by a two or three roller mill gives much higher results than those obtainable in a factory where many other factors have to be taken into consideration, to base all calculations on the laboratory results alone does not meet the case. The value of a cane is its value to the grower and to the mill when grown and crushed in bulk, and figures obtained from large scale tests are the figures which really carry weight among the growers and the mills. The laboratory and experimental plot tests are excellent guides but do not represent final judgment in such cases.

A brief description of the *method of cane growing* followed at Pusa would not be without some interest to the reader. The land to be put down under cane in February was kept fallow from previous October and given a thorough preliminary cultivation. Early in February the furrows were opened out with a double mould-board plough, followed by a subsoiler working in the furrow to stir up and loosen the subsoil. Oil-cake at the rate of half a ton per acre was then applied and the sets placed in the furrow, end to end, and

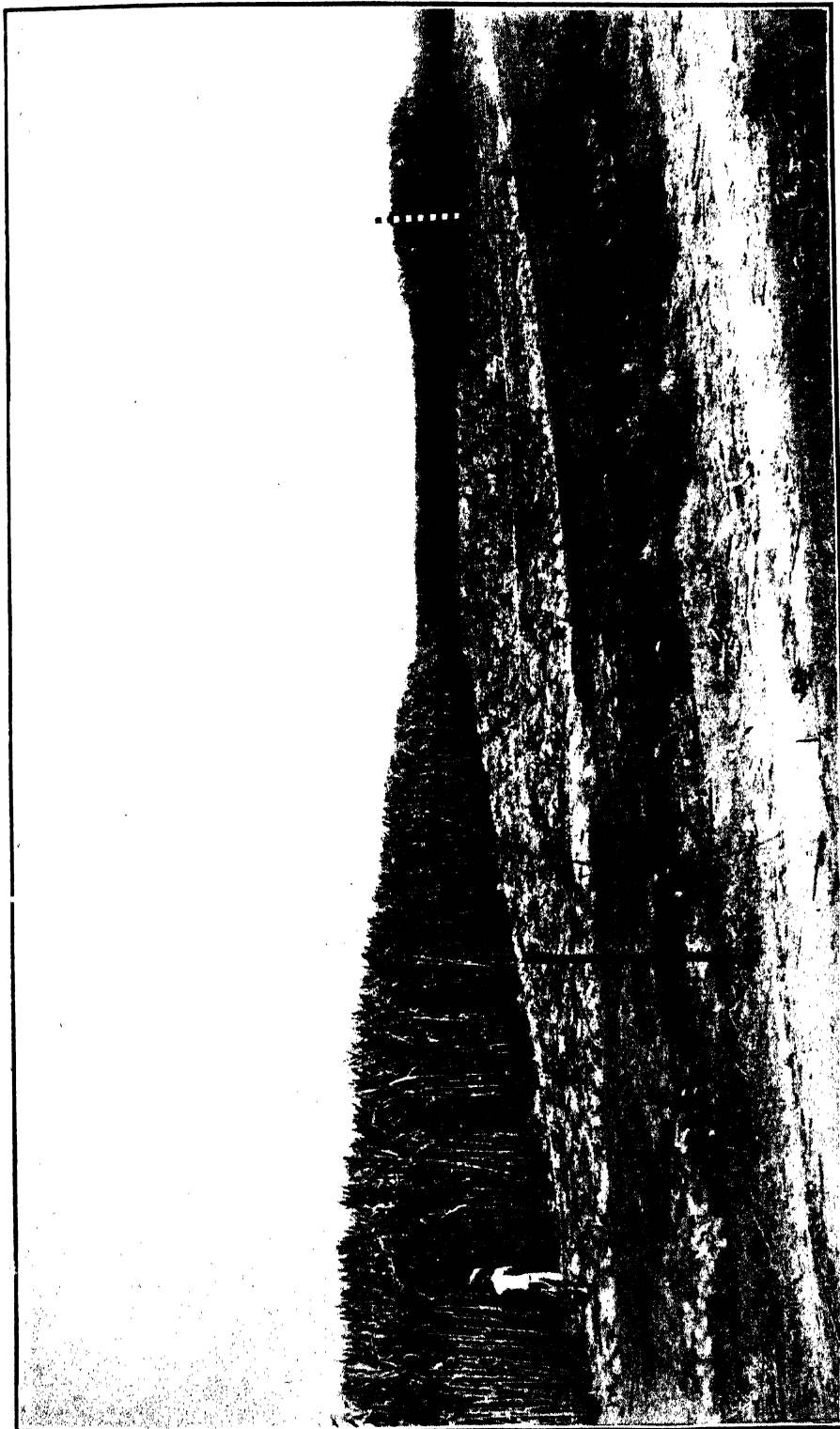

A general view of Co 213 sugarcane grown on a large scale without irrigation at Pusa.

covered in with a gatherer. The distance between the rows was kept at three feet. The only after-cultivation given was one hoeing every month in the hot weather and ridging up at the break of the rains. It is necessary here to mention that sugarcane is grown throughout the white sugar area in North Bihar without irrigation and has to stand several months of intense heat before the monsoon breaks. These Coimbatore seedlings were also grown without irrigation. These canes are reputed to be good drought-resisters and their behaviour during the growing season was excellent. The hot weather of 1922 was a most trying one and a temperature of 110°F. was experienced on several days with hot winds. During this hot weather Co 213 never showed any drying of leaves. Co 214 and Co 210 also stood it remarkably well. After the rains these canes made rapid progress and early in July their superiority over the local canes began to assert itself. While there was a slight shoot borer attack in Co 214 and Co 210, the variety Co 213 was free from any fungus or insect pest. These canes have a hard outer rind and so are not damaged by jackals. The average yield of stripped cane per acre amounted to 600 maunds of Co 214, 700 maunds of Co 210 and 800 maunds of Co 213. The cost of cultivation including preparatory tillage, rent, manuring, price of sets, planting and after-cultivation averaged Rs. 125 per acre. The crop was seen by the majority of the large sugarcane growers of Bihar and their opinion of it is best shown in the fact that applications for seed would have required twenty times the available area to meet them.

It has been mentioned above that one of the objects in growing these canes on a large scale was to ascertain their value from a factory point of view. Accordingly, arrangements were made with Messrs. Begg Sutherland & Co. to conduct the mill tests at one of their factories situated at Ryam near Darbhanga. The writer desires to take this opportunity of expressing his obligations to this firm for the great assistance they have given him not only in connection with these mill tests but also in financing sugarcane experiments on a large scale. Without their financial assistance this work would not have been carried out, and their ready appreciation of the value

of the work is the best testimony to its general importance to the industry as a whole.

The first mill trial took place on the 6th December, 1922, when 2,444 maunds of Co 214 were supplied to the factory for crushing. This cane is ripe by the beginning of November when the local cane Hemja is still unfit for the mill. An early cane is a great desideratum with the factories in North India and as Co 214 will enable them to extend their working season, the value of this cane is to be judged mainly from that point of view. Its yield is certainly double that of the best local cane Hemja, but as one of the parents of this cross-bred cane is Saretha, it has inherited a recumbent habit and is liable to be blown down by high winds. Another undesirable character in this cane is its high fibre content (18 per cent.) which is the result of having *S. spontaneum* as one of the parents. In spite of these two defects Co 214 is a good cane not only for the cultivator but also for the factory as the following results of the mill trial will show :—

Comparative analysis of the first mill juice.

	Co 214 crushed on 6th December	Hemja (Local variety) crushed on 7th December
Brix	19.30	16.70
Sucrose	15.94	13.54
Purity	82.58	81.08

It must, however, be remembered that Co 214 was being crushed at a much later date than originally intended and a comparison between it and Hemja taken in the second week of November would have given even more satisfactory results.

The second mill trial took place on the 18th December when over 2,000 maunds of Co 210 were put through the mill. This cane has a better tonnage than Co 214 and its fibre content is lower

(15.66 per cent.), but it is a month later in ripening. The following table shows the results of analysis of the first mill juice :—

			Co 210
Brix	18.23
Sucrose	14.95
Purity	82.00

The last mill trial took place with Co 213 on 27th December, 1922, when 2,500 maunds cane were supplied to the Ryam factory. Of the three canes this is clearly the best cane from the grower's point of view. It is a straight cane, does not lodge easily, has an even growth, is practically immune from fungus and insect pests and yields on an average 800 maunds of stripped cane per acre. Its fibre content is 16.84 per cent., *i.e.*, lower than that of Co 214. The results of the factory analysis of the first mill juice were as under :—

			Co 213
Brix	17.63
Sucrose	14.52
Purity	82.86

It is clear that the Co 214, *apart from the increased tonnage which it gives compared with the local cane*, actually yielded about 15 per cent. more sugar in the factory and as this variety can be crushed at a time when no local cane is worth milling, the sugar extracted from it is all *clear gain* over that which could be extracted from any local variety at the time. With Co 214 a factory can begin its campaign early in November, in December it can carry on with Co 210 and Co 213. Thereafter the local cane Hemja which usually ripens in January becomes available for crushing and thus the factories will be able to work under optimum conditions. As soon as the results of the mill trials became known, there arose a very heavy demand for these canes. From the cane left over from the present crop a distribution was therefore made to important cane growers in all the districts of North Bihar to avoid the loss of a year and full instructions were supplied to enable these growers to multiply the seed cane by the short planting method. Arrangements have also been made for a further distribution of these

canes from some 60 acres in February 1924 to the members of the Cane Growers' Association in Bihar who have provided the necessary finance for the purpose.

These varieties have also been supplied in small quantities to the Cossipore Sugar Factory and are reported to be making good progress. Co 213 has been despatched for trial as far east as Dacca and as far west as Peshawar.

If the results so far obtained at Pusa are realized on the cultivators' fields as it is believed they will, having regard to the fact that these are hardy canes which can stand even indifferent cultivation, a distinct step forward will have been taken in improving the material condition of sugarcane growers in North India, in increasing the output of sugar factories located in this tract and in finding room for the establishment of more factories, while subsequent years should find us in a position to deal with tracts requiring a special cane to meet special conditions. As it is generally recognized that these seedling canes deteriorate after some time, the replacement of the varieties already given out is engaging attention, and at the date of writing the author has got another early cane planted under estate conditions for a mill trial and no fewer than 40 new seedlings are being grown for testing and multiplication.

The author desires to express his thanks to the Imperial Agriculturist and his staff for the continued assistance and facilities afforded to him, also to the Imperial Agricultural Chemist and his staff for the analysis of various sugarcane samples sent to them from time to time, and finally to Dr. Barber and Rao Saheb T. S. Venkatraman, the Government Sugarcane Experts at Coimbatore, whose original work was the foundation of all that is now being done by the Sugar Bureau.

FIFTH ENTOMOLOGICAL MEETING, PUSA, FEBRUARY 1923.



Fifth Row—(Standing) Messrs. Makerjee, Ojha, Bashir, Torabaz Khan, D. P. Singh,
 Messrs. Iyengar, R. N. Singh, Sultan Ahmad, G. D. Misra, Sharma, Mujtaba, Shaffi,
 Third Row—(Standing) Rao Sahib Rama Chandra Rao, Messrs. Naoorji, G. R. Dutt, Rai Bahadur C. S. Misra,
 Messrs. Bennett, Isaac, Timony, Harchand Singh, Sen.
 Second Row—(Seated) Mr. Husain, Major Hingston, Dr. Beeson, Messrs. Bainbrigge Fletcher, Richards, Edwards,
 Major Sinton.
 First Row—(Seated) Rai Sahib P. N. Das, Messrs. Bose, Ram Saran, Pillai, Menon, Phadke.

THE FIFTH ENTOMOLOGICAL MEETING.

THE Fifth Entomological Meeting, in continuation of the biennial Meetings commenced in 1915, was held at Pusa from 5th to 10th February, 1923, and was attended by over forty persons interested in the study of Indian Insects, the visitors including delegates from the Forest Research Institute at Dehra Dun, the Central Research Institute at Kasauli, Muktesar, Madras, the Punjab, the United Provinces, Bihar, Mysore, Kashmir, Gwalior and Ceylon, besides amateurs and others. As on previous occasions, the procedure followed took the form of the reading, either in full or in abstract, of papers previously prepared, and the discussion by the Meeting of any point arising in connection with the various subjects dealt with in the papers, of which some seventy were included in the programme.

The proceedings were opened by Mr. S. Milligan, Agricultural Adviser to the Government of India, in a brief speech of welcome to the visitors, and this was followed by an address by Mr. T. Bainbrigg Fletcher, Imperial Entomologist, in which he also welcomed the visitors and dealt briefly with recent progress in Indian Entomology. After referring to the losses by death since the last Meeting of two members of the Pusa Entomological Staff and of eight other workers on this subject, he pointed out the comparatively brief period in which so much information has been acquired, and the directions in which future progress may be expected. In connection with the subject of publications, he referred to the bibliography which is now, by order of the Board of Scientific Advice, issued as a separate publication, and again drew attention to the extremely scattered manner in which papers dealing with Indian Insects are still appearing.

Turning to the programme before the Meeting and referring especially to a paper on a new Cotton Bollworm in South India, in which case taxonomic examination has shown that the insect in

question is indigenous in South India and Ceylon and not, as was at first supposed, a case of importation of the South African Red Cotton Bollworm (*Diparopsis castanea*), Mr. Fletcher remarked that he had "for years urged the view that real success in economic work can only be secured if built up on a firm foundation of knowledge of the systematics and life-history (in the widest sense of the word) of the insects concerned, and that to attain the best results from our labours the three branches of systematic, life-history and applied work must go hand-in-hand. Systematic or life-history work are each valuable in themselves and can be pursued as separate subjects, but the knowledge so attained can only be regarded as comparatively useless if merely gathered for its own sake and not applied to helping on the Great War against Waste in which we are constantly engaged with the Insect World. Economic work, considered solely by itself, tends to become mere eye-wash and perfunctory routine, and the so-called economic worker 'who has no use for' systematic work is always liable to make serious mistakes by his failure to distinguish between closely-related insects. But, if all the three branches are considered together, each will be found to afford to the others that mutual help which makes for real advances in knowledge. In this way, even the pure systematist, provided of course that the results of his work are available, may be regarded in one aspect as an economic worker of the greatest assistance to the economic worker who is not too rabidly a pure economist to despise such help."

In connection with a paper on the sexual armature of certain Anthomyiad Flies, Mr. Fletcher referred to the importance of a study of these elaborate structures in the identification and classification of insects and pointed out that future work in this direction will reveal in many cases an unexpected complex of species really diverse but superficially identical, and that such discrimination is of great practical importance in applied work. In the case of the Indian species of *Sarcophaga* also, which cannot at present be separated on external characters, the structure of the armature enables us to separate out about thirty species as distinct by this character.

Referring to a paper on Insects used as food in Burma, Mr. Fletcher gave several examples of similar cases in other parts of the World and pointed out that insects when taken as human food can only be used occasionally, either by themselves or with other kinds of food, as man is too bulky an animal to be wholly insectivorous. But, besides their use as food, insects are sometimes eaten or used by man for their supposed magical properties, by which they are assumed to possess qualities or properties which may be useful to man. In this way, queen termites are often eaten in India for their supposed aphrodisiac qualities, the extreme fertility of the insect being supposed to be communicated to the man who swallows it. In other cases magical ceremonies may be performed in order to increase the numbers of an insect used as food, or insects may be used as charms to prolong life, to bring back a runaway slave, or to circumvent destiny by substituting a mock calamity for a real one. Insects are also used in connection with negative magic, or taboo, as in some parts of Laos, in Annam, where all who engage in the practice of gathering lac abstain from washing themselves and especially from cleansing their heads, lest by removing the parasites from their hair they should detach the lac insects from the trees. Magic is closely allied to primitive religion and an example of the confusion of magic and religion is afforded by the present-day use in India of spells or *mantrams* to prevent insect pests from doing damage to crops, in which case their employment is another example of the use of magic in connection with insects, so that the spells, originally launched to coerce the superhuman being responsible for the control of insect plagues, may develop into exorcisms, either spoken or written, made in the name of a deity. Sometimes the desired end of reducing loss by the insect pests affecting his crops and his cattle is attained by primitive man by conciliating them by worship or sacrifice, or by treating with high distinction one or two chosen individuals of the obnoxious species, the rest being pursued with relentless vigour. In some cases also the expulsion of insect pests, which may be considered to take the form of devils, may take place periodically; thus, in India the Khonds expel the devils, which were apparently

originally the insect pests of stored grain, with appropriate magical ceremonies at seed-time. Such are a few instances of the connection between Insects and Magic. Probably many other cases occur in India and would be of considerable interest if collected together.

Section I of the programme, dealing with Agricultural Entomology, included two dozen papers, most of which were of technical interest. Mr. Afzal Husain, Government Entomologist, Punjab, gave an account of his work on parasites of Cotton Bollworms, and noted that thirteen parasites had been found to attack *Earias insulana* but that hitherto it cannot be said that these parasites keep the Bollworms in check or seem likely to provide a workable method of control. Another parasite, whose life-history has been worked out at Lyallpur, is *Tetrastrichus radiatus*, a Eulophid parasite of *Euphalerus citri*, a Psyllid pest of orange plants. Dr. Kunhi Kannan described a method of control of *Diatraea* sp., a cane-borer in Mysore, by placing in the fields small heaps of cane-trash in which the moths took shelter and where they could be collected and destroyed by daily examination of the heaps. Two papers on rats dealt with these animals as crop-pests in the Punjab and in Burma and both emphasized the enormous losses to the cultivators caused by rats. The use of poison baits, although giving very successful results in field trials, requires too much supervision to be practicable on a large scale, and fumigating machines, of a simple type, seem to promise better results, but to achieve any real success co-operation and active self-help on the part of the cultivators are essential. Two papers dealt with crabs as crop-pests in Madras and in Burma, the latter paper describing a successful method of trapping crabs in large, wide-mouthed earthenware pots, about ten to twelve inches high, sunk in the ground and baited with a mixture of fried oil-cake and fine rice-husk dust, about five crabs per pot per night being trapped on the average, over twenty thousand crabs being thus caught in one locality in three months. An outbreak of *Nephantis* on coconut-palm in Mangalore was described, the pest having been introduced into this area by coconut seedlings imported by rail from an infested district.

In a paper on Bud and Boll shedding in Cotton, Mr. G. R. Hilson showed the proportions of buds and bolls that can be definitely assigned as shed on account of insect attack and that a large proportion of this shedding is still due to unknown causes. In a paper on the American Cotton Boll-weevil, Mr. Bainbrigge Fletcher drew attention to the fact that this insect is at present a menace to cotton-growing as there is considerable danger of its importation into India with bales of American cotton brought over from the infected area in the Southern States. After a general discussion regarding this danger and the best means of obviating it, the Meeting passed a Resolution that "The Conference of Entomologists at Pusa, having considered the suggestion made in Dr. W. D. Hunter's communication, of determining 'by certificate or warehouse receipts that the cotton was more than six months old,' and having concluded that this will not afford adequate protection against the danger of introducing the Cotton Boll-weevil, is of opinion that the Indian Central Cotton Committee should consider the advisability of recommending the total prohibition of importation of cotton from America; and, as an alternative, that all bales containing such cotton should be fumigated at the port of entry and that entry should be restricted to Bombay."

In Section II (Forest Entomology), Dr. C. Beeson, Forest Entomologist, read a very interesting paper on the geographical distribution of *sal* borers, the discussion on which brought out many facts relative to the means of dispersal of insects and climatic barriers to natural distribution. A second paper, also by Dr. Beeson, dealt with current work in Indian Forest Entomology and showed how some control methods, based on entomological research on life-histories, can be made effective to control pests of forest trees. The discussion on this paper centred principally on the predaceous habits of Brenthid beetles, on the distribution and life-history of the Teak Bee-hole Borer (*Duomitus ceramicus*) and on the attraction of beetles to injured or felled trees.

Section III (Medical and Veterinary Entomology) included eight papers which attracted several additional visitors especially interested in the subject of Sanitary Entomology. Mr. M. O. T.

Iyengar described the occurrence of a Coprid beetle (*Caccobius mutans*, Sharp) in the human intestine in the Faridpur district and discussion centred chiefly on the method of infection, in which connection it is perhaps significant that the great majority of the beetles in this and other cases have been females whilst no immature stages have been found. Mr. Fletcher drew attention to the paucity of information regarding the fauna of animal excrement in India and the importance of work on this subject from a sanitary aspect. Mr. Iyengar's paper on the rôle of cattle in the prevention of malaria reviewed the present knowledge of this subject and endeavoured to classify the Anopheline mosquitoes in accordance with food preferences; this paper was followed by considerable critical discussion and the general sense of the Meeting inclined to the view that the use of cattle for the prevention of human malaria is impracticable. Mr. T. M. Timoney read a paper on the life-history and control of the Sarcoptic mange parasite of the buffalo, this paper being only the commencement of the study of the important parasites causing mange in domestic animals. In a short paper, Mr. Bainbrigg Fletcher showed that carbon bisulphide is not efficacious as a mosquito larvacide, as has recently been claimed in America. Mr. S. K. Sen, in a paper on *Aedes (Stegomyia) albopicta*, dealt with various observations on its bionomics and anatomy.

Section IV (Household and Store Pests) only included one paper, by Mr. Harnam Dass, on Air-tight Storage of Grain, in which was pointed out the difficulty of ensuring really airtight storage under practical conditions. There were no papers offered under Section V (Bee-keeping). In Section VI (Lac), Rai Bahadur C. S. Misra dealt with *Eublemma amabilis*, a Noctuid moth which is a serious predator on lac-insects, and Mr. S. Mahdi Hassan submitted the titles of two papers dealing with agamogenesis and sex-differentiation in lac-insects. Section VII (Silk) only contained one paper, by Mr. C. C. Ghosh, giving an account of the present position of sericulture in Burma.

In Section VIII (Life-histories and Bionomics) eleven papers were presented to the Meeting. Mr. M. Afzal Husain read a short

note on the life-histories of the Mango-hoppers (*Idiocerus*) which are serious pests of mango in the Punjab. In the ensuing discussion Dr. Kunhi Kannan pointed out that in the Punjab there appears to be only one breeding season, in February-March, but in Mysore there is a flush of mango leaves in July or October, of which these hoppers take advantage to start breeding, and that, with regard to winter spraying, the difficulty in Mysore is that a large number of the hoppers may not be on the mango trees at that time, but occur on other trees and bushes. Major R. W. G. Hingston read a very interesting paper on the evolution of the faculty of communication in Ants, in which he showed the development of this faculty from simple cases in which an ant which has discovered a food-supply leads another individual to its find, to more complex cases in which the news of the find is transferred to other ants in such a way that they are able to locate it without the further guidance of the original discoverer. Mr. T. V. Ramakrishna Ayyar had papers on the common social wasp, *Vespa cineta*, and on various insects from South India, whilst Rao Sahib Y. Ramachandra Rao gave a further contribution to the knowledge of South Indian Grass-gall midges and, in collaboration with Mr. Ballard, a paper on life-histories of certain Anthomyiad flies found in cereals and rotting vegetable matter.

In Section IX (Collection and Preservation), there was only one paper, by Mr. B. P. Uvarov, on the collection and study of Indian Orthoptera, in which he pointed out the numerous errors contained in the *Fauna* volume on grasshoppers and appealed for further material to enable a new revision of the Indian species to be as complete as possible.

Section X (Systematic Entomology) contained ten papers, mostly of technical interest, the only ones dealing with more general questions being a comparison by Major F. C. Fraser of the dragonfly fauna of the Palni and Nilgiri Hills, and a review by Mr. R. Senior-White of recent progress in our knowledge of the Indian Diptera, in the course of which he gave his experiences on a rubber estate in Ceylon, where, as the result of the completion of a survey of mosquito breeding-places which enabled a scheme of anti-mosquito

campaign to be devised and put into action, whereas during 1919 the labour force experienced 1,147 separate attacks of malaria, during 1922 only 87 attacks were registered and from July 1922 to January 1923 not a single attack of malaria, fresh infection or relapse has occurred in a force of over two hundred coolies, this successful result illustrating once again the value of what is primarily entomological research.

Section XI (Publications and Organization) included six papers, all dealing with organization from various aspects. Mr. Bainbrigge Fletcher, in a paper on Co-operation, dealt with the mutual relationships between entomological workers in India and the great advantages to all such workers of a centralized Institute for literature, collections and records of all kinds, and, failing the development of a centralized scheme for research, with the manner in which the various scattered workers can best make use of each other for the prosecution of their work, with due regard to the paramount interest of the country as a whole. In concluding this paper, after discussing various aspects of the relations between Pusa, the Provinces and other Departments, he said: "In any case, we must remember that Entomology deals with business problems and must be put on a business basis, and good business is based on good organization. It is up to us to show Government and the people of India that we are making the best use of the resources that we have to check the wastage of national wealth caused by insect pests, and we can only make the best use of our resources by mutual co-operation in our work." In a paper on Publicity for Entomology in India, Mr. Fletcher referred to the necessity of bringing results not only to the cultivator or other person known to be concerned in the application of results, but also to the general public, which may not be directly interested in one problem but which is directly interested, whether it knows it or not, with other facts regarding insect life. After discussing various methods of accomplishing this, he pointed out that at the present time we seem to be moving in rather a vicious circle, as, to do more work and thus reduce the wastage caused by insects, more funds are required to carry out research and demonstration and to bring results before the General Public, and to obtain

further funds the General Public requires to be convinced of their necessity. Mr. T. V. Ramakrishna Ayyar, in a paper embodying suggestions for future work in Economic Entomology, also dealt to some extent with the question of publicity, but advocated decentralization of entomological work in Madras, a view which did not meet with general acceptance by the Meeting. As most of the papers in this section covered much the same ground, they were all discussed together, and Mr. Fletcher, in opening the general discussion, remarked on the difficulty of impressing the cultivator with recommendations for treatment unless there be a solid foundation of research behind the advice given, as the cultivator is apt to ask for information on other questions than the one in hand and if the answers fail to satisfy is likely to conclude that none of the advice tendered is of much use. A general discussion then took place upon the question of the status of Entomology in Indian Universities and Agricultural Colleges, during which Dr. Kunhi Kannan urged that the diffusion of knowledge of Entomology should be more general and proposed the following Resolution, which was carried by a majority, *viz.*, that "this Meeting recommends to the Indian Universities that the subject of Entomology be taught as of equal rank with other branches of Biological Science in the courses of study for the Examinations of the Universities for Degrees in Science including Agriculture." In the discussion on co-operation there was general agreement regarding the need for a Central Institute for records and collections. Mr. Afzal Husain proposed that the Entomological Meetings in future should be held annually as a Section of the Indian Science Congress, but this proposal was opposed by many other speakers and found no acceptance by the Meeting; on the contrary, the following resolution, proposed by Dr. Kunhi Kannan, was discussed and passed unanimously, *viz.*, "That, in view of the great value of these Conferences to entomological workers in India and elsewhere, this Meeting is of opinion that the biennial Entomological Conferences should be continued in order to afford facilities to workers in all fields of entomological research to meet and discuss the work in their respective fields."

Section XII (Miscellaneous) is intended to include papers not falling conveniently into any other Section and under this heading was placed a paper by Mr. C. C. Ghosh on a few insects used as food in Burma. Under this Section also may be mentioned a highly interesting lecture, given by Dr. Kunhi Kannan, and illustrated by means of the episcopes, on entomological work in the United States, in which the lecturer gave an account of his visits to various entomological stations in America and of the work being carried on there.

Although, owing to financial stringency, absence on leave, depletion of staff and other causes, the Fifth Entomological Meeting missed the presence and aid of representatives from the Zoological Survey, the Indian Tea Association, the School of Tropical Medicine and several of the Provincial Agricultural Departments, the attendance and quality of the papers and discussions was well up to the average, and demonstrated once again that these Meetings serve a real need in stimulating that mutual confidence and mutual aid which is so desirable between all scientific workers, especially in a country such as India where these workers are so scattered and are often so isolated. It is hoped that the Sixth Meeting will see the presence of all those who were unavoidably absent from the Fifth and that this will prove another example of the truth of the old saying, "*Vires acquirit eundo.*"



BULLOCK IN STALL WITH AN APPARATUS FOR COLLECTING URINE.

A NITROGEN METABOLISM STALL FOR BULLOCKS.

BY

F. J. WARTH, M.Sc.,
Physiological Chemist, Pusa.

IN the usual procedure employed for collecting urine during nitrogen metabolism experiments, the animal has to remain in a standing position during the entire test.

The chief drawbacks to this procedure are :--

- (1) A test under such condition can only extend over a short period. Consequently there is no evidence to show how far the sample obtained deviates from the true average excretion of the animal.
- (2) Owing to restiveness under constraint and on account of exhaustion, the metabolism itself may be appreciably affected.

To avoid these drawbacks the arrangement described in this note was devised by the writer and set up at Pusa some months ago.

By its use the urine can be collected quantitatively for long periods (10-day tests have been carried out) without inconveniencing or tiring the animals in any way.

The apparatus (Plate VI) has proved itself of the greatest use and has enabled us to undertake a whole series of important experiments.

The main principle of the procedure is that, while the animal is allowed a considerable amount of freedom of movement and can lie down whenever it wishes to, it can only lie down on one side. If then the funnel and urine tube are directed to the other side of the

stall, they cannot be kinked or interfered with by the animal's body.

A gentle slope towards, and a deep depression near, one side of the stall suffice to make the animal lie on the other side. The contour stall plan (Plate VII) shows a suitable surface for the purpose.

On first entering the stall the animal may try both sides, but one or two experiences of the wrong side are sufficient to cure it. It cannot make itself comfortable there.

When this stage has been reached, the collection of urine may commence.

The usual waterproof funnel and rubber tube are used for the purpose.

To allow liberty of movement to the animal, the rubber tube must be made movable. This is effected by suspending the free end of the tube, with a weight attached to it, over a pulley, or rather reel. The tube then moves freely with the animal, any slack being taken up by the tension due to the weight. The extreme movement allowed in the Pusa experiments is 3 feet 6 inches.

Besides the horizontal reel, two upright reels are necessary to keep the tube in position and to prevent kinking or catching when the animal steps forward or backward.

The reel system will be more clearly understood by an examination of the accompanying diagrams (Figs. 1 and 2). The reels are entirely locally made, and of very light material. The spindles are made of $\frac{3}{8}$ " iron.

The height of the reel system with respect to the level of the stall is a very important point.

In order that the animal may not kick it, the tube must be kept as low as possible. This is attained by fixing the reels outside of, and opposite to, the depression, the top of the horizontal reel being level with the lowest point of the stall. The main portion of the tube then lies within the deep depression and cannot get in the animal's way.

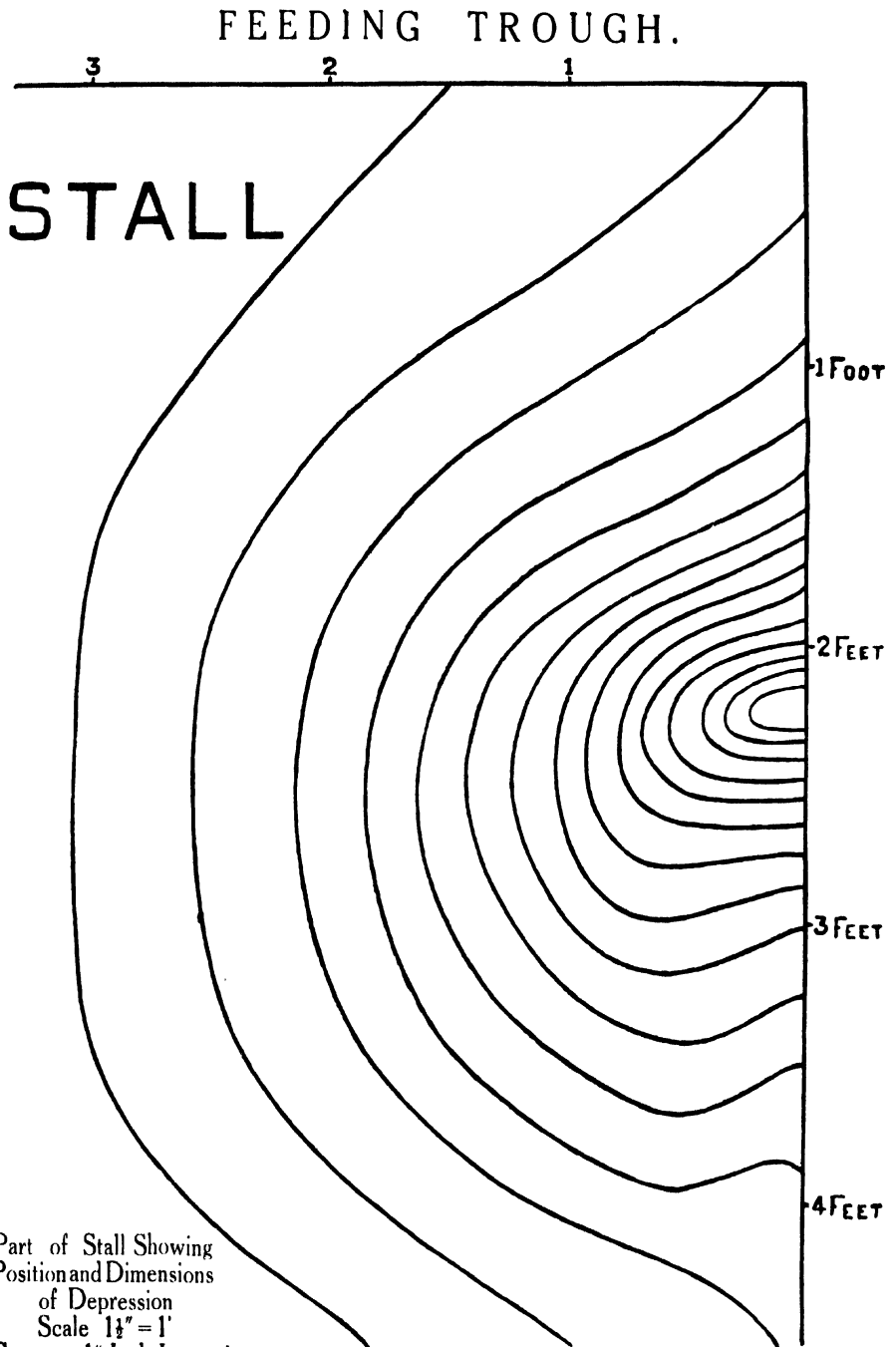

Another point which has to be attended to is the position of the waterproof funnel when the animal lies down. The floor is so shaped that under these conditions the funnel always slopes downwards and cannot retain urine. It may be remarked that even when the animal is lying down, the rubber tube (owing to the steep slope into the depression) does not touch the ground anywhere and is sensitive to the least movement on the animal's part.

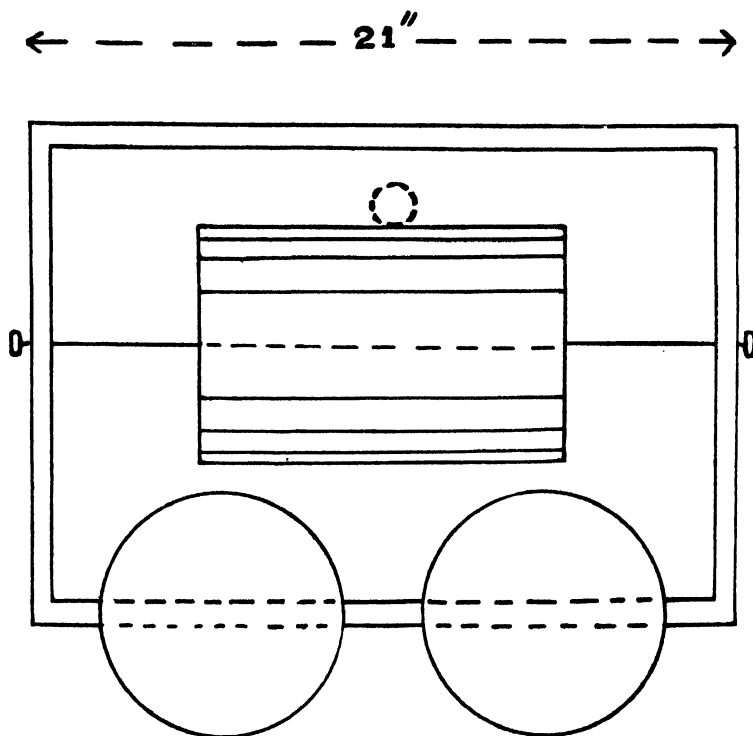

FIG. 1.—Position of the horizontal reel. The dotted circle shows the position of the glass tube.

For collecting urine, a pit five feet deep and adjoining the stall is required. In this pit and directly below the horizontal reel a wide glass tube is fixed in a vertical position. The rubber urine tube, weighted at the end, passes into and is free to move up and down in this glass tube. The glass tube passes through a small hole into the collecting vessel containing toluene. Clean unfermented 24-hour samples are obtained by this means.

It cannot be claimed that the method is absolutely safe. Losses do occur occasionally. Success depends upon the closest attention to such details as the size and shape of the funnel and its attachment,

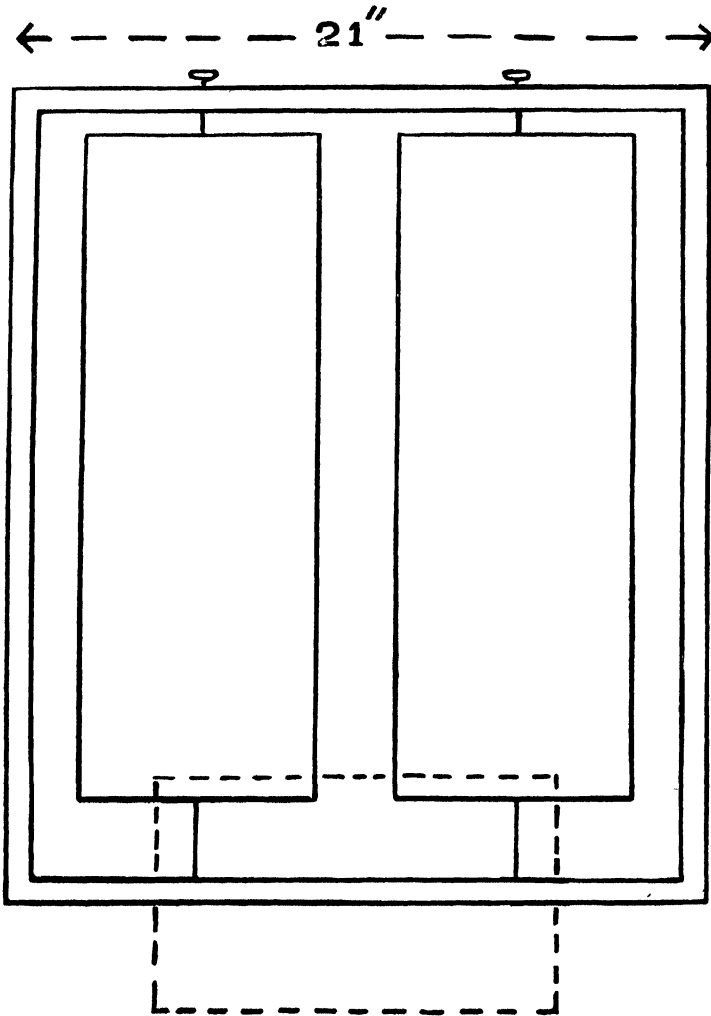

FIG. 2.—Vertical reels in front and horizontal reel behind.

the proper weightingⁿ of the rubber tube, the tying up of the animal, etc. If care is taken, failures are rare. The following experimental data have been added to illustrate the utility of the process.

A test, with two bullocks, carried out continuously for five days yielded the results shown in the table below :—

	BULLOCK A		BULLOCK B	
	Total urine in c.c.	Total nitrogen gm.	Total urine in c.c.	Total nitrogen gm.
1st 24 hrs. period	4,000	12·21	3,410	13·78
2nd „ „	4,220	12·10	3,980	14·19
3rd „ „	4,410	13·40	4,537	14·23
4th „ „	3,643	11·82	3,455	11·06
5th „ „	3,340	11·61	3,480	11·94

It will be seen that both animals gave a distinct maximum on the third day after which there was a marked fall. These changes are due to the climatic factor, which, it is evident, may be readily studied with the aid of the apparatus.

The same two animals, when on a much poorer diet, gave the following results :—

	BULLOCK A		BULLOCK B	
	Total urine in c.c.	Total nitrogen gm.	Total urine in c.c.	Total nitrogen gm.
1st 24 hrs. period	2,440	5·85	3,462	6·70
2nd „ „	2,210	5·76	2,770	6·12
3rd „ „	2,155	5·97	2,530	6·15
4th „ „	2,607	6·48	2,510	5·95
5th „ „	3,020	6·25	2,782	6·76

In each experiment the food given to the two animals was identical. Both tables show that the average urinary nitrogen excretion of bullock B was slightly greater than that of bullock A—a fact which could hardly have been established with certainty by a single 24-hour test.

THE WEALTH AND WELFARE OF THE PUNJAB*.

A REVIEW.

BY

A. C. DOBBS,

Director of Agriculture, Bihar and Orissa.

It is to be hoped that the title will not deter members of legislative bodies, or others, whose interest in Indian economics is not confined to the Punjab, from obtaining copies of this most excellent book. It has the somewhat rare distinction among books on economics of consisting mainly of arguments based on large numbers of simple and well established facts which all can understand and which are for the most part recorded in publications to which copious references are given in the text. The result is an admirably clear exposition of a large number of simple truths of universal application in Northern India, with which every one who wishes to be in a position to debate economic questions effectively or to vote upon them conscientiously should be familiar.

And if the book consists for the most part of destructive criticisms of popular fallacies, it is because so many economic fallacies are so generally popular—particularly among the public men to whose credit it is that their enthusiasm for Indian welfare is greater than their leisure for the extensive study of economics.

It is indeed almost inevitable that in a book of this kind, the principal object and necessity of which is to clear away a mass of misconceptions, there should be a tendency to preach rather than to prompt, to criticise rather than to inspire—a tendency,

* By H. Calvert, B.Sc., I. C. S., Registrar of Co-operative Societies, Punjab. Civil and Military Gazette Press. Price, Rs. 6.

however, which tempts the reviewer to look for weaknesses in the position of the author, even at the risk of himself appearing hypercritical.

The main theme of the book is the dependence of economic progress in the Punjab primarily on agricultural development, which, from the geographical position and the nature of her resources, must almost inevitably form the foundation of any considerable industrial expansion ; and the disadvantage to the Province, in these circumstances, of restricting the exports of wheat, and the doubtful advantage of taxing imported manufactures are clearly and fully set out. But the obstacles to economic development in all directions, presented by religious prejudices, social customs, and generally by existing conditions due to historical causes, are insisted on with a candour that almost obscures even the author's enthusiasm for co-operation as a panacea for rural deficiencies ; and the reader will find it difficult to trace beneath this mass of home-truths any other broad constructive ideas as to the lines on which economic development in the Punjab may safely proceed.

Experience unfortunately shows that preaching alone has little if any effect within any reasonable time ; ' must '—and there are seven ' musts ' in the first 13 lines of page 15—is far less effective than ' can ' and a complete justification of a candid exposé of existing defects demands not only an explanation of the causes to which those defects are due, but an explanation so satisfactory as to enable these causes to be negated by the application of the principles disclosed.

In this the author falls short. His attitude is fairly represented in the following passage. " To sum up the argument, it may be stated that the main causes of the poverty of the Punjab are to be found in the history of the Province. It should be sufficiently obvious that, if the mass of the people in any country are poor, it must be because they are not doing what is necessary to make them rich ; they are not using the factors of wealth in sufficient degree. From this it follows that what they are doing must be economically defective ; and so an inquirer must, if he is honest, catalogue a series of false omissions and defects.

“ There has been no systematic thrift resulting in the accumulation of vast wealth, such as is now found in the North-West of Europe. Such leaders as have arisen have been concerned with dynastic or religious matters, rather than with problems of increasing production. The general sentiments of the people have not run in favour of the steady accumulation of wealth ; on the other hand, they have been directed to the condemning of mere material welfare and the exaltation of things spiritual. Even now a mendicant excites more respect than an efficient artisan ; and thousands will listen to a policy of destruction who would remain unmoved by the advocacy of harder work and more efficient labour and skill as a panacea for common ills. The attitude of the people is still not towards material things. Further and connected with this, there is too much reliance upon a Higher Power and too little reliance upon individual effort in struggling along the lines fixed by that Higher Power. Government or God is expected to make good all the deficiencies of the people. Until it is absolutely burnt into the minds of every one that his economic position is mainly his own fault, there can be little improvement. The spirit of self-help must be nursed into a position of dominance.

“ There being no savings inherited from generations gone by, there is no capital earning incomes for the present. In the absence of capital there is wanting the development of the ingenuity to use it to the best purposes. Intelligent direction of large sums has had no chance to grow.”

And though the author makes several detailed suggestions as to what might be done in happier circumstances, and foreshadows, at the foot of page 209, a chapter of more comprehensive proposals, there is, after all, no inspiration to be found in the only remaining chapter, in which the question of ‘ Protection or Free Trade ’ is shortly discussed.

But a busy official has little time for literary work : the book represents an enormous amount of work that must have gone to equip the author for his office, and a perusal of the preface suggests that in its composition, largely from material which he had previously published over a series of years, he had wearied of an enquiry which

he found endless because he had become too stale to bring it to a wholly satisfactory conclusion.

And perhaps the book is after all more useful and stimulating for the fact that it sets a puzzle without giving an answer.* Granting that the immediate causes of relative poverty in a potentially rich land are those described, what are the fundamental possibilities of the situation, the exploitation of which might induce the people of the Punjab to mend their ways and to adopt an attitude of practical and energetic optimism? For if truth will have it that the economic position of every man is mainly his own fault, charity pleads that the faults of the poor man are no less explicable than the self-satisfaction of his more fortunate brother is forgivable while faith in the willingness of the spirit gives us hope that the weakness of the flesh can always be turned to good account.

Mr. Calvert himself attributes the fault ultimately to the history of the Province; but he appears to be diverted by its reactions on the character of the people from giving sufficient weight to the main characteristic of that history itself—which from an economic point of view is surely insecurity—and to its inevitable result. If easy conditions, a fertile soil, and a climate which allows of the production of two crops in a year, are not particularly conducive to thrift, yet a history of recurring periods when the mere possession of wealth made life itself insecure is surely one which should be used to illustrate the necessity of security as a condition in the absence of which thrift is hardly even a virtue.

The first and greatest economic aim of Punjab, and indeed of Indian, politicians should be such a guarantee of security of life and property as will give a reasonable prospect of the enjoyment of savings.

And is it not possible that the root of much of what Mr. Calvert condemns goes deeper even than history? The characteristic feature of sub-tropical climates such as that of Northern India is the extreme form in which Nature exhibits her forces. Of these extremes the Punjab gives good illustrations. The surface of a huge mass of mountains worn off and spread over an alluvial plain; a desert watered periodically by floods; extreme heat in summer

and frosts in winter ;—these are great manifestations of Nature's forces and can be turned to great account : but how helpless is the individual against their immensity ? Is it any wonder that where Nature adopts so arbitrary a mien man accepts her gifts with a philosophical resignation which, until he can contrive some comparatively effective system of control, is not unbecoming ?

Mr. Calvert in fact himself illustrates this view when he says in his Introduction, " On the great alluvial plains, a mere scratching of the fertile soil and a handful of seed will set the forces of nature to work at the production of a crop. Nature appears to be so bountiful that man need do little ; the land is the gift of nature ; and what nature provides, upon that man subsists. In England it is far otherwise ; the land itself was never so fertile ; as it exists at present it is almost entirely the work of man ; the average value of agricultural land is very little if any more than the value of the improvements carried out by its successive owners." But he hardly seems to grasp the significance of this contrast. The gifts of Nature in the Punjab are overwhelming, and the organization required on the part of man to increase them is proportionately great and difficult. It demands in fact united action on an enormous scale such as has only in recent years made possible the construction of a few great canals and railways.

And a realization of this ultimate fact, that individual insufficiency and exposure to foreign aggression are the peculiar dangers of India in general and of the Punjab in particular, surely gives one a different view-point from that represented by the statement that " political remedies will not cure economic ills."

The author, one feels, makes too little of the astounding development which his book reveals in the Punjab since the establishment of Pax Britannica ; and of the obvious fact that not only future progress but the maintenance of what has already been done depend entirely on a sane political ideal that will keep India strong and united.

On the other hand does he not also make too much of the faults, omissions, and defects which he catalogues, and which would almost certainly disappear in an atmosphere more favourable to

progress ? The influence of politics on economics extends beneath questions of external safety and internal unity : the whole question of the functions of Government in securing the accumulation of capital and guiding its use is essentially one for political discussion. Granted that the direct production of material wealth must be left to the energy of the man on the spot where it can be cultivated, and that centralized Government should concern itself only with first principles, there remain Knowledge and Judgment, the two greatest of the three elements that go to make up wealth, with regard to which the functions of Government have still to be defined. The discovery of truth, commonly called ' science,' and the wise selection of channels into which Energy can be safely directed, or in other words, constructive ' finance ' are perhaps not yet generally recognized, except partially in the United States, as essentially the functions of Government ; but to rule them out of consideration, as not matters of policy, would be to confine politics to law and political economy to statistics.

And the Punjab gives a particularly apt illustration of the impossibility of attempting so to limit the functions of Government. Nature confronts man's upward struggles not with a uniform incline but with a succession of considerable obstacles, greater perhaps in Northern India than elsewhere ; and experience has shown that man surmounts these physical obstacles not by increasing moral and spiritual superiority but by the more intelligent use of greater knowledge ; by contriving new and greater devices. Economic progress has consisted in the perception, magnification, and use of distinctive qualities ; not in the evolution of any system or creed, material or religious.

The Punjab is confronted with problems that are peculiarly wide and deep. The size of the Province compels action on an enormous scale, and the uniformity of its agricultural conditions opposes a hard unbroken crust to speculative ingenuity. Wages are higher in the Punjab than elsewhere in India, not because labour is more skilled but because the return for unskilled labour is greater ; and no mere increase of the productivity of the soil, by irrigation, manuring, or the evolution of more profitable crops and systems,

will have any ultimate result other than to increase the density of the population, unless the individual is first started on the ladder of diverging functions which is the essential element of agricultural as of all other industrial progress.

Profits in the face of competition depend on special skill or efficiency. The innovator in the Punjab has to compete with a mass of small holders with all their advantages in not having to hire, and watch, labour, and entrenched behind a well established system, on a fertile soil ; and only the concentration of large amounts of capital in intelligent hands and their devotion to a consistent ideal can survive the long experience of costly failures necessary to bring to economic fruition experiments in the adaptation of novel machinery to the vagaries of a trying climate, with the help of unskilled men.

The agriculture of the Punjab has been placed temporarily on an assured basis of profits, on the existing plane, by the rapid extension of irrigation ; but the differentiation of the functions of the agricultural labourer, which would make the exercise of organizing ability profitable, has not yet begun. The Punjab bullocks are larger than most Indian bullocks, and so earn higher pay for their driver ; but they will have to be yoked in larger teams, or other elaborate means of traction will have to be introduced, together with a system of laying out larger fields for efficient irrigation, before there is scope for intelligence in independent supervision of actual cultivation. The Punjab *goala* is perhaps the best in India, but he will have to be trained to look after and milk a cow that has yet to be produced before there is an opening for profitable dairy enterprise.

Towards such necessary concentration of capital in able hands the old system of ' might is right ' was effective. The newer system of sanctity of contract, under which the weak sell their freedom to the strong, is perhaps more effective still if it is allowed full play. The great landlords of England who, as Mr. Calvert says, initiated great improvements in European agriculture, became great under one or other of these systems. But the conscience of the world has revolted against unrestricted competition ; and the usurer who

would nevertheless become a territorial magnate, if not foiled of that ambition by legal restrictions, does not, as experience shows, interest himself in farming under an Indian sun. Who then but Government is in a position to patronise research into these fundamental problems of rural economics ?

Then again, the fact that the value of food, and of the perishable raw materials produced by agriculture, necessarily rises as they become more efficiently used, owing to the advance of science and economy in the production of the more durable materials of which machinery is constructed—this fact gives great scope for the development of small power-machinery for agricultural industries, such as the separation of oil, sugar, cotton lint, etc., near where the crops are grown ; so as both to save unnecessary traffic to and from further centres, and to retain a larger consuming population on the spot where the bulk of the things which they consume are produced. But no one who would care to manage such a small industry would have the large capital necessary to bring the initial experiments with the necessary machines to a successful conclusion, though once introduced there would be an unlimited field for intelligent improvement and organization. These and similar investigations come indeed already within the scope of the Agricultural and Industrial Departments, but the known scarcity of funds even for such vital matters as Defence and Public Health must of necessity restrict investigation on lines that would be immediately unprofitable, however full of ultimate promise.

Perhaps the most startling fact recorded in this book is the rise in the average price of land sold in the Punjab from 31 times its assessment for revenue in 1875, to 157 times that in 1916. Such a dissipation of economic resources among a population that has had no chance of learning thrift is surely impolitic and economically ineffective. Moreover, is it not unfair to the vast mass of the people, that those who are so fortunate as to obtain canal irrigated land should reap an enormous advantage while development generally is restricted by the necessity of paying high rates of interest ? It is really absurd that a Government should have to pay interest on borrowed money at all, when it could without difficulty

retain in its hands an amount of land revenue sufficient to put it in a position of a capitalist looking round for some means of investing profits.

If, after assimilating the facts so carefully recorded and the arguments so ably set out in Mr. Calvert's book, the representatives of the people of the Punjab, and indeed of India, will determinedly review the economic position and realize the formidable nature of the problems presented—so that, instead of crying blindly for protection from imports of manufactures and restriction of exports of food, they may insist that land revenue and water rates shall be adequately assessed and that funds shall thus be provided, free of interest, for the development of local resources and communications and for economic research—then indeed the “Wealth and Welfare of the Punjab” will have deserved its title and an honoured place in the libraries of India.

Selected Article

COTTON FROM THE GEZIRA.*

PROGRESS OF BLUE NILE SCHEME.

BY

SIR JAMES CURRIE.

FULL details of the Blue Nile Irrigation Scheme were published in the Egyptian Section of *The Times Trade Supplement* of February 1919. Readers will recall that the plans comprised the construction of a dam at Makwar, a main canal leading from the dam to that part of the Gezira plain to be irrigated, and a system of smaller irrigating canals.

Work was begun on the three operations in the autumn of the same year, but by June 1920, it became quite evident that the original estimate of expenditure, prepared after the Armistice, was likely to be exceeded, owing to the universal increase in costs resulting from the war. After a detailed examination of the figures, a revised estimate was drawn up in the following March. Subsequently, an independent expert was invited from England to visit and examine the works and prepare a report on the method and estimated cost of carrying out the scheme. His report was duly issued in February 1922. During all this period operations had gone steadily on and much had been accomplished, but at the date of this report funds were approaching exhaustion and the Sudan Government was not in a position to provide additional funds immediately. Consequently, by arrangement with the contractors,

* Reprinted from *The Times Trade Supplement*, dated 30th December, 1922.

who were working on a cost and percentage basis, the Government had perforce to terminate the contract, and operations were almost entirely suspended.

DATE OF COMPLETION.

Since then necessary arrangements have been made to provide funds, and a contract for the completion of the work was let last September. A number of firms were asked to tender, and the contract was secured by S. Pearson & Son, Limited, who submitted the lowest tender. This firm is now in charge of the work, which is to be finished in time for the planting of a cotton crop in July 1925.

The total area of the Gezira—the plain lying between the White Nile and the Blue Nile, immediately south of Khartoum—has been calculated at approximately 10,000,000 feddans (roughly as many acres). Of this area it is estimated from the general soil conditions and the results obtained during the last eleven years on the cotton-growing stations at Tayiba, Barakat and Hag Abdalla that a large portion of the area lying between the 14th and 15th parallels of latitude and comprising some 3,000,000 feddans is capable of growing cotton of high quality and of satisfactory yield. Further, the irrigation of this block presents no serious difficulties from the engineering point of view.

The area upon which a commencement is being made comprises a block of 300,000 feddans, in shape a rough oblong some 87 kilom. in length and averaging in width about $14\frac{1}{2}$ kilom. It begins at a point 57 kilom. north of the Makwar Dam and extends northward along and immediately to the west of the railway line from Sennar to Khartoum.

The first pumping station in the Gezira was established in 1911 at Tayiba, which is situated 11 kilom. north of Wad Medani. The object was to test the suitability of the Gezira soil under irrigation for the production of cotton and other rotation crops. The management of the Farm and the experimental work were placed in the hands of the Sudan Plantations Syndicate, Limited, which already had had considerable experience in the cultivation of cotton under irrigation in the Northern Sudan.

ACREAGE ALREADY PLANTED.

The area under cotton at Tayiba was rapidly extended, and has for some time now been about 2,000 feddans. In 1914, the syndicate, at its own expense, erected a new pumping installation at Barakat, a short distance south of Wad Medani, where some 2,000 feddans have since been planted with cotton every year. In 1921 a much larger installation was erected at Hag Abdalla, some distance south of Wad Medani. Last season there were 6,000 feddans under cotton at this station. The cotton acreage, therefore, last season comprised altogether some 10,000 feddans. The syndicate is now building yet another installation at Wad-el-Nau, which is situated still further south. In the 1922-23 season it is expected that there will be 10,000 feddans under cotton at Wad-el-Nau. All of these cotton-growing areas are situated within the area of 300,000 feddans already described.

Experiments have been made with all the standard Egyptian varieties of cotton and several long-stapled American sorts. The latter gave excellent returns, but extended experience has shown that Egyptian sakel is the most profitable cotton for the Gezira, and this is the sole variety now grown.

The most suitable time for sowing the cotton has been found to be the latter half of July or early August, and the crop is practically gathered by about the end of March. If rain falls in sufficient quantity after sowing, germination is ensured by that means; otherwise use is made of irrigation. Little resowing is required. That conditions are extraordinarily favourable to germination is evidenced by the fact that whereas in Egypt the usual seed rate for cotton is 1 ardeb ($5\frac{1}{2}$ bushels) to every 3 or 4 feddans, on the Gezira 1 ardeb is considered sufficient to sow 10 feddans.

The quality of the Gezira cotton has from the beginning been reported on with uniform favour. Referring to a sample submitted to him in 1918 a cotton expert described it as "excellent and as good as any cotton I have seen grown in Egypt; the staple is fine, long and regular, and it has remarkably little waste. The colour is slightly browner than Egyptian sakel, but this makes no difference to its value."

IMPORTANT POINTS.

The picking is done with great care, and as a consequence the grade is excellent. The whole crop is despatched to Liverpool for marketing, where a large proportion of it usually commands a premium on fully good fair sakel. As only one variety of cotton, *viz.*, sakel is grown, and as the ginning of the whole crop and the distribution of the seed are in the hands of one body, conditions are peculiarly favourable for the maintenance of quality and for the rapid dissemination of any improvement of strain over the whole area. So far, cotton on the Gezira has not been subjected to any very severe ravages by insect pests or by disease. The pink bollworm, which takes such heavy toll of the Egyptian crop, made its appearance in the Gezira some years ago, but it is quite a minor pest there and shows no tendency to get out of hand. Recent research carried out in Egypt with regard to the conditions of temperature and humidity, under which the pink bollworm thrives, confirms the view that it will never become a serious pest in the Gezira. On the whole, the Gezira is singularly free from cotton pests, and the occurrence between the end of March and late July of a dead season characterized by very high temperatures and very low humidity, when the plain is practically devoid of vegetation, furnishes ground for hoping that a similar degree of immunity will be enjoyed in the future. The maintenance of the existing practice of burning all cotton sticks as soon as the crop is gathered should serve as an additional safeguard.

TENANTS' HOLDINGS.

On the above cotton-growing stations, which are managed by the Sudan Plantations Syndicate, Limited, the land is all leased to tenants in blocks of thirty feddans, this being the unit which can conveniently be cultivated by a family of average size. Each block is worked on a three-year rotation, one-third of the land being under cotton, one-third under lubia, and one-third fallow. It is intended to apply this arrangement to the whole Gezira scheme, unless a more profitable rotation can be introduced. The question of the

employment of stock to feed off the leguminous crop would appear to merit more attention from the agricultural authorities than it has yet received.

With regard to the organization of settlements on the new irrigated area, it will be the rôle of the Sudan Plantations Syndicate, as the Government's agents, to supervise cultivation and generally manage the scheme. For this rôle, the Syndicate is particularly well qualified by its past experience. Nothing further, indeed, is required than the application of its present organization on the existing cotton-growing stations to successive 5,000 feddan blocks. Great importance is attached to the Syndicate's obligation to maintain an adequate staff to instruct cultivators and supervise cultivation. Already some 30,000 feddans comprised within the area of the scheme, and at present irrigated from the Syndicate's pumping installations, are under regular cultivation. In the summer of 1923, it is hoped that the Wad-el-Nau pumping installation scheme will embrace another 30,000 feddans. Hence, before the dam is completed, one-fifth of the total area covered by the scheme will have been organized, a large nucleus of tenants will have been trained in the cultivation of cotton, and the settlement of the remainder of the area greatly facilitated.

ADVANCES BY SYNDICATE.

New applicants for tenancies are in a large measure destitute of capital, and the Syndicate has to make advances for seeds, food, cattle, and implements. With regard to plough cattle and the heavier tillage implements, however, the Syndicate up to the present has considered that, instead of supplying these, it is a more economical and more efficient arrangement itself to undertake to break up, cultivate, and ridge tenants' land by steam tackle, which it does at cost price. Another great advantage offered to the tenants is the co-operative marketing of the cotton, and the arrangements for supplying them with good seed of sound strain.

If the hopes entertained of the Blue Nile scheme are realized and the preliminary inquiry and experiment have been of the most exhaustive character—it is impossible to exaggerate its importance

to Lancashire ; for, as Lord Stanley pointed out recently in the House of Commons, the future of the British cotton trade is intimately bound up with the handling of long staple, fine quality cotton. India and Japan may, in a future that is comparatively near, compete successfully in low-grade counts, but long generations will have to elapse before those countries can compete with the inherited technical aptitude and skill which Lancashire possesses and exhibits to the greatest advantage when handling higher counts.

HAIR LENGTH DETERMINATIONS OF JALAUH No. 1, CAWNPORE.
 (Received 1st August, 1922, Sledge Sorter.)

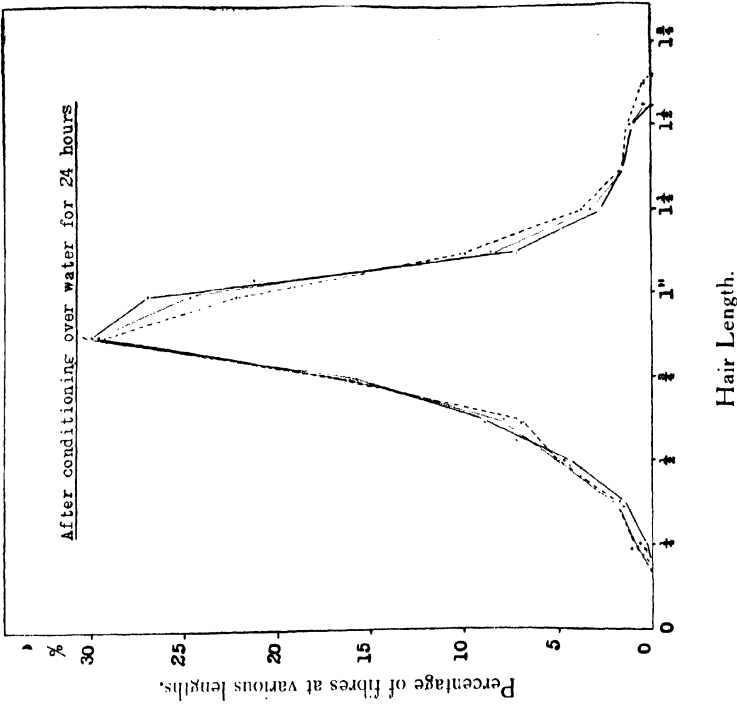
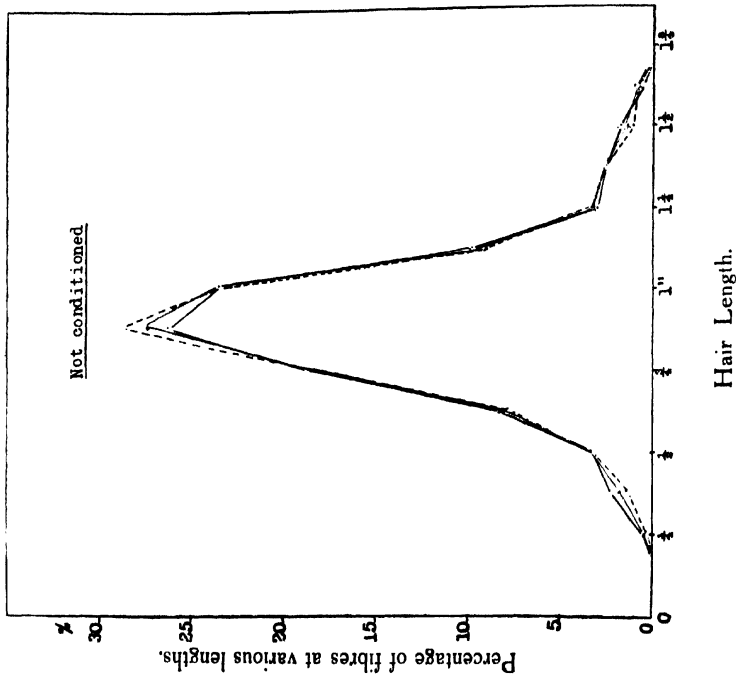

— 1st test, 2nd test, ——— mean of two tests.

Notes

THE DETERMINATION OF THE TRUE STAPLE LENGTH OF INDIAN COTTONS.

IN a recent number of this Journal, an abstract was published of a bulletin issued by the Research Department of the Fine Cotton Spinners' and Doublers' Association (Manchester) on spinning tests for cotton growers in which Dr. Balls drew attention to the physical measurements which it was possible to make on cotton fibre. The length of staple of a sample of cotton as judged by ordinary commercial standards is always a matter of opinion, whilst every plant-breeder working on cotton has been confronted with the difficulty of judging his productions for length and uniformity of staple.

As described by its inventor, the sorter mechanism is essentially an instrument for determining the proportion of cotton hairs of various lengths in a given sample. The "sledge" pattern is described in detail in a bulletin¹ issued by the Fine Cotton Spinners' and Doublers' Association, and it is sufficient to say here that a light sliver² is first prepared and approximately half a gram placed in the feed box of the sorter which is then traversed along a plush strip. Bundles of fibre of different lengths are deposited at different points on the plush; for accurate work these are removed and weighed on a micro-balance. For qualitative work a photograph or even the inspection of the strip is sufficient.

A most instructive report by Dr. Balls on the application of the sorter to the examination of strange cotton will be found in Mr. A. S. Pearse's recent book on "Cotton in Brazil."

¹ "A Method of Measuring the Length of Cotton Hairs," by W. Lawrence Balls. (Macmillan & Co., 1922.)

² A much lighter sliver is required in the case of short-staple cottons than when dealing with a cotton like Sakal.

We are indebted to the courtesy of the Research Department of the Fine Cotton Spinners' and Doublers' Association for the results of a test of a standard sledge sorter (as now manufactured by the Cambridge and Paul Scientific Instrument Co., price £50) on comparatively short-staple Indian cottons. The results of the test are shown in the attached frequency curves (Plates VIII and IX). For convenience, however, the results are summarized in the following table :—

Hair length in inches		PERCENTAGE OF HAIRS OF EACH LENGTH—(MEANS)			
		JN 1 un- conditioned	JN 1 conditioned*	Burma Wagyi (Card Sliver) unconditioned	Burma Wagyi (Card Sliver) conditioned*
$\frac{1}{8}$..	$\frac{1}{2}$	$\frac{1}{4}$	$\frac{1}{2}$	1
$\frac{3}{8}$..	2	2	$2\frac{1}{2}$	$2\frac{1}{2}$
$\frac{1}{2}$..	$3\frac{1}{2}$	$4\frac{1}{2}$	$5\frac{1}{2}$	5
$\frac{5}{8}$..	8	8	11	14
$\frac{3}{4}$..	$18\frac{1}{2}$	$16\frac{1}{2}$	$26\frac{1}{2}$	28
$\frac{7}{8}$..	$27\frac{1}{2}$	$29\frac{1}{2}$	28	$29\frac{1}{2}$
1	..	$23\frac{1}{2}$	$24\frac{1}{2}$	$13\frac{1}{2}$	12
$1\frac{1}{8}$..	$9\frac{1}{2}$	9	5	4
$1\frac{1}{4}$..	3	3	$3\frac{1}{2}$	2
$1\frac{3}{8}$..	$2\frac{1}{2}$	$1\frac{1}{2}$	2	1
$1\frac{1}{2}$..	$1\frac{1}{4}$	1	1	$\frac{3}{4}$
$1\frac{5}{8}$..	$\frac{1}{2}$	0	1	$\frac{1}{4}$

The history of JN 1 cotton, a pure line selection from the Bundelkhand cottons, has been described in Pusa Bulletin No. 123. This cotton has been shown by repeated full-scale mill trials to be suitable for 16s warps and 20s wefts in Cawnpore and for 18s warps under favourable conditions.

Burma Wagyi is an indigenous cotton on which the Agricultural Departments are now working and on which spinning tests have since been arranged. To obviate difficulties in removing leaf from

* Conditioned by standing over water for 24 hours.

HAIR LENGTH DETERMINATIONS OF THE BURMA WAGYI, CARD SLIVER.

(Received 1st August, 1922. Sledge Sorter.)

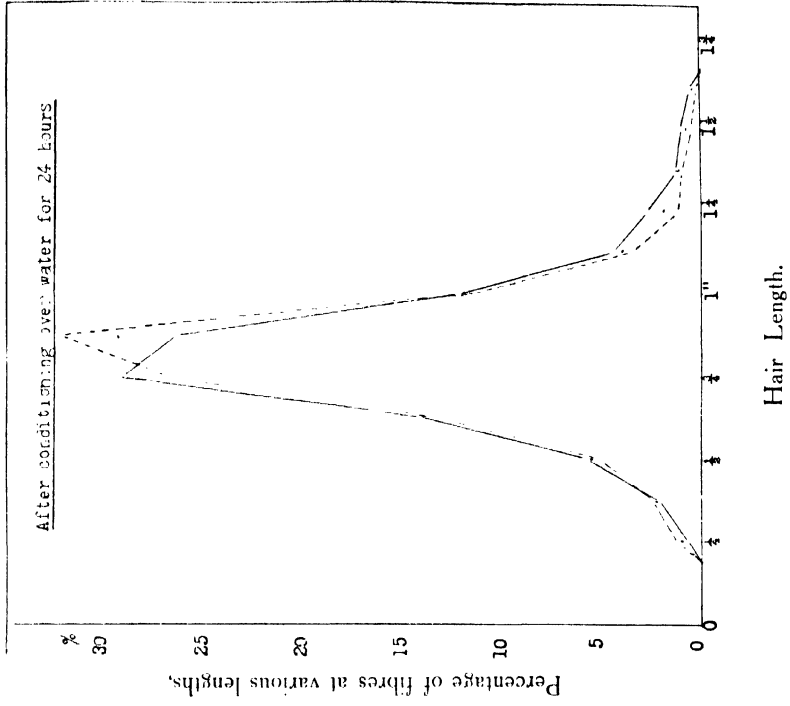
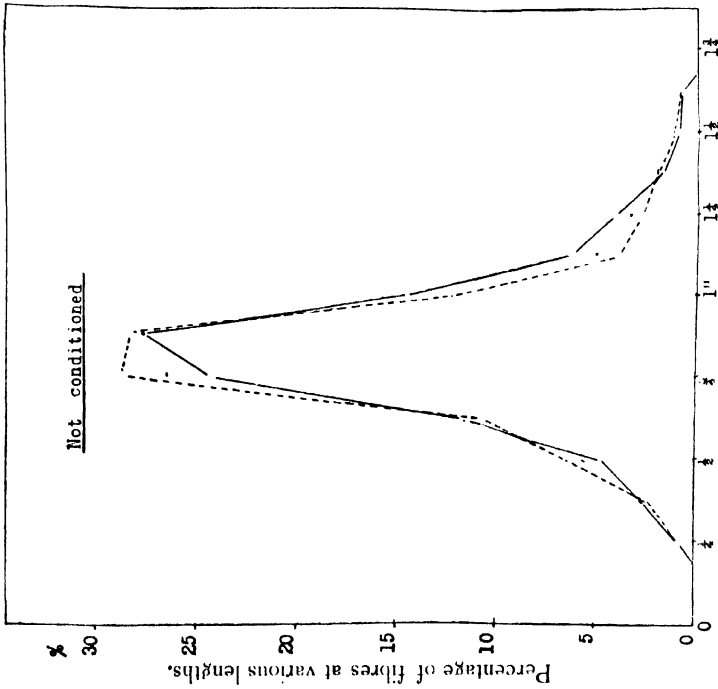

mean of two tests.

— 1st test, 2nd test.

SLEDGE SORTER EFFICIENCY TESTS.

25 hairs taken from plugh at various places, and the length of each hair measured exactly.

Below are frequencies of these lengths.

Short Staple Indian Cotton Jaijun No. 1, Cawnpore.

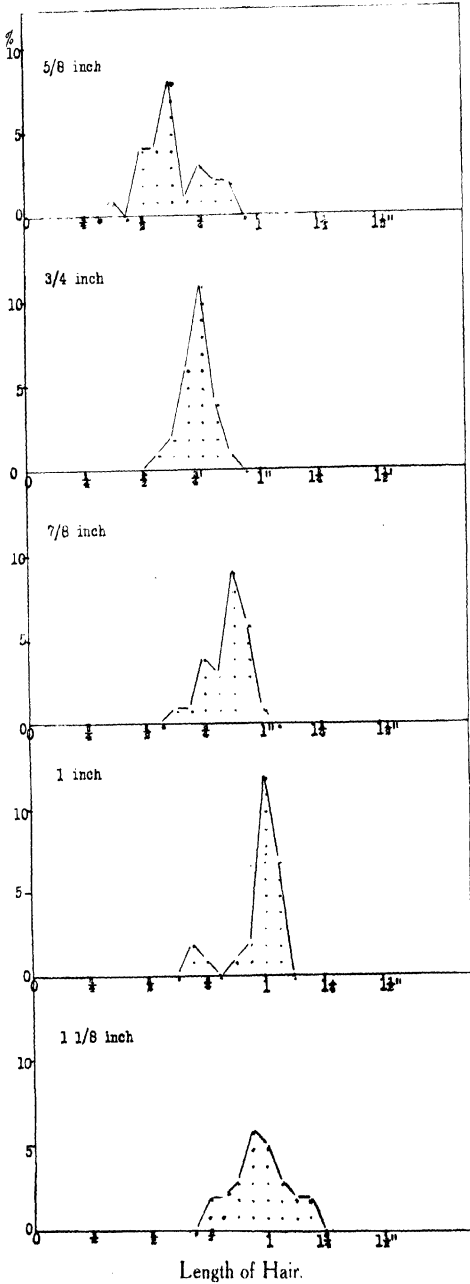

25 Egyptian Cotton, High Grade Sakel, Combed Shiver

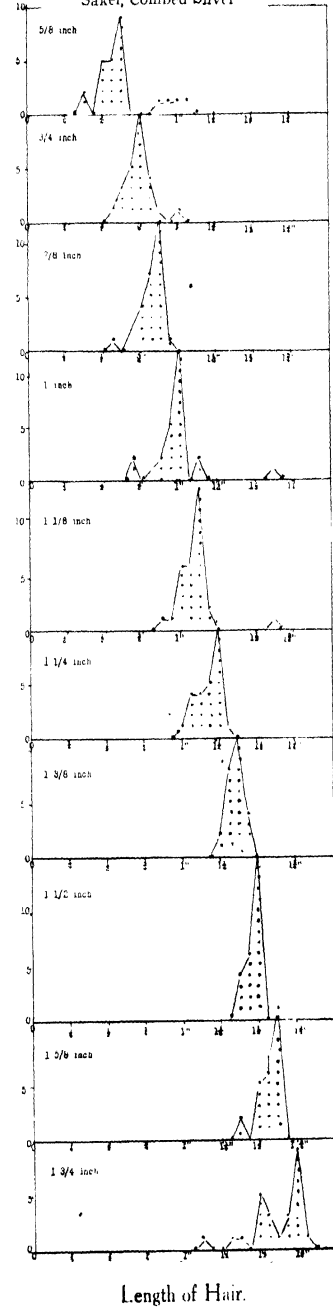

the sample, the experiment was conducted with a sample of card sliver prepared in an Indian mill. This though unobjectionable for the purpose for which these tests were intended would be better avoided in testing new cottons since the process of carding may materially alter the composition of a sample of cotton.

The second set of curves (Plate X) shows the results of a test of the efficiency of the instrument, carried out by actually measuring the length of 25 hairs from each of the fractions. From the test on Sakel (combed sliver) it will be seen that for the range for which the instrument was originally designed the efficiency was high, being 76, 80, 68, 72, 64, 92, 84 and 72 for the fractions $\frac{3}{4}$ " to $1\frac{1}{8}$ ". On JN 1 cotton the efficiencies for the $\frac{3}{4}$ ", $\frac{7}{8}$ " and 1" fractions were 84 per cent., 72 per cent. and 84 per cent. respectively. At $\frac{1}{2}$ " the efficiency was only 52 and the $1\frac{1}{8}$ " sorting was found unsatisfactory—due partly to the small size of these fractions. It would appear from the results that the sledge sorter in its present form is capable of giving very useful information concerning Indian cottons with a modal hair length of $\frac{3}{4}$ " to $\frac{7}{8}$ " and above. To secure the best possible results and to adapt the sorter for even shorter cottons it may be desirable to modify slightly the size of the rollers—a point now under investigation. Enough has probably been said to show that this instrument should be of considerable use to those engaged on cotton-breeding and that it may perform a useful function in the preparation of market standards.

A sledge sorter has now been purchased by the Central Cotton Committee and it is hoped to extend these results in the near future. [B. C. BURT.]

* * *

PROPAGATING THE SUGARCANE—SUCCESS FOR INDIAN METHODS IN CUBA.

READERS of this Journal will perhaps remember the one-bud system of planting sugarcane advocated by Mr. M. L. Kulkarni¹ of the Bombay Department. This consists of cutting the canes into sets of three nodes, removing the two end-buds and planting the

¹ *Agri. Jour., India*, Sp. Ind. Sci. Con. No. 1918, p. 125, and XIV, Pt. 5, p. 791.

set with the remaining live central bud pointing upwards. Very satisfactory results are reported from Cuba where the method has been tried. The table below gives the Cuban results:—

Yield in kg. per hectare.

Variety	Set with one eye-bud	Set with all its eye-buds
D 74	68,690	63,790
D 99	71,150	61,330
D 108	24,529	23,310
Uba	82,800	75,440
Crystalina	46,000	{36,000

It is a pity the area grown in each experiment is not stated.

The extract¹ from which the above table is taken strongly advocates the practice of letting the sets bud before planting with a view to choose the most vigorous shoots, and refers to the work done at Coimbatore.² [T. S. VENKATRAMAN.]

* * *

TESTING SPINNING VALUE OF COTTON.

THE spinning value of different grades, varieties, and conditions of cotton has been the subject of investigation by the Bureau of Markets and Crop Estimates of the U. S. Department of Agriculture for a number of years. The results of these investigations are obtained through exhaustive manufacturing and laboratory tests.

The cotton that is to be investigated is purchased by cotton experts of the Bureau of Markets and Crop Estimates and sent to different textile schools and mills throughout the country, where it is manufactured into yarn or cloth under the direct supervision of a corps of expert cotton-kill men employed by this Bureau. Particular attention is given to the manufacturing properties, especially the wastiness of the cotton, the bleaching and dyeing properties and the breaking strength of the yarn and cloth.

¹ *Inter. Inst. Agri. Monthly Bull.* Agri. Intelligence and Plant Diseases, March, 1922, No. 271.

² Venkatraman, T. S. and Thomas, R. The Care and Treatment of New Sugarcane Importations. *Agri. Jour., India*, XVI, pt. 1, p. 24.

LABORATORY EQUIPMENT.

Samples of cotton from the bale and of the stock from the different machines of the manufacturing process are collected and sent to the cotton-testing laboratory in Washington for various tests.

* * * *

The following apparatus is used : electrical moisture-testing oven, self-recording hygrometer, equal arm balance, umbrella reel, combination yarn and cloth testing machine, automatic humidity and temperature regulator, rack, single-strand testing machine, glass cage, single-fibre strength-testing machine, torsion-balance, yarn reel and yarn tester.

Laboratory tests of cotton and its manufactured products should, of course, be made under uniform atmospheric conditions, as variations in the moisture content of the stock tested will cause variations in the strength and sizings. The cotton-testing laboratory is therefore equipped with an automatic humidity and temperature regulator which controls the relative humidity at 65 per cent. and the temperature at 70 degrees F. The temperature, however, cannot be controlled when it is higher than 70 degrees F. outdoors. The actual conditions prevailing in the laboratory for both day and night are recorded by the self-recording hygrometer, which is checked at regular intervals throughout the day by a sling psychrometer.

TESTS FOR STRENGTH.

The yarn is tested for strength under the above conditions in the following manner : Twenty-four skeins of 120 yards each from different bobbins of the same lot of yarn are wound on the reel * * * and placed upon a pair of pegs of the rack * * *. This is continued until all the lots of yarn to be compared are reeled. The yarn is then allowed to remain on this rack overnight and broken in rotation the next day ; that is, one skein is taken from each pair of pegs from left to right so that all the lots will be broken at the same time and under a 65 per cent. relative humidity condition.

The skein is broken on either the combination yarn and cloth testing machine or on the yarn tester and the strength in pounds recorded. The broken skein is then placed upon the torsion-balance or on a direct yarn numbering quadrant, and the weight or size is determined and recorded.

The average of the 24 breaks gives the average break and the average of the 24 sizings gives the average size.* To offset slight variations in the weight or size* of the yarn of the different lots, a correction is made in the average strength in proportion as the average number varies from the desired number. When bleached or dyed skeins are tested by the skein method, the yarn is reeled from the umbrella reel instead of from bobbins.

The yarn may also be tested for strength by the single-strand testing machine. This machine gives the strength in ounces of a single strand and is used principally in determining the comparative strength of gray, bleached and dyed yarns. Other comparisons, however, may be made.

The single-fibre strength-testing machine is used to determine the average strength of individual fibres selected from the raw stock and from different machines of the manufacturing process.

The moisture-testing oven is used to determine the moisture content of cotton in the bale and at different points of the manufacturing process. This is important, as the invisible waste and the quality of the yarn are largely dependent upon this factor.

The equal arm balance is used for miscellaneous weighings in connection with work submitted to the Bureau. The glass cage is used for mounting fibres for projection purposes and for microscopic work.

PRESERVATION OF DUPLICATES OF THE ORIGINAL OFFICIAL COTTON STANDARDS OF THE UNITED STATES IN VACUUM TUBES.

The samples preserved were rolled in pure white paper and then in a black sheet. They were then placed in a tube with wads of

* Count.

cotton on the bottom and on the top. Loose asbestos was then placed on the top and this was covered with a compact wad of the same material. The tubes were later drawn down to a small aperture and mounted on the racks by an expert glass-blower. The cotton in each sealed tube is therefore protected from light and oxidation. A full set of these tubes is shown in the cotton-testing laboratory for educational purposes. [S. R. WINTERS: *Textile World*, LXII, 20.]

[*Note*.—Portions omitted refer to illustrations in the original article, not reproduced.]

* * *

SOME PHYSICAL MEASUREMENTS ON COTTON FIBRES AND THEIR GRAPHICAL REPRESENTATION.*

THE author has determined the length, diameter, breaking stress and extension at break of two samples of Egyptian cotton. Tests were carried out on 400 hairs selected at random from a half-pound sample of mill sliver, *i.e.*, 100 hairs for each property studied.

The method used for determination of hair length and diameter was that devised by Parker and Lewis, *viz.*, projection of an image on a white screen using a known magnification and measuring the image on the screen. For length a magnification of 16·2 was employed, for diameter 88.

The author shows that from a consideration of the numerical results no certain indication is obtained as to the relative value of the two cottons for spinning. When however the actual results are plotted and the curves obtained compared with a 'probability curve' constructed from Bateman's formula¹ much valuable information is obtained. The probability curve shows what experimental results might have been expected if they followed the law of probability for results having the same average value as those

* Barratt, T. *Jour. Tex. Inst.*, XIII, 10th October, 1922.

¹Bateman. *Phil. Mag.*, XX, 698, 1910. Probable frequency of occurrence = $\frac{x^n}{n!} e^{-x}$.

Where x is the average value of all the determinations, e the base of the natural logarithms, n can have all integral values in turn from 1 upwards.

given by experiment. By comparing the deviations of the actual result from the 'probability curves' one sample was seen to be markedly superior to the other in uniformity whilst the 'breaking stress' curve suggested that one sample possibly contained two distinct types of fibre.

The superiority of sample A was subsequently confirmed by other observations. [B. C. BURT.]

*
*
*

COTTON RESEARCH.

THROUGH the courtesy of the British Cotton Industry Research Association, the Secretary of the Indian Central Cotton Committee has sent the following abstracts for publication:—

DECAY OF COTTON HAIR.

SOME notes and plates illustrating the modes of weakening which may occur when the cotton hair is attacked by micro-organisms. From an examination of a very large number of hairs in all stages of infection and degradation, it would appear that the cotton hair is liable to attack at several points which in order of vulnerability are: (1) broken ends of the hair and deep cracks reaching the lumen, (2) abrasions, shallow cracks and 'pits,' (3) the normal surface of the hair or cuticle. It is shown that serious damage may exist in cotton before any indication of its presence can be detected by the usual tests and that one or two points of infection may seriously interfere with the spinning qualities of a hair. It is particularly important to guard against the possible development of micro-organisms in those processes such as conditioning which involve the addition of moisture to cotton. [*Trans. Text. Inst.*, 1922, 13, 240-248. H. J. DENHAM.]

EFFECT OF TEMPERATURE ON PLANT ROOT SYSTEM.

THE authors have studied the effect of high root temperature and excessive insolation on growth. Experiments are described which show that under average conditions of temperature and

sunshine the reduction of light due to overcrowding affects the growth of peas very seriously, but under conditions of very high temperature and prolonged intense sunshine crowded plants make the best growth. The two factors responsible for the injury of the spaced plants are prevailing high temperature and excessive power of the sun's rays, and further experiments were made to discover their relative importance. From the results obtained, it appears that a high degree of insolation is a more harmful factor than either high temperature or the actual total duration of sunshine. The results of another series of experiments indicate that root temperatures are of greater importance than atmospheric temperatures since good growth can be made in hot atmospheres provided the roots are kept relatively cool; it also seems probable that the minimum temperatures are of as much importance as the maximum temperatures. [*Ann. App. Biol.*, 1922, **9**, 197-209. WINIFRED E. BRENCHLEY and K. SINGH.]

COTTON CULTIVATION IN CHINA.

THE work of developing and improving the Chinese cotton crop, undertaken by the University of Nanking with the support of the trade, is described. Acclimatization of American cotton is practically accomplished and steps have been taken to ensure supplies of pure seed. New varieties of cotton have been developed and are proving satisfactory. The training of cotton workers is in progress at the University and efforts to introduce foreign implements have met with success. The pink bollworm is the most important pest at present. [*International Cotton Bull.*, 1922, **1**, 232-237.]

DESCRIPTION OF COTTON FUNGUS.

AN account is given of a disease of cotton which appeared in West Central Arkansas in 1920. The disease spread rapidly from the original centres of infection and in a short time killed many plants in the infected fields. All aerial parts of the plant were attacked except the flowers, and the fungus was found to cause a severe boll rot. Diseased material was collected in 1915 but

apparently no further notice was taken of it. In both seasons the outbreak was preceded by a period of unusual rainfall and humidity. The author isolated a fungus from infected material and was able to produce the disease by inoculation experiments. The life-history of the fungus and its characters, which apparently agree with descriptions of *Ascochyta gossypii*, have been determined, and it was found to live over winter in dead cotton stalks in the field and infect cotton plants the following spring. On this account rotation of crops is suggested as the most obvious remedy. [*Exp. Sta. Rec.*, 1922, 47, 447; from *Arkansas St. Bull.*, 1922, No. 178, 3-18. J. A. ELLIOTT.]

* * *

A STUDY OF FLAX AND KINDRED FIBRES.*

I. THE general recognition of the fact that 'bast' fibres have in themselves to some extent the structure of yarns, some with right-handed and some with left-handed twists, may be expected ultimately to have considerable influence on practical methods. Further, it is possible that a fundamental property of the fibres themselves, such as the natural tendency to twist appears to be, may be associated with other factors in determining what is at present rather vaguely referred to as 'spinning quality.'

Summary.

(1) Flax and ramie fibres always twist in a clockwise direction when drying; hemp and jute fibres twist in the reverse direction.

(2) Flax and hemp may therefore be readily distinguished from one another with the naked eye.

(3) Microscopic examination of the above fibres, after they have been subjected to a certain treatment, shows them to have a fibrillar structure; the fibrils in the case of flax and ramie are arranged in left-handed spirals, while in the case of hemp and jute they are arranged in right-handed spirals. (In some cases internal spirals with a reverse twist may occur.)

* Nodder, C. R. *Linen Industry Res. Association Res. Inst. Mem.* 7 and 9, 1922.

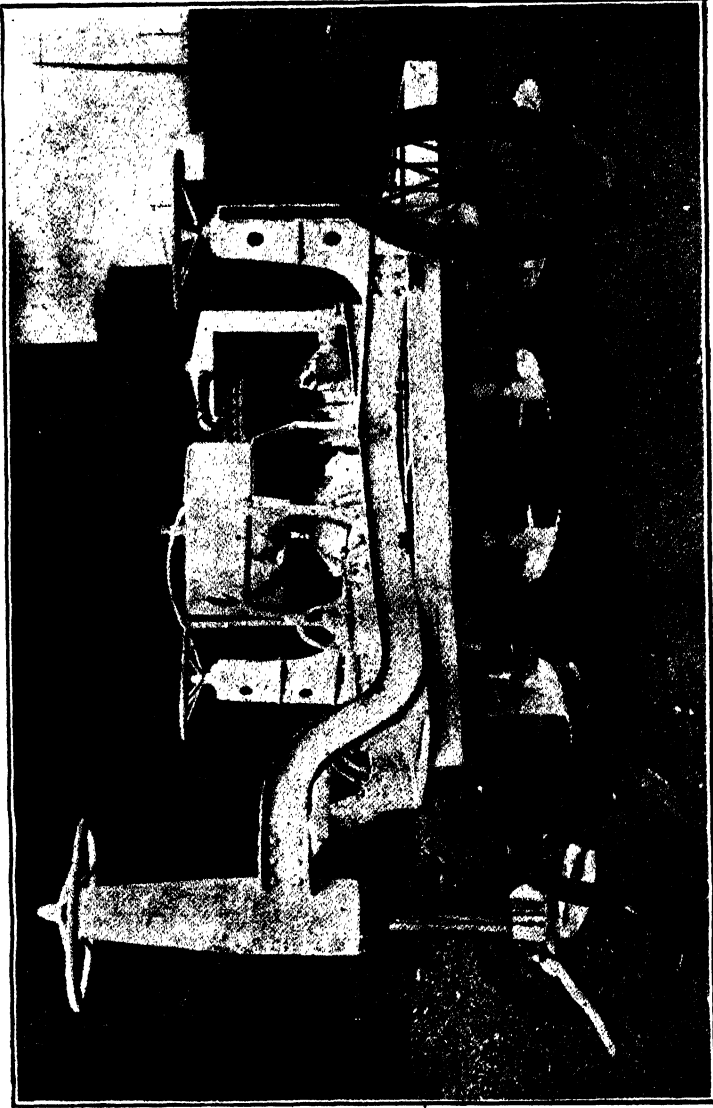

The spiral-cutter plough, showing the arrangement of the nine cutters.

(4) The drying of the above-mentioned fibres is therefore in all cases accompanied by a twisting up of the component fibrils. Conversely, moistening is accompanied by an untwisting of the fibrils.

(5) This tendency of fibres to twist may be expected to have an important bearing upon the properties of yarns.

(6) Attention is drawn to the possibility of explaining, in the light of the internal structure which has been revealed and the physico-chemical properties of cellulose, some of the characteristics exhibited by textile fibres.

II. Probable relationship between 'stomata' and 'slow spirals' of cotton and 'dislocation marks' of flax.

Summary.

(1) Flax and cotton fibres show a great similarity in structure despite the fact that they are not homologous; it is probable that the properties of cellulose play a large part in determining the architecture of vegetable fibres.

(2) Closely similar 'dislocation marks' occur in flax and cotton. The nature of the 'stomata' of de Mosenthal and 'slow spirals' of Balls is elucidated by a comparison of flax and cotton fibres.

(3) Both flax and cotton fibres have minute pores in the cell wall.

The author points out that the existence of an almost identical fibrillar structure in such diverse fibres as cotton and flax is in harmony with the assumption that the fibrils are the cellulose molecules. [*Jour. Tex. Inst.*, XIII, 9 and 10, Trans. Sept.-Oct., 1922.]

* * *

A NEW PRINCIPLE IN PLOUGHING AND ROAD SURFACING AND ICE SURFACING.

THE photograph accompanying this article (Plate XI) shows a spiral plough invented by Mr. Lytle S. Adams of Webster Grove, Mo., who, backed by years of experimenting and research on his

ranch, is now placing the machine—and a road shaver and a stump cutter that employ the same principle—on the market from East St. Louis, III.

The plough is designed to give the soil all of the benefits of its own natural nutrition, Mr. Adams claims, which is not possible by any other methods of soil cultivation now in use. It consists of nine spiral cutters or blades, located in a triangular shape, each following blade covering the soil just missed by the one in front of it. Right ahead of the last blades are the rear wheels, allowing them to run on firm ground, while the following blades plough the soil after them. The machine leaves in its wake a twelve-foot swath of soil, pulverized to a depth of 16 inches, if desired.

Each plough blade is constructed like an auger and made of the hardest cutting steel. The entering edge is smooth and sharpened while the rest of the blade consists of sections of teeth, like a saw blade, bolted on to the drill shaft so that they may be replaced when worn down.

The blades are operated by a continuous chain, driven by a 4-cylinder, 45-horse-power motor. They revolve at the rate of 200 to 600 revolutions per minute, according to speed desired.

By reason of its alternate blades turning in reverse directions, the plough will never clog in any soil; each blade has a tendency to clean the other. The revolving blades never strike an obstacle squarely, but with a rotary motion, so that the blade either moves it out of the way or shifts to one side itself. The plough may easily be pulled by a 10—20 tractor or, quite as readily, by six horses. Its own operation of blades revolving forward tends to cut its way through the soil, on the old principle of a circular saw, and is a distinct advantage as a cost saver in its assistance to the motive power.

The reason for the peculiar advantage of this plough, beside the time and economic advantage in finishing the soil for seeding, lies in the fact that nitrogen, which is the most vital part of soil nutrition, is found in the roots of vegetation, and, by turning over and harrowing, the soil is only provided with this property about

two or three inches in depth, whereas, the Adams plough takes every bit of vegetation and fertilizer and mixes it thoroughly with an even distribution throughout the depth of ploughing.

The rotary road shaver is a machine built on the same lines as the spiral plough. The principal difference between them lies in the position of the rear wheels. On the plough they are just ahead of the last blade, so that the solid ground the wheels run on may be ploughed after the wheels have passed; while on the road shaver the front wheel follows the first cutter and the rear wheels follow the last cutters, making possible a perfectly smooth traction on an evenly shaved surface of road. There are nine cutters, each driven by a continuous chain and rotating in reverse directions alternately. Thus the cutters assist each other and prevent chipping of an asphalt surface by precluding too much pressure in one direction and making the machine more easily guided and controlled, which would not be the case, were the cutters allowed to rotate in the same direction.

This machine is designed primarily for use on an asphalt-paved street or road that has been worn considerably in places and is full of small bumps. With its nine cutters revolving at a high rate of speed the shaver leaves in its wake a swath of smoothly planed surface of road twelve feet in width. It is claimed that a street in poor condition may be made as good as though the paving surface had just been laid. In addition, it would be a matter of only a few hours to put a sheet of ice in perfect condition with this machine. Last winter the shaver was tried out for this work in Chicago, and gave better results than were attainable in any other way. [E. M. STEVENSON: *Scientific American*, January 1923.]

* * *

JOURNAL OF THE EMPIRE COTTON GROWING CORPORATION.

WE have received the following for publication from the Secretary to the Empire Cotton Growing Corporation:—

It has been decided that the Corporation shall issue a quarterly journal which will contain particulars as to the activities of the Corporation, and thus serve to keep those interested informed as

to its work. It is hoped also to include information concerning cotton growing problems in all parts of the Empire, thus enabling the Corporation to act as a clearing-house of intelligence collected from different dominions and colonies, and to keep Directors of Agriculture and others engaged in cotton growing in touch with problems in which they are interested. Further, the Journal might contain statistics as to the cotton crops in different parts of the world, and their qualities and uses; while, finally, it is hoped that it may give spinners and growers a better knowledge of one another's requirements and difficulties.

To expand some of these suggestions slightly, the view of the Corporation is that the Journal should contain reports from all the cotton experiment stations in the Empire, giving particulars of the results obtained from each kind of seed, the nature of the soil, and the climatic conditions under which it was grown. The Corporation would do valuable work by collecting and disseminating such information so that the Agricultural Departments in the several colonies and dependencies can compare their own results with those obtained elsewhere, or, in the case of a country taking up cotton-growing anew, may be able to decide, on the basis of experimental results obtained elsewhere, which types are most likely to be successful under their own particular local conditions. With such an end in view the Corporation are considering the possibility of collecting and publishing details concerning the periods of growth and other characteristics which differentiate the several kinds of cotton. Such information is probably already available, but it is widely scattered. In addition, however, to collecting information already published under this head, the Corporation hope that Directors of Agriculture will co-operate with them by communicating to the Journal the results obtained at their experiment farms so as to bring the statement as far up to date as possible. The appearance of these results from experiment stations at regular intervals in the Journal, together with statistics from each country including acreage, yield, ginning out-turn and any other available details, would not only be of value to all cotton-growing parts of the Empire for the purposes of comparison, but would

show members of the Corporation the progress made from year to year. It is immaterial that most of the subject-matter of the first statement published would not be new; its chief value would be in the fact that it would all be collected in a form convenient for comparison.

It is hoped that other standing features of the Journal will be reports each season on the crops of each colony or dependency mentioning any administrative difficulties that had been encountered in growing or marketing the crop, and the steps that had been taken to surmount them. The Corporation venture to express the hope that these reports may be supplied through the courtesy of the Directors of Agriculture of the cotton-growing countries.

It is anticipated that the results obtained by the Corporation's research worker in St. Vincent will also be published periodically in the Journal, and also the reports of their cotton specialists in the several colonies, while special sections may be devoted later on to such matters as entomology and mycology relating to cotton. These sections should include reviews of any work done in these subjects, and the original sources of information would be quoted in case a reader needed fuller details.

It would probably be of interest also if it were possible to publish from time to time reports showing the growers' view of a particular bale of cotton, the brokers' valuation and description of it, and the results of spinning tests. Evidence given before the Empire Cotton Growing Committee shows that the brokers' reports alone are insufficient to enable the grower to improve his cotton or to vary the type so as to bring it into closer accord with the special requirements of the spinner who ultimately uses it. Reports, therefore, which trace a bale from the field through the ginnery and the brokers to the mill, if such could be obtained, would probably be appreciated by growers and by Directors of Agriculture.

It is also suggested that accounts of the agricultural processes and implements used in the several cotton-growing countries with discussions on their merits and defects would provide an interchange of information which may be of interest to the different agricultural departments.

Similarly, particulars as to any developments in transport systems and as to the practice of the various dependencies in such matters as handling, marketing and grading the crop may be usefully included.

It is hoped also to obtain permission to reprint such abstracts of current literature relating to cotton-growing as appear from time to time in the publications of the British Cotton Industry Research Association and in the *Journal of the Textile Institute*.

Finally, it is hoped that notes may appear from time to time giving particulars as to any members of the Colonial Agricultural Service who are home on leave, and meetings between them might be arranged at the offices of the Corporation. Discussion at such meetings should be of mutual benefit to those who take part, and would also be most useful to the Corporation's officers who would attend.

**PERSONAL NOTES, APPOINTMENTS AND TRANSFERS,
MEETINGS AND CONFERENCES, ETC.**

MR. R. B. EWBank, I.C.S., Deputy Secretary to the Government of India, Department of Revenue and Agriculture, has been appointed temporarily as Secretary in that Department, *vice* Mr. J. Hullah, I.C.S., reverting to the Central Provinces.

* * *

MR. G. S. HENDERSON, N.D.A., N.D.D., Imperial Agriculturist, has been granted leave on average pay for seven months from the 3rd April, 1923.

* * *

MR. M. WYNNE SAYER, B.A., Secretary, Sugar Bureau, has been appointed to act as Imperial Agriculturist, in addition to his own duties, during the absence of Mr. G. S. Henderson on leave.

* * *

MR. F. J. WARTH, M.Sc., Physiological Chemist, Pusa, has been granted leave on average pay for seven months from the 5th April, 1923, Mr. A. V. Iyer, B.A., officiating.

* * *

MR. K. McLEAN, B.Sc., Deputy Director of Agriculture, Bengal, has been appointed to act as Fibre Expert to the Government of Bengal with effect from the 17th October, 1922, *vice* Mr. R. S. Finlow, or until further orders.

* * *

RAI RAJESWAR DAS GUPTA BAHADUR, Deputy Director of Agriculture, Burdwan Division, has been allowed leave on average pay for two months from the 1st April, 1923.

MR. G. P. HECTOR, M.A., D.Sc., Economic Botanist to the Government of Bengal, has been granted leave on average pay for eight months from the 6th April, 1923, or any subsequent date.

* * *

MR. C. A. MCLEAN, M.A., B.Sc., has been appointed temporarily to be Deputy Director of Agriculture, North Bihar Range, and is posted to Sipaya in Saran.

* * *

MR. G. CLARKE, F.I.C., F.C.S., Agricultural Chemist to Government, United Provinces, has been granted leave on average pay for six months from the 1st April, 1923.

* * *

RAI SAHIB B. GANGA PRASAD has been appointed to officiate as Deputy Director, North-Eastern Circle, United Provinces, *vice* Dr. T. M. Singh, deceased.

* * *

MR. E. BALLARD, B.A., F.E.S., Government Entomologist, Madras, has been granted an extension of leave for seven months and twenty-four days in continuation of leave already granted to him and has been permitted to retire from the Indian Agricultural Service with effect from the date of expiry of the leave.

* * *

MR. P. H. RAMA REDDI, M.A., B.Sc., Deputy Director of Agriculture, III Circle, Bellary, has been granted leave for two months from or after the 15th March, 1923.

* * *

MRS. DOROTHY NORRIS, M.Sc., A.I.C., Government Agricultural Bacteriologist, Madras, has been granted leave on average pay for five months and twenty-three days from the date of relief.

* * *

MR. D. BALAKRISHNA MURTI GARU, Deputy Director of Agriculture, Madras, has been granted leave on average pay for four months from the 7th May, 1923.

MR. J. F. DASTUR, M.Sc., D.I.C., Offg. Mycologist to Government, Central Provinces, has been granted leave on average pay for one month and twelve days from the 19th March, 1923.

* * *

MR. A. MCKERRAL, M.A., B.Sc., Deputy Director of Agriculture, has been appointed to officiate as Director of Agriculture, Burma, *vice* Mr. J. Clague, I.C.S., proceeding on leave.

* * *

MR. L. LORD, B.A., Deputy Director of Agriculture, Burma, has been placed in charge of the Northern Circle, *vice* Mr. A. McKerral on other duty.

* * *

MR. F. D. ODELL, Deputy Director of Agriculture, Burma, has been placed in charge of the West Central Circle, *vice* Mr. L. Lord on other duty.

* * *

MR. J. W. GRANT, Deputy Director of Agriculture, Burma, has been placed in charge of the Myingyan Circle, *vice* Mr. T. D. Stock proceeding on leave.

* * *

MR. T. RENNIE, M.R.C.V.S., Veterinary Adviser to the Government of Burma, has been granted combined leave for two years and four months.

* * *

COLONEL G. K. WALKER, C.I.E., O.B.E., F.R.C.V.S., Principal, Punjab Veterinary College, Lahore, has been granted leave on average pay for two months from the 1st May, 1923, combined with the college vacation, Mr. W. Taylor officiating.

* * *

MR. H. E. CROSS, Camel Specialist, Sohawa, has been granted combined leave for two years, three months and twenty-eight days from the 5th April, 1923.

THE attention of Entomologists throughout the world is called to the fact that, beginning with the volume for 1922, the preparation of the "Insecta" part of the "Zoological Record" is being undertaken by the Imperial Bureau of Entomology. In order that the Record may be as complete as it is possible to make it, all authors of entomological papers, especially of systematic ones, are requested to send separata of their papers to the Bureau. These are particularly desired in cases where the original journal is one that is not primarily devoted to entomology. All separata should be addressed to : "The Assistant Director, Imperial Bureau of Entomology, 41, Queen's Gate, London, S. W. 7, England."

Reviews

Principles and Practice of Butter Making.—By G. L. McKay, D.Sc., and C. LARSEN, M.S.A. Third edition; largely re-written. Pp. xiv+406; figs. 133. (London: Chapman and Hall.) Price, 15s. net.

THIS is the third edition of what has long been regarded by English-speaking creamery butter-makers as a standard work and a standard work it undoubtedly is, being perhaps as good a sample as exists of a truly scientific work written by scientists for the use of practical men. The book is a useful one for butter-makers of any class, but it specially caters for the butter-factory manager and as there are few butter-factories in India, the book is not likely to have a large sale in this country.

The book is thoroughly up to date and deals with every phase of modern butter-making practice including the history of the industry, milk secretion, the properties of milk, the food value of milk and its products, ferments in milk, abnormal milk, variations in composition of milk and cream, receiving, sampling, grading and testing of milk and cream, creamery calculations, cream separation by hand and power, pasteurization, neutralization, ripening and churning of cream, salting and working of butter, marketing, grading and judging butter, cold storage of butter, chemical composition of butter, creamery economics, etc.

The book is carefully written and although it naturally gives prominence to American methods and practices, it is a valuable book of reference or study for the practical butter-maker or the dairy student. [W. S.]

Farm Buildings.—By W. A. FOSTER and D. G. CARTER.

Pp. xvi+378 ; Figs. 331. (New York : John Wiley & Sons, Inc. ; London : Chapman and Hall.) Price, 15s. net.

THE arrangement of the material groups the book into five divisions as follows : The farm barn ; other farm buildings ; the farm home ; general subjects ; and useful building information. The authors have largely drawn on their experience as farmers, experiment station workers and teachers, and an effort has been successfully made to pick out the practical and simple. We commend the book as a useful reference to those wishing to take up farming in the colonies. [EDITOR.]

NEW BOOKS

ON AGRICULTURE AND ALLIED SUBJECTS.

1. Farm Management, by R. L. Adams. Pp. 670. (London : Macmillan & Co.) Price, 20s. net.
2. Genetics in Relation to Agriculture, by E. B. Babcock and R. E. Clausen. Pp. 660. (London : Macmillan & Co.) Price, 20s. net.
3. Manual of British Botany: Containing the Flowering Plants and Ferns arranged according to the Natural Orders, by C. C. Babington. Tenth Edition. Pp. lvi + 612. (London : Gurney & Jackson, 1922.) Price, 16s. net.
4. Garden Animals : Friends and Foes, by W. D. Drury. Pp. 145. (London : Bazaar, Exchange and Mart.) Price, 2s. net.
5. Happy India as it Might be if Guided by Modern Science, by A. Lupton. Pp. 188. (London : G. Allen and Unwin, Ltd.) Price, 6s. net.
6. Breeding Crop Plants, by H. K. Hayes and R. J. Garber. Pp. 328. (London : Macmillan & Co.) Price, 17s. 6d. net.
7. Electricity in Agriculture, by A. A. Allen. Pp. x + 117. (London : Sir I. Pitman & Sons, Ltd.) Price, 2s. 6d. net.

THE following publications have been issued by the Imperial Department of Agriculture in India since our last issue :—

Memoirs.

1. Chemical Studies on Safflower Seed and its Germination, by V. A. Tamhane, M.Sc., M.Ag. (Chemical Series, Vol. VI, No. 7.) Price, As. 10 or 1s.
2. *Platyedra gossypiella*, Saund., Pink Boll-worm in South India, 1920-21, by E. Ballard, B.A., F.E.S. (Entomological Series, Vol. VII, No. 10.) Price, As. 12 or 1s.

3. Further Notes on *Pempheres affinis*, Fst. (The Cotton Stem Weevil), by E. Ballard, B.A., F.E.S. (Entomological Series, Vol. VII, No. 12.) Price, Re. 1 or 1s. 4d.
4. An Account of Experiments on the Control of *Siga (Schœnobius) incertellus* in the Godavari Delta, by E. Ballard, B.A., F.E.S. (Entomological Series, Vol. VII, No. 13.) Price, As. 14 or 1s. 4d.
5. *Hydrophilidæ* of India, by A. D'Orchymont; An Annotated List of *Ichneumonidæ* in the Pusa Collection, by G. R. Dutt, B.A.; A Second Note on Odonota in the Pusa Collection, by Major F. C. Fraser. (Entomological Series, Vol. VIII, Nos. 1, 2 and 3.) Price, Re. 1 or 1s. 6d.

Miscellaneous.

6. Catalogue of Indian Insects: Part 3—*Bombyliidæ*, by R. Senior-White, F.E.S. Price, As. 8.

**LIST OF AGRICULTURAL PUBLICATIONS IN
INDIA FROM THE 1ST AUGUST, 1922, TO
THE 31ST JANUARY, 1923.**

No.	Title	Author	Where published
GENERAL AGRICULTURE			
1	The <i>Agricultural Journal of India</i> , Vol. XVII, Parts V and VI, and Vol. XVIII, Part I. Price R. 1-8 or 2s. per part; annual subscription Rs. 6 or 9s. 6d.	Edited by the Agricultural Adviser to the Government of India.	Messrs. Thacker, Spink & Co., Calcutta.
2	Scientific Reports of the Agricultural Research Institute, Pusa, (including the Reports of the Imperial Dairy Expert and the Secretary, Sugar Bureau), for 1921-22. Price As. 14.	Issued from the Agricultural Research Institute, Pusa.	Government Printing, India, Calcutta.
3	Review of Agricultural Operations in India, 1921-22. Price R. 1-4.	Agricultural Adviser to the Government of India, Pusa.	Ditto
4	Methods of Examination of Certain Characters in Cotton. Pusa Agricultural Research Institute Bulletin No. 138. Price As. 8.	G. R. Hilson, B.Sc., Cotton Specialist, Madras.	Ditto
5	Estimates of Principal Crops in India, 1921-22. Price one-half anna.	Issued by the Department of Statistics, India.	Ditto
6	Prices and Wages in India. (Thirty-seventh issue). Price Rs. 2.	Ditto	Ditto
7	Agricultural Statistics of British India, 1920-21, Vol. I. Price Rs. 2-8.	Ditto	Ditto
8	Estimates of Area and Yield of Principal Crops in India, 1921-22. Price As. 8.	Ditto	Ditto
9	Report on the Operations of the Department of Agriculture, Bengal, for the year 1921-22.	Issued by the Department of Agriculture, Bengal.	Bengal Secretariat Book Depôt, Calcutta.
10	Report on the Crop Cutting Experiments during the quinquennium from 1917-18 to 1921-22. Price As. 9.	Ditto	Ditto

LIST OF AGRICULTURAL PUBLICATIONS—*contd.*

No.	Title	Author	Where published
<i>General Agriculture—contd.</i>			
11	Proceedings of the Meeting of the Board of the Agricultural Department, Bengal, held on the 20th April, 1922. (For official use only.)	Issued by the Department of Agriculture, Bengal.	Bengal Secretariat Book Depôt, Calcutta.
12	<i>Bengal Agricultural Journal.</i> (Quarterly.) (In English and Bengali.) Annual subscription R. 1-4 ; single copy As. 5.	Ditto	Sreenath Press, Dacca.
13	Report of the Department of Agriculture, Bihar and Orissa, for the year ending 30th June, 1922. Price As. 4.	Issued by the Department of Agriculture, Bihar and Orissa.	Government Printing, Bihar and Orissa, Patna.
14	Agricultural Statistics of Bihar and Orissa for 1921-22.	Ditto	Ditto
15	Report on the Administration of the Department of Agriculture of the United Provinces of Agra and Oudh for the year ending 30th June, 1922. Price R. 1-2.	Issued by the Department of Agriculture, United Provinces.	Government Press, United Provinces, Allahabad.
16	Report on the Agricultural Experiment Stations in the Central Circle, United Provinces, for the year ending 30th June, 1922. Price Re. 1.	Ditto	Ditto
17	Report on the Agricultural Stations in the North-Eastern Circle, United Provinces, for the year ending 30th June, 1922. Price As. 6.	Ditto	Ditto
18	Report on the Agricultural Stations in the Western Circle, United Provinces, for the year ending 31st May, 1922. Price Re. 1.	Ditto	Ditto
19	Report on the Agricultural Stations in the Eastern Circle, United Provinces, for the year ending 30th June, 1922. Price As. 14.	Ditto	Ditto
20	Season and Crop Report of the United Provinces of Agra and Oudh for 1921-22. Price As. 14.	Issued by the Department of Land Records, United Provinces.	Ditto
21	Tables of Agricultural Statistics of the Punjab for the year 1921-22.	Issued by the Department of Agriculture, Punjab.	Government Printing, Punjab, Lahore.

LIST OF AGRICULTURAL PUBLICATIONS—contd.

No.	Title	Author	Where published
<i>General Agriculture—contd.</i>			
22	Season and Crop Report of the Punjab for the year 1921-22. Price R. 1-8 or 2s.	Issued by the Department of Agriculture, Punjab.	Government Printing, Punjab, Lahore.
23	Graphs of Humidities and Temperatures connected with the Report on the Census of the Failure of the Cotton Crop in the Punjab in 1919.	Ditto	Ditto
24	Report on the Lawrence Gardens, Lahore, for 1921-22. Price As. 2 or 2d.	Ditto	Ditto
25	Report on the Cotton Survey in the Sialkot District.	D. Milne, I.A.S., Economic Botanist to Government, Punjab.	Ditto
26	Report on the Wheat Survey in the Muzaffargarh District.	Agha Yusuf Ali Khan, Assistant to Economic Botanist to Government, Punjab.	Ditto
27	Season and Crop Report of the Bombay Presidency for the year 1921-22. Price As. 9-6.	Issued by the Department of Agriculture, Bombay.	Government Central Press, Bombay.
28	Report of the Experimental Work of the Alibag Agricultural Station for the four years 1916-17 to 1919-20. Price As. 13.	Ditto	Yeravda Prison Press, Poona.
29	The Crops of the Bombay Presidency, their Geography and Statistics. Bombay Department of Agriculture Bulletin No. 109 of 1921. Price Rs. 2-13.	P. C. Patil, Deputy Director of Agriculture, South Central Division, Bombay.	Ditto
30	Year Book of the Agricultural Department in the Southern Division. Bombay Department of Agriculture Bulletin No. 110 of 1922. Price As. 5.	Issued by the Department of Agriculture, Bombay.	Ditto
31	Report on the Operations of the Department of Agriculture, Madras Presidency, for the year 1921-22.	Issued by the Department of Agriculture, Madras.	Government Press, Madras.

LIST OF AGRICULTURAL PUBLICATIONS—*contd.*

No.	Title	Author	Where published
<i>General Agriculture—contd.</i>			
32	A Soil Survey of the Periyar Tract. Madras Department of Agriculture Bulletin No. 84.	Issued by the Department of Agriculture, Madras.	Government Madras Press.
33	A Summary of the Results of the Experiments on Paddy conducted at the Manganallur Agricultural Station. Madras Department of Agriculture Bulletin No. 85.	N. S. Kulandai Swami Pillai.	Ditto
34	A Short Note on the Sirvel Agricultural Station. Madras Department of Agriculture Leaflet No. 18.	Issued by the Department of Agriculture, Madras.	Ditto
35	How to Produce Kolingi by Ryots in the IV Circle, comprising the districts of North Arcot, South Arcot, Chingleput and Chittoor. Madras Department of Agriculture Leaflet No. 19.	Ditto	Ditto
36	A Short Note on the Bantanahal Agricultural Station. Madras Department of Agriculture Leaflet No. 20.	Ditto	Ditto
37	Tillage. Madras Department of Agriculture Leaflet.	Ditto	Ditto
38	The Soil. Madras Department of Agriculture Leaflet.	Ditto	Ditto
39	Agricultural Meteorology. Madras Department of Agriculture Leaflet.	Ditto	Ditto
40	Report on the Working of the Department of Agriculture, Central Provinces and Berar, for 1921-22. Price Re. 1.	Issued by the Department of Agriculture, Central Provinces and Berar.	Government Nagpur Press.
41	Season and Crop Report of Central Provinces and Berar, for 1921-22. Price As. 8.	Ditto	Ditto
42	Return of Expenditure on the Provincial and District Gardens in the Central Provinces and Berar for the year ending 30th June, 1922.	Ditto	Ditto
43	Report on the Agricultural Stations in the Southern Circle, Central Provinces, for 1921-22. Price Ra. 2.	Ditto	Ditto

LIST OF AGRICULTURAL PUBLICATIONS—*contd.*

No.	Title	Author	Where published
<i>General Agriculture—contd.</i>			
44	Report on the Demonstration Work in the Southern Circle, Central Provinces, for 1921-22. Price As. 8.	Issued by the Department of Agriculture, Central Provinces and Berar.	Government Press, Nagpur.
45	Report on the Demonstration Work in the Northern Circle, Central Provinces, for 1921-22. Price As. 8.	Ditto	Ditto
46	Report on the Demonstration Work in the Western Circle, Central Provinces, for 1921-22. Price As. 8.	Ditto	Ditto
47	Report on the Experimental Farm attached to the Agricultural College, Nagpur, for 1921-22. Price As. 8.	Ditto	Ditto
48	The Manuring of Crops based on the Results of Experimental Work over the last 15 years on Government Farms. Central Provinces Department of Agriculture Bulletin No. 14. Price As. 2.	R. G. Allan, M.A., Principal, Agricultural College, Nagpur.	Ditto
49	Ensilage. Central Provinces Department of Agriculture Bulletin No. 17 (in English, Hindi and Marathi). Price A. 1.	S. T. D. Wallace, B.Sc., Deputy Director of Animal Husbandry, Central Provinces.	Ditto
50	The Consolidation of Holdings in its Relation to Conditions in Chhattisgarh. Central Provinces Department of Agriculture Bulletin No. 18. Price As. 2.	J. C. MacDougall, M.A., B.Sc., Officiating Deputy Director of Agriculture, Eastern Circle, Central Provinces.	Ditto
51	Import of Cattle for Draught and Dairying. Central Provinces Department of Agriculture Leaflet in English, Hindi and Marathi (for free distribution).	Issued by the Department of Agriculture, Central Provinces and Berar.	Ditto
52	Report of the Agricultural Department, Assam, for the year ending 31st March, 1922. Price As. 8.	Issued by the Department of Agriculture, Assam.	Assam Secretariat Printing Office, Shillong.
53	Report on Agricultural Demonstrations in the Assam Valley Circle for the year ending 31st March, 1922.	Ditto	Ditto

LIST OF AGRICULTURAL PUBLICATIONS—*contd.*

No.	Title	Author	Where published
<i>General Agriculture—conold.</i>			
54	Report on Agricultural Demonstrations in the Surma Valley Circle for the year ending 31st March, 1922.	Issued by the Department of Agriculture, Assam.	Assam Secretariat Printing Office, Shillong.
55	Report on the Agricultural Experiments and Demonstrations in Assam for the year ending 31st March, 1922. Price As. 12.	Ditto	Ditto
56	Tables of the Agricultural Statistics of Assam for 1921-22.	Ditto	Ditto
57	Season and Crop Report of Burma for 1921-22. Price R. 1.	Issued by the Department of Settlements and Land Records, Burma.	Government Printing, Burma, Rangoon.
58	Report on the Season and Crop of the North-West Frontier Province for 1921-22. Price R. 1-4.	Issued by the Revenue Commissioner, North-West Frontier Province.	Government Press, Peshawar.
59	Summary of Remarks on the Kharif Crop of the North-West Frontier Province for 1921-22. Price As. 7.	Ditto	Ditto
60	Annual Report of the Department of Agriculture, Baroda State, for the year 1920-21. Price R. 1.	Issued by the Department of Agriculture, Baroda.	Baroda Printing Works, Baroda.
61	<i>The Journal of the Madras Agricultural Students' Union</i> (Monthly). Annual subscription Rs. 2.	Madras Agricultural Students' Union.	Literary Sun Press, Coimbatore.
62	<i>Quarterly Journal of the Indian Tea Association.</i> Price As. 6 per copy.	Scientific Department of the Indian Tea Association, Calcutta.	Catholic Orphan Press, Calcutta.
63	<i>Poona Agricultural College Magazine</i> (Quarterly). Annual subscription Rs. 2.	College Magazine Committee, Poona.	Arya Bhusan Press, Poona.
64	<i>Journal of the Mysore Agricultural and Experimental Union</i> (Quarterly). Annual subscription Rs. 3.	Mysore Agricultural Experimental Union.	Bangalore Press, Bangalore.
65	<i>Indian Scientific Agriculturist.</i> Annual subscription Rs. 4.	Alliance Advertising Association, Ltd., Calcutta.	Bera & Co., Printers, Calcutta.
66	<i>The Planters' Chronicle</i> (Weekly).	United Planters' Association of South India, Coimbatore.	Daily Post Press, Bangalore.

LIST OF AGRICULTURAL PUBLICATIONS—*contd.*

No.	Title	Author	Where published
AGRICULTURAL CHEMISTRY			
67	Investigations on Indian Opium, No. 3. Studies in the Meconic Acid Content of Indian Opium. Memoirs of the Department of Agriculture in India, Chemical Series, Vol. VI, No. 6. Price As. 6 or 6d.	Harold E. Annett, D.Sc. (Lond.), F.I.C., M.S.E.A.C., Agricultural Chemist, Cawnpore, and Mathura Nath Bose, M.A.	Messrs. Thacker, Spink & Co., Calcutta.
68	The Hydrogen Ion Concentrations of Some Indian Soils and Plant Juices. Pusa Agricultural Research Institute Bulletin No. 136. Price As. 4.	W. R. G. Atkins, O.B.E., Sc.D., F.I.C., Formerly Indigo Research Botanist to the Government of India.	Government Printing, India, Calcutta.
69	The Determination of Prussic Acid in Burma Bean (<i>Phaseolus lunatus</i>). Pusa Agricultural Research Institute Bulletin No. 140. Price As. 3.	J. Charlton, B.Sc., Agricultural Chemist, Burma.	Ditto
70	The Nature of Changes occurring in the Indigo Steeping Vat. Indigo Publication No. 11. Price R. 1-10.	W. A. Davis, B.Sc., A.C.G.I., Indigo Research Chemist to the Government of India.	Ditto
BOTANY			
71	The Inheritance of Characters in Rice, II. Memoirs of the Department of Agriculture in India, Botanical Series, Vol. XI, No. 8. Price R. 1-4 or 1s. 8d.	F. R. Parnell, M.A., Ag. Dip. (Cantab.), Government Economic Botanist, Madras, with the assistance of G. N. Rangaswami Ayyangar, B.A., K. Ramiah, L.Ag. and C. R. Srinivasa Ayyangar, L.Ag.	Messrs. Thacker, Spink & Co., Calcutta.
72	The Wheats of Bihar and Orissa. Memoirs of the Department of Agriculture in India, Botanical Series, Vol. XII, No. 1. Price As. 8 or 9d.	Albert Howard, C.I.E., M.A., Imperial Economic Botanist, Gabrielle L. C. Howard, M.A., Second Imperial Economic Botanist, and Abdur Rahman Khan, Second Assistant to the Imperial Economic Botanist.	Ditto
73	Note on the Probability of an Inter-relation between the Length of the Stigma and that of the Fibre in some forms of the genus <i>Gossypium</i> . Pusa Agricultural Research Institute Bulletin No. 137. Price As. 4.	Ram Prasad, Officiating Assistant Economic Botanist, United Provinces.	Government Printing, India, Calcutta.

LIST OF AGRICULTURAL PUBLICATIONS—*contd.*

No.	Title	Author	Where published
MYCOLOGY			
74	A New Ginger Disease in Godavari District. Memoirs of the Department of Agriculture in India, Botanical Series, Vol. XI, No. 9. Price R. 1 or 1s. 4d.	S. Sundararaman, M.A., Government Mycologist, Madras.	Messrs. Thacker, Spink & Co., Calcutta.
AGRICULTURAL BACTERIOLOGY			
75	Comparative Manurial Value of the Whole Plants and the Different Parts of Green Manures. Pusa Agricultural Research Institute Bulletin No. 141. Price As. 6.	N. V. Joshi, B.A., M.Sc., L.Ag., First Assistant to the Imperial Agricultural Bacteriologist.	Government Printing, India, Calcutta.
ENTOMOLOGY			
76	Notes on Indian Diptera: (1) Diptera from the Khasia Hills, (2) Tabanidæ in the collection of the Forest Zoologist, and (3) New Species of Diptera from the Indian Region. Memoirs of the Department of Agriculture in India, Entomological Series, Vol. VII, No. 9. Price R. 1-12 or 2s. 3d.	Ronald Senior-White, F.E.S., Malariologist, The Kepitigalla Rubber Estates, Ltd.	Messrs. Thacker, Spink & Co., Calcutta.
77	An Entomologist's Crop Pest Calendar for the Madras Presidency. Pusa Agricultural Research Institute Bulletin No. 131. Price As. 2.	T. V. Ramakrishna Ayyar, B.A., F.E.S., F.Z.S., Assistant Entomologist, Madras.	Government Printing, India, Calcutta.
78	Report of Campaign against <i>Spodoptera mauritia</i> , Boisdu. (<i>Noctuidæ</i>) in Malabar. Pusa Agricultural Research Institute Bulletin No. 132. Price As. 2.	E. Ballard, B.A., F.E.S., Government Entomologist, Madras.	Ditto
79	Results of Investigation of Bionomics of <i>Platyedra gossypiella</i> , Saunders, in South India, together with some Notes on <i>Barias insulana</i> and <i>E. fabia</i> . Pusa Agricultural Research Institute Bulletin No. 133. Price As. 5.	Ditto	Ditto
80	Supplementary Observations on Borers in Sugarcane, Rice, etc. Pusa Agricultural Research Institute Bulletin No. 134. Price As. 6.	C. C. Ghosh, B.A., Assistant Entomologist, Burma.	Ditto

LIST OF AGRICULTURAL PUBLICATIONS—*contd.*

No	Title	Author	Where published
<i>Entomology—concl.</i>			
81	Some Observations on the Control of Field Rats in the Punjab. Pusa Agricultural Research Institute Bulletin No. 135. Price A. 1.	M. A. Hussain, M.A., Government Entomologist, Punjab, and Hem Singh Pruthi, M.Sc., Assistant Professor of Entomology, Punjab.	Government Printing, India, Calcutta.
82	List of Publications on Indian Entomology, 1920-21. Pusa Agricultural Research Institute Bulletin No. 139. Price R. 1.	Compiled by the Imperial Entomologist.	Ditto
83	Report on the Diseases of Silkworms in India. Price Rs. 3.	A. Pringle Jameson, D.Sc.	Ditto
VETERINARY			
84	Annual Report of the Imperial Bacteriological Laboratory, Muktesar, for the year ending 31st March, 1922. Price As. 9.	Director and First Bacteriologist, Imperial Bacteriological Laboratory, Muktesar.	Government Printing, India, Calcutta.
85	Studies in Rinderpest. Memoirs of the Department of Agriculture in India, Veterinary Series, Vol. III, No. 4. Price R. 1 or 1s. 4d.	W. A. Pool, M.R.C.V.S., Officiating Director and First Bacteriologist, Imperial Bacteriological Laboratory, Muktesar, and T. M. Doyle, F.R.C.V.S., Veterinary Officer, Imperial Bacteriological Laboratory, Muktesar.	Messrs. Thacker, Spink & Co., Calcutta.
86	Etiology of Equine Contagious Abortion in India. Memoirs of the Department of Agriculture in India, Veterinary Series, Vol. III, No. 5. Price As. 8 or 9d.	T. M. Doyle, F.R.C.V.S., Veterinary Officer, Imperial Bacteriological Laboratory, Muktesar.	Ditto
87	Annual Report of the Bengal Veterinary College and of the Civil Veterinary Department, Bengal, for 1921-22. Price R. 1.	Issued by the Civil Veterinary Department, Bengal.	Bengal Secretariat Book Depot, Calcutta.
88	Annual Report of the Civil Veterinary Department, Bihar and Orissa, for the year 1921-22. Price R. 1-8.	Issued by the Civil Veterinary Department, Bihar and Orissa.	Government Printing, Bihar and Orissa, Patna.
89	A Note on Flaying of Goats Alive.	Rai Sahib P. N. Das, G.B.V.C., Assistant Director, Civil Veterinary Department, Bihar and Orissa.	Ditto

LIST OF AGRICULTURAL PUBLICATIONS—*contd.*

No.	Title	Author	Where published
<i>Veterinary—contd.</i>			
90	Annual Report of the Punjab Veterinary College, Civil Veterinary Department, Punjab, and the Government Cattle Farm, Hissar, for 1921-22. Price As. 11.	Issued by the Department of Agriculture, Punjab.	Government Printing Punjab, Lahore.
91	Annual Report of the Camel Specialist, Punjab, for 1921-22. Price As. 3.	Ditto	Ditto
92	List of Horse Shows and Cattle Fairs in the Punjab and Native States for 1922-23.	Ditto	Ditto
93	Prospectus of the Punjab Veterinary College, Lahore, 1923.	Ditto	Ditto
94	Surra Transmission Experiments. Punjab Veterinary Bulletin No. 5 of 1921.	H. E. Cross, I.C.V.D., Camel Specialist, Punjab and P. G. Patel.	Ditto
95	Transmission of Surra by <i>Tabanus nemocallosus</i> . Punjab Veterinary Bulletin No. 7 of 1921.	Ditto	Ditto
96	Camel Surra. Punjab Veterinary Bulletin No. 8 of 1922.	Ditto	Ditto
97	Argasidæ found in the Punjab. Punjab Veterinary Bulletin No. 9 of 1922.	Ditto	Ditto
98	Caponing of Fowls (Vernacular). Punjab Veterinary Bulletin No. 10 of 1922.	Abdullah Khan, Veterinary Assistant under Camel Specialist, Punjab.	Ditto
99	Treatment of Surra by Tartar Emetic (Vernacular). Punjab Veterinary Bulletin No. 11 of 1922.	Ditto	Ditto
100	Annual Administration Reports of the Bombay Veterinary College, Glanders and Farcy Department and the Civil Veterinary Department, Bombay Presidency (including Sind), for the year 1921-22.	Issued by the Civil Veterinary Department, Bombay.	Government Central Press, Bombay.
101	Annual Administration Report of the Civil Veterinary Department, Madras Presidency, for 1921-22. Price As. 3.	Issued by the Civil Veterinary Department, Madras.	Government Press, Madras.
102	Anthrax. Madras Civil Veterinary Department Leaflet No. 6.	Ditto	Ditto

LIST OF AGRICULTURAL PUBLICATIONS—*concl.*

No.	Title	Author	Where published
<i>Veterinary—concl.</i>			
103	Report on the Working of the Civil Veterinary Department of the Central Provinces and Berar during the year 1921-22. Price R. 1.	Issued by the Civil Veterinary Department, Central Provinces and Berar.	Government Press, Nagpur.
104	Report of the Civil Veterinary Department, Assam, for the year 1921-22. Price As. 8.	Issued by the Department of Agriculture, Assam.	Assam Secretariat Printing Office, Shillong.
105	Report of the Civil Veterinary Department (including the Insein Veterinary School), Burma, for the year ending 31st March, 1922.	Issued by the Civil Veterinary Department, Burma.	Government Printing, Burma, Rangoon.

PUBLICATIONS OF THE IMPERIAL DEPARTMENT OF AGRICULTURE IN INDIA

TO BE HAD FROM

THE OFFICE OF THE AGRICULTURAL ADVISER TO THE GOVERNMENT OF INDIA, PUSA, BIHAR,
and from the following Agents :—

- | | |
|---|--|
| (1) THACKER, SPINK & CO., CALCUTTA. | (7) THACKER & CO., LTD., BOMBAY. |
| (2) W. NEWMAN & CO., CALCUTTA. | (8) SUNDER PANDURANG, BOMBAY |
| (3) RAI M. C. SARKAR BAHADUR &
SONS, CALCUTTA. | (9) RAI SAHIB M. GULAB SINGH &
SONS, LAHORE. |
| (4) HIGGINBOTHAMS, LTD., MADRAS. | (10) MANAGER, EDUCATIONAL BOOK
DEPÔT, NAGPUR. |
| (5) THOMPSON & CO., MADRAS. | |
| (6) D. B. TARAPOREVALA, SONS &
CO., BOMBAY. | |

A complete list of the publications of the Imperial Department of Agriculture in India can be obtained on application from the Agricultural Adviser to the Government of India, Pusa, Bihar, or from any of the above-mentioned Agents.

These publications are :—

1. The *Agricultural Journal of India*. A Journal dealing with subjects connected with agricultural economics, field and garden crops, economic plants and fruits, soils, manures, methods of cultivation, irrigation, climatic conditions, insect pests, fungus diseases, co-operative credit, agricultural cattle, farm implements, and other agricultural matters in India. Illustrations, including coloured plates, form a prominent feature of the Journal. It is edited by the Agricultural Adviser to the Government of India, and is issued once every two months or six times a year. *Annual Subscription*, Rs. 6 or 9s. 6d., including postage. Single copy, R. 1-8 or 2s.
2. Scientific Reports of the Agricultural Research Institute, Pusa.
3. Annual Review of Agricultural Operations in India.
4. Proceedings of the Board of Agriculture in India.
5. Proceedings of Sectional Meetings of the Board of Agriculture.
6. Memoirs of the Imperial Department of Agriculture in India :
 - (a) Botanical Series.
 - (b) Chemical Series.
 - (c) Entomological Series.
 - (d) Bacteriological Series.
 - (e) Veterinary Series.
7. Bulletins issued by the Agricultural Research Institute, Pusa.
8. Indigo Publications.
9. Books.

The following are the publications of the last two years :—

Scientific Reports of the Agricultural Research Institute, Pusa (including the Reports of the Imperial Dairy Expert and Secretary, Sugar Bureau), for the year 1920-21. Price, R. 1-8.

Scientific Reports of the Agricultural Research Institute, Pusa (including the Reports of the Imperial Dairy Expert and Secretary, Sugar Bureau), for the year 1921-22. Price, As. 14.

VOL. XVIII, PART IV.

July, 1923

THE AGRICULTURAL JOURNAL OF INDIA



EDITED BY

The Agricultural Adviser to the Government of India

PUBLISHED FOR

THE IMPERIAL DEPARTMENT OF AGRICULTURE IN INDIA

BY

THACKER, SPINK & CO., CALCUTTA

W. THACKER & CO., 2, CREED LANE, LONDON

Price R. 1-8 or Two Shillings

Agents for the Sale of Government Publications

IN EUROPE

- Constable & Co., 10, Orange Street, Leicester Square, London, W.C.
Kegan Paul, Trench Trübner & Co., 69-74, Carter Lane, E.C., and 25, Museum Street, London, W.C.
Bernard Quaritch, 11, Grafton Street, New Bond Street, London, W.
P. S. King & Sons, 2 & 4, Great Smith Street, Westminster, London, S.W.
H. S. King & Co., 65, Cornhill, E.C., and 9, Pall Mall, London, W.
Grindlay & Co., 54, Parliament Street, London, S.W.
Luzac & Co., 46, Great Russell Street, London, W.C.
W. Thacker & Co., 2, Creed Lane, London, E.C.
T. Fisher Unwin, Limited, 1, Adelphi Terrace, London, W.C.
B. H. Blackwell, 50 & 51, Broad Street, Oxford.
Deighton, Bell & Co., Ltd., Cambridge.
Oliver & Boyd, Tweeddale Court, Edinburgh.
E. Ponsonby, Ltd., 116, Grafton Street, Dublin.
Ernest Leroux, 28, Rue Bonaparte, Paris.
Martinus Nijhoff, The Hague, Holland.
Otto Harrassowitz, Leipzig.
Friedlander and Sohn, Berlin.

IN INDIA AND CEYLON

- Thacker, Spink & Co., Calcutta and Simla.
W. Newman & Co., Calcutta.
R. Cambay & Co., Calcutta.
S. K. Lahiri & Co., Calcutta.
B. Bannerjee & Co., Calcutta.
The Indian School Supply, Depot, 309, Bow Bazar Street, Calcutta, and 226, Nawabpur, Dacca.
Butterworth & Co. (India), Ltd., Calcutta.
Rai M. C. Sarkar Bahadur & Sons, 75-1-1, Harrison Road, Calcutta.
The Weldon Library, 57, Park Street, Calcutta.
Standard Literature Co., Ltd., Calcutta.
Lal Chand & Sons, Calcutta.
Higginbothams, Ltd., Madras.
V. Kaliyannarama Iyer & Co., Madras.
G. A. Natesan & Co., Madras.
S. Murthy & Co., Madras.
Thompson & Co., Madras.
Temple & Co., Madras.
P. R. Rama Iyer & Co., Madras.
E. M. Gopalakrishnan, Madras.
Thacker & Co., Madras.
A. J. Combridge, Madras.
D. B. Tarapore, Madras.
Mrs. Radhabai, Madras.
Sunder Pandurang, Bombay.
Gopal Narayan & Co., Bombay.
Ranchandra Govind & Son, Kalbadevi, Bombay.
A. H. Wheeler & Co., Allahabad, Calcutta and Bombay.
N. B. Mathur, Superintendent, Nazir Kanun-i-Hind Press, Allahabad.
Rai Sahib M. Gulab Singh & Sons, Mufid-i-Am Press, Lahore.
A. Chand & Co., Lahore, Punjab.
Ram Krishna & Sons, Lahore.
Superintendent, American Baptist Mission Press, Rangoon.
Manager, the "Hitavada," Nagpur.
S. C. Talukdar, Proprietor, Students & Co., Cooch Behar.
A. M. & J. Ferguson, Colombo, Ceylon.
Manager, Educational Book Depôts, Nagpur and Jubbulpore.*
Manager of the Imperial Book Depot, 63, Chandney Chawk Street, Delhi.*
Manager, "The Agra Medical Hall and Co-operative Association, Ltd." (Successors to A. John & Co., Agra.)*
Superintendent, Basel Mission Book and Tract Depository, Mangalore.*
P. Varadaachary & Co., Madras.*
H. Liddell, Printer, etc., 7, South Road, Allahabad.*
D. C. Anand & Sons, Peshawar.*
Ram Dayal Agarwala, 184, Katra, Allahabad.*
Manager, Newal Kishore Press, Lucknow.*

* Agents for the sale of Legislative Department Publications only.

CONTENTS

(VOL. XVIII, PART IV)

ORIGINAL ARTICLES

	PAGE
SOME COMMON INDIAN BIRDS. NO. 22. THE INDIAN HOUSE-CROW (<i>Corvus splendens</i>) ..	323
T. Bainbrigg Fletcher, R.N., F.L.S., F.E.S., F.Z.S.; and C. M. Inglis, M.B.O.U., F.E.S., F.Z.S. ..	
THE CATTLE PROBLEM OF THE UNITED PRO- VINCES	330
H. M. Leake, M.A., Sc.D., F.L.S., M.L.C. ..	
RECENT SOIL RESEARCHES AND THEIR APPLICA- TION TO PRACTICAL AGRICULTURE ..	349
N. Kunjan Pillai, Ph.D., M.A., B.Sc.	
<i>Cholam</i> (<i>Andropogon Sorghum</i>) AS A SUBSTITUTE FOR BARLEY IN MALTING OPERATIONS ..	362
Roland V. Norris, M.Sc., F.I.C., D.Sc.; and B. Viswanath ..	
TECHNOLOGICAL RESEARCH ON RAW MATERIALS AND ITS RELATION TO PLANT BREEDING ..	374
B. C. Burt, M.B.E., B.Sc. ..	
THE SECOND VETERINARY CONFERENCE, CALCUTTA	380

SELECTED ARTICLE

GETTING ALONG WITH THE BOLL-WEEVIL	403
--	-----

NOTES

NOTE ON SOME SUGARCANE JUICES RECEIVED FROM RANCHI FARM ..	410
AN IMPROVED FORM OF KJELDAHL APPARATUS	415

	PAGE
SPINELESS OPUNTIA IN WESTERN INDIA	417
SECOND SALE OF SAHIWAL BULLS OF THE MILITARY DAIRY FARMS ..	420
TRIALS WITH TURNIPS, SWEDES AND MANGOLD	422
RHINOCEROS BEETLE	423
REPORT OF THE WATER-HYACINTH COMMITTEE, BENGAL	424
COTTON GROWING IN BRAZIL	426
COTTON RESEARCH	435
PERSONAL NOTES, APPOINTMENTS AND TRANSFERS, MEETINGS AND CONFERENCES, ETC.	441
REVIEWS	
THE CO-OPERATIVE MOVEMENT IN INDIA	445
HAPPY INDIA, AS IT MIGHT BE IF GUIDED BY MODERN SCIENCE ..	447
THE COMMON BIRDS OF INDIA	448
NEW BOOKS ON AGRICULTURE AND ALLIED SUBJECTS ..	449

LIST OF ILLUSTRATIONS.

The Indian House-Crow (<i>Corvus splendens</i>)	Frontispiece
	Facing page
Plate XII. Second Veterinary Conference, Calcutta ..	. 380
„ XIII. Sahiwal Cattle of the Military Dairy Farms 422
„ XIV. A Collection of Webb's Beef Heart Turnips 423
„ XV. Mr. E. Ballard 441

**The following Original Articles will appear in our next issue
(September 1923).**

- SOME COMMON INDIAN BIRDS. NO. 23. THE
 JUNGLE CROW (*Corvus coronoides levaillanti*).. *T. Bainbrigge Fletcher,*
R.N., F.L.S., F.E.S.,
F.Z.S. ; and C. M. Inglis,
M.B.O.U., F.E.S., F.Z.S.
- DIGESTION EXPERIMENTS WITH PADDY STRAW .. *F. J. Warth, M.Sc., B.Sc.*
- INBREEDING IN COTTON AND ITS IMPORTANCE
 TO THE PLANT BREEDER *S. C. Harland, D.Sc., F.L.S.*
- PROGRESS OF POULTRY INDUSTRY IN THE
 UNITED PROVINCES *Mrs. A. K. Fawkes.*
- THE MOSAIC DISEASE OF SUGARCANE IN INDIA .. *Jehangir Fardunji Dastur,*
M.Sc.
- THE RELATIONSHIP OF THE SPECIES OF FUSARIUM
 CAUSING WILT AND DRY ROT OF POTATOES IN
 WESTERN INDIA *S. L. Ajrekar, B.A., and*
M. N. Kamat, B.Ag.
- THE INFLUENCE OF NOTCHING ON THE YIELD
 OF THE FIG TREES *G. S. Cheema, M.Sc., and*
S. R. Gandhi, B.Ag.
- PROBABLE ERROR IN VARIETY TRIALS WITH
 PADDY *B. N. Sarkar, L.Ag.*
- THE OPERATIONS AGAINST THE BUD ROT OF
 PALMYRA PALMS ON THE EAST COAST .. *W. McRae, M.A., B.Sc.*



THE INDIAN HOUSE-CROW (*CORYVUS SPLENDENS*)

Original Articles

SOME COMMON INDIAN BIRDS.

No. 22. THE INDIAN HOUSE-CROW (*CORVUS SPLENDENS*).

BY

T. BAINBRIGGE FLETCHER, R.N., F.L.S., F.E.S., F.Z.S.

Imperial Entomologist ;

AND

C. M. INGLIS, M.B.O.U., F.E.S., F.Z.S.

OF the Mynah, the subject of our last paper, it was said that it needed little introduction, but the subject of our present paper needs none at all, as it positively thrusts itself into notice and, especially in towns, is the most familiar (in the literal sense of this word) of all Indian wild birds. From early dawn to dewy eve the House-crow is with us, resting somewhere handy to swoop down on any edible morsel and making day hideous with its raucous voice as it relates its misdeeds, which are as black as itself. One feels tempted to stop here and leave our Plate to speak for itself. Is not the House-crow at hand to speak for himself? *Si exemplum requiris, circumspice.* And has he not been treated of at considerable length by many able writers on Indian Birds—Lockwood Kipling, Finn, Cunningham, Aitken, Dewar, Stuart Baker and others? Dewar has even devoted a whole volume to “The Indian Crow his Book,” which is a signal mark of esteem, as few wild Indian animals have been so honoured—indeed, I can only think at the moment of two others, the tiger, on whose life-story Eardley Wilmot wrote a book, and the sperm-whale, whose doings are chronicled in Melville’s

Moby Dick and Bullen's *Cruise of the Cachalot*. It seems therefore rather a work of supererogation to add to the literature on this bird nor is it possible to compress into a short article the mass of material available.

The House-crow needs little description, being deep glossy-black except for the nape, ear-coverts, the whole head, upper back and breast, which are light ash-brown. The black portions of the plumage are highly resplendent, when seen at a proper angle, with purple-blue and greenish reflections, whence apparently the specific name *splendens*. The contrast between the paler and darker portions of the plumage varies considerably according to locality and this crow has been divided into subspecies on this character, the Sind House-crow (*Corvus splendens zugmayeri*), found in the extreme North-West of India, having the paler parts almost white in sharp contrast to the black, the Burmese House-crow (*Corvus splendens insolens*) found in Southern Burma, having the dark parts shading into the lighter, which are ill-defined and of a blackish-grey, and the Ceylon House-crow (*Corvus splendens protegatus*), confined to Ceylon, having the light parts shading into the darker but easy to define, whilst the typical race (*Corvus splendens splendens*), shown on our Plate and found throughout the remaining portions of the Indian Empire, has the difference between the grey and black portions of the plumage well-defined. These races, however, tend to run into one another so that individuals from the south of Travancore, for example, are much darker than Northern Indian birds and show a distinct approach to the subspecies found in Ceylon.

The House-crow has little use for a rural life and is scarcely ever seen in the jungle, but any collection of human habitations is sure to have its quota of corvine vagabonds, and, the larger the town, the greater the number of crows. Dewar states that "probably over a million crows dwell in Calcutta" and such a number certainly does not seem exaggerated. About eleven years ago a terrific hail-storm in Calcutta killed them off in tens of thousands, so that the *maidan* was littered with crow corpses, but nowadays the Calcutta crow population seems to be larger than ever. Probably much the same might be said of all large Indian towns. As Aitken puts it,

“ The crow is a fungus of city life, a corollary to man and sin. It flourishes in the atmosphere of great municipalities, and is not wanting in the odorous precincts of the obscure village innocent of all conservancy.” Kodaikanal is the only town known to me where crows are not. In large towns, where natural enemies are few and food plentiful, the crow has an easy life, increases in numbers and waxes impudent, but in the *mofussil* he has a rather harder time and wears a more subdued look. At Pusa, for example, there are always a few of these crows hanging around the bungalow but they hardly ever make a nuisance of themselves as they do in towns.

The House-crow makes an easy living by its almost omnivorous habits. In the neighbourhood of houses, it is essentially a garbage-eater and a picker-up of unconsidered trifles in the way of scraps of human food, cooked or uncooked, and preferably acquired by theft. For the crow is not only an outcast scavenger but a thief, delighting to steal from man or dog or other animal or even from its own fellows. Grain, whether in bags in a railway truck or exposed for sale in a shop or in the field, is always an attraction for crows. Fruits, especially figs and mulberries, are eaten greedily and the young and eggs of other birds form especial delicacies, varied by an occasional debauch on carrion. With regard to insect food, crows do not seem to have such a varied diet as one would expect and insects are usually only eaten in any numbers when they occur in swarms ; on such occasions, termites, locusts and caterpillars may be eaten to a considerable extent. So that when they eat injurious insects, it is only at a time when the damage caused by these insects has been done and when their destruction even on a large scale makes comparatively little difference to their numbers. Under such conditions an attack on insects by birds is to all intents and purposes useless and of very small value as compared with the good done by an habitually insectivorous bird which feeds on insects throughout the year and which is therefore constantly acting as a check on the increase to undue proportions of its insect prey. A crow only helps to lessen to a small extent the undue proportion of any one species of insect when he notices that they are in swarms and he feels inclined to eat or worry them. For this reason, it is

impossible to regard the crow as beneficial from an agricultural view, especially in view of the damage done to grain and fruits. At the best, this bird can only be reckoned as of neutral value. In towns, where the conditions are sufficiently insanitary, it may be considered of some slight value as a scavenger but even against this must be set the annoyance caused by its thievish propensities and noisy habits.

The crow, however, has his good points. His intelligence is distinctly above the bird average and, even when he is making himself a nuisance around houses, a great deal of harmless amusement can often be obtained by watching his wily ways. To vary the poet slightly, very brief observation of his doings soon shows :—

“ That for ways that are dark,
And for tricks that are vain,
The House-crow is highly peculiar,
Which the same I am free to maintain.”

A liking for mischief for its own sake seems part of a crow's nature and this may be expressed by pulling up garden plants or digging up newly-sown seeds, or even by picking off flowers, or carrying off brightly-coloured objects, or very frequently by taking a delight in worrying other birds and animals for no apparent reason whatever. Robbery is usually at the bottom of this, as when crows worry such animals as kites or dogs, but pure mischief often seems concerned rather than a desire for food. An owl abroad in the daytime is always fair game for crows and a snake which ventures into the open is also often mobbed by crows and other birds such as drongos and mynahs. Lizards, such as *Calotes*, are often worried by crows and in his *Tribes on my Frontier* Aitken gives an amusing account of an occurrence of this nature, but a lizard or frog may sometimes be worried to death and then left uneaten, showing that the attack on it is not prompted by hunger. The crow's intelligence is also shown by the occasional holding of *panchayats*, when all the crows of the neighbourhood gather together and vociferously discuss some point of common interest, sometimes apparently the uncorvine conduct of one individual crow who is thereafter set upon by the rest and pecked to death or outcasted. Usually a

crow which is damaged in any way is worried to death by its fellows. Yet the crow will certainly rescue a friend in distress if he can and will not hesitate to show his indignation against the cause of suffering to his own comrades. The crow is also a good husband and a tender parent, devoted to his repulsive nestlings, in whose defence he will not hesitate to attack even man at times.

The House-crow nests at the beginning of the hot weather. In Calcutta building commences about February, but in some parts of Bengal it may even commence in December. The breeding season varies considerably according to locality. Generally speaking, March to May are the favourite months, later in the North and earlier in the South. The nest is a large and untidy mass of sticks, lined with smaller twigs or grass or almost any other softer material, and placed in the fork of a branch of any convenient tree near human habitations. If available, curious materials may sometimes be used for building. Several cases have been recorded in which crows' nests have been built of short lengths of wire and in Bombay one pair of crows constructed a nest of gold and silver spectacle frames of an estimated value of four hundred rupees. Another nest in Madras was made of bits of tin snippings taken from the Tin Bazaar. Both the parent birds collect the material for the nest but its actual construction is apparently the sole duty of the female, the male transferring to his partner, for fixing in the nest, the material which he brings in in his beak. The twigs used may be collected off the ground, or, if not thus available, be broken off growing branches. When building is going on, the male bird accompanies the female everywhere and will not let her go out of his sight. The labour of collecting and building is varied by brief intervals of connubial affection which takes the form of head tickling, but this is not allowed to delay the completion of the nest, which is usually finished in about two days. Thereafter the hen lays in it four or five (sometimes two or three or six, or rarely seven) eggs, which measure about 37 by 27 mm. and vary greatly in colour, the ground being any shade of blue-green, blotched with dull reddish, and brown, with small secondary markings, of grey or

neutral tint, irregular in shape and scattered profusely over the whole surface of the egg.

At this stage, the crow is often parasitized by the koel (*Eudynamis scolopaceus*), the male of which is a black bird with a very long tail and looking like a drongo, whilst the female koel is glossy black-brown, spotted and barred with white. Both combine to achieve their end of depositing an egg in the crows' nest, and they do this in a very interesting way. Crows seem to hate the sight of the koel, which takes advantage of this fact. The male koel flies up to the crows' nest and attracts the crows to chase him away, a pursuit in which he is quite safe as he is faster on the wing, the koel taking care to lead the crows after him as far as possible. Meanwhile, as soon as the coast is clear, the female koel slips into the deserted nest and deposits an egg, after which she flies off again with a triumphant cry of "*Kuil, Kuil, Kuil,*" as a signal that the deed has been done, whereupon the male koel shakes off his pursuers and leaves them to return to their nest. Whether the female koel destroys any of the crows' eggs before depositing her own is not certain but this is probably the case. In any case, the crows do not detect the difference, as they seem to be incapable of counting. Whether the female koel actually lays the egg in the nest is also uncertain, but it is more probable that she lays it elsewhere and then transports it in her mouth until she obtains access to the nest.

Apparently the crows are so pleased with themselves at the successful hatching of the eggs that they are indifferent to the nature of their strange nestlings. At any rate, they appear to be fond of their foster-children. Aitken relates that on one occasion he saw "a pair of crows feeding a clamorous young koel, together with its foster-brother, their own child. It was hungry and clamorous too, but the koel appeared to be the favourite with the parents." The newly-hatched crow nestling is such an abominably ugly little brute that perhaps it is excusable to suppose that even its own parents may prefer a young koel. Be this as it may, they certainly watch over their young with assiduous care and the nest is never left unguarded for a moment, each parent taking its turn to go out and forage.

As Dewar puts it:—"The reason for its devotion is not far to seek. It is the penalty of wickedness. It is a case of thieves knowing the ways of thieves. Crows are notorious robbers of nests; neither eggs nor young birds come amiss to them. They know the evil that is in the corvine heart; hence the careful guarding of the young." But even the watchfulness of the parent birds is unavailing to keep away the fly (*Passeromjia heterochæta*) which commonly lays its eggs in crows' nests and whose grubs suck the blood of the young nestlings.

The House-crow needs no protection but is quite capable of looking after itself. Hence it receives no benefit in any Province under the Wild Birds' Protection Act, and in most large towns in India it will doubtless be considered that his numbers might be reduced with advantage. Yet other countries have endeavoured at times to acquire him by compulsory immigration. Thus, Finn states that "he has of late years been introduced as a scavenger into Zanzibar," and in December 1902 a consignment of House-crows was sent from Ceylon* to the Malay Peninsula to help in reducing an outbreak of caterpillars on Coffee in the Straits.

The habits of this bird would fill a book and we have only space to refer to its gregarious habit of roosting by night in favourite trees during the non-breeding season. Sometimes, the trees selected as a dormitory serve the same purpose during the daytime for flying foxes. Thus, on the west coast of Ceylon, about thirty-five miles South of Colombo, lies the small island of Barberyln, covered with coco palms, whose tops provide a resting place for these large bats in the daytime and for crows at night, and in the early morning and evening may be seen the passage across the strait dividing the island from the mainland of immense flocks of crows and flying foxes, the one starting out to forage and the other intent on rest.

The House-crow must not be confused with its near relative, the Jungle Crow, "of whom next," as the genealogists have it.

* See *Spolia Zeylanica*, Vol. I, pp. 23-33, Fig. 13 (1904).

THE CATTLE PROBLEM OF THE UNITED PROVINCES.

BY

H. M. LEAKE, M.A., Sc.D., F.L.S., M.L.C.,
Director of Agriculture, United Provinces.

FOREWORD.

THAT all is not well with the cattle of the United Provinces is too obvious a fact to require demonstration. The fact is so well known that many individuals and more than one association are turning their attention to the problem. That the seriousness of the situation is recognized is all to the good but, like most problems, which are largely economic, it is by no means simple and it is unfortunate that those bodies which have devoted their energies to its solution have, in large measure, failed to recognize its complexity. Consequently measures have been advocated which cannot, if adopted, afford relief and may even produce harm.

Fundamentally it is an economic problem, but there is also a strong current of sentiment which cannot be overlooked. In such cases it is best frankly to recognize the two forces at work even where they are opposed. The strength of a country depends on its material wealth and this can only be built up on sound economic principles. Where sentiment intervenes as an opposing force a condition arises where a choice may have to be made between material prosperity and that sentiment. The choice must lie with the people and it can only be accounted to their credit if they choose in favour of the latter. But the choice should be made with open eyes and nothing is to be gained by confusing the two issues.

It is because much of the recent literature on the subject indicates the existence of such a confusion of ideas that I have ventured on the following note. In it I have attempted to lay

bare the economic aspect ; to show how far this is opposed to the sentimental aspect, and to indicate the directions in which the two can in large measure be reconciled to achieve the object all desire.

The problem, being largely economic, is approached from that aspect. It is, perhaps, none the worse, therefore, for being handled by one who makes no profession to be an expert on cattle. I have, however, taken the precaution of checking the technical points raised and I am indebted to Mr. C. H. Parr, the Deputy Director of Agriculture, In charge of Cattle Breeding Operations, Muttra, for such check, advice and criticism.

INTRODUCTION.

The obvious facts of the cattle problem as it appears in the United Provinces are the diminution of numbers and the reduction of grazing grounds. From the very obviousness of these facts these two points have been seized on and placed in the forefront of a campaign, which advocates increased grazing grounds and larger numbers. Unfortunately the problem is not so simple ; the relation between cause and effect is not so direct and the recognition of which is cause and which is effect is not so simple that a removal of what appears the obvious cause will produce the desired effect. Both points are capable of practical remedy ; the rate of increase of cattle is such that a deficiency will soon be made up if the mortality is reduced and it is possible, if not desirable, to restrict encroachment on, and even to extend, grazing grounds by legislation. Here again, however, we find an apparently obvious cause and effect which will prove on investigation to be little more than apparent. One of the most obvious, because concentrated, sources of mortality is the slaughter-house—and, in consequence, an agitation has been conducted against such institutions. It will become apparent, however, that this source of mortality has not the importance, from the economic aspect, that the agitation attributes to it. We have, in fact, to penetrate more deeply into the underlying economic conditions if we are to obtain that insight into the causes which will alone dictate the remedy.

SOME FUNDAMENTAL CONSIDERATIONS.

The cattle problem will never be understood and the true remedy of the present unsatisfactory conditions will never be realized until certain fundamental conditions which underlie the whole problem are taken into account. The primary fact is this : cattle share, with all other living organisms, a common feature, namely, a rapid rate of increase. Were there no check to the cattle population, this would increase rapidly : in actual figures it would double in about 10 years and quadruple in about 20 years. The fact that the population is stationary or even suffering a decrease indicates that a check is applied which, in the absence of any common contraceptive practice, must be due to a high mortality.

THE NUMERICAL STRENGTH OF THE CATTLE POPULATION.

It has been customary, as a measure of the adequacy of cattle to a country, to refer to the number of head of cattle per 100 of population. In a recent public statement on the subject such a series was given from which, as India showed the lowest figure, it was argued that the position in India was precarious. The fallacy of this argument is shown by the following statement of cattle per 100 of population.

Japan	2
Belgium	17
United Kingdom	27
Germany	32
India	45
Denmark	74
United States of America	79
Canada	80
New Zealand	150
Australia	259

Assuming the argument correct, the position of Germany, of the United Kingdom and still more of Belgium and Japan, must be precarious in the extreme. That this is so can not be accepted and we have to trace out the fallacy in the argument. That fallacy is found in the divergent uses to which cattle are put in the different countries. In the United Kingdom the male is only retained for

service, relatively few are kept and the remainder are used for food as soon as sufficiently grown. On the other hand agricultural operations are carried out by horses and there is also a large import of dairy produce indicating that, in this respect, the United Kingdom is not self-supporting. Denmark, again, is an exporter of dairy produce indicating an excess of cows for the head of population. New Zealand and Australia are ranching countries in which large herds are kept mainly for the export, meat and dairy produce, markets. These facts are sufficient to show that any comparison of this nature is fallacious and that each country has what may be called a normal cattle population dependent on the uses to which the cattle are put. A just comparison can, in fact, only be drawn in cases where the cattle are put to similar uses.

THE USES OF CATTLE IN THE UNITED PROVINCES.

The uses to which cattle are put in the United Provinces are two-fold : the bullock is the main source of agricultural and draught power, while the cow is the source of milk and milk products. The cattle population which will fulfil the requirements of the province is that which will provide the requirements on these two heads.

THE NUMBER OF HEAD OF CATTLE IN THE UNITED PROVINCES.

While the desirable cattle population is summed up in the above generalization, it is not an easy matter to reduce this to exact numbers. The following comparative table, drawn from the latest statistics, is, however, indicative :—

		<i>United Provinces</i>	<i>Punjab</i>
Cattle per 100 of population	64·0	57·0
Cows and cow buffaloes per 100 of population	21·7	24·6
Area cultivated per 100 bullocks	388·0	665·0

If these figures have any meaning, it is that the cattle population of the United Provinces is excessive and that the lower population of cows is more than counterbalanced by the excess of bullocks. This opens up a further field of enquiry relative to numbers. The

essential fact with regard to the bullock is that there is a certain fairly definite amount of work to be done. That work can be done by a certain number of animals or it may be done by half that number. This difference is expressed by saying that in the latter case the cattle are twice as efficient. The true position, then, is this : that actual numbers are of relatively insignificant importance ; the really important question is the efficiency. Generally speaking, the above facts indicate an inferiority of United Provinces bullocks relative to those of the Punjab. We can however go further than this. If the standard of the bullock has not been raised to one of marked efficiency, we might reasonably expect to find a like lack of efficiency in the cow. This expectation is in accordance with the facts. The United Provinces breeds are not among the milking breeds of India. Their yield is at the best below that of such milking breeds as the Montgomery and Sindhi and far below that of such breeds as the Short-horn and the Friesian of England and Europe as the following statement will show :—

Average yield per annum of milk of average cows of different breeds in lb.

		lb.
United Provinces Breeds	{ Mewati or Kosi ..	2,000
	{ Kherigarh ..	500
United Provinces Buffaloes ..	2,500
Punjab Breeds ..	{ Hansi ..	2,500
	{ Montgomery ..	2,500
	{ Sindhi ..	2,500
Delhi Buffaloes ..	4,000
Average English Cattle	.. Short-horn and Friesian	7,200

THE CONSEQUENCES OF RECOGNITION OF THE IMPORTANCE
OF EFFICIENCY.

The recognition of the importance of efficiency leads to certain inevitable conclusions. These are perhaps best understood to follow from a consideration of the mechanical aspect of cattle.

Cattle, in their mechanical aspect, may be compared to an engine* : for the supply of a certain amount of fuel, here represented by food, a certain amount of work is performed or a certain amount of produce, in the form of milk, is obtained. Just as engines differ in efficiency, that is, give differing amounts of work for the same amount of fuel supplied, so it is with cattle. As economy dictates the choice of that engine which will do the work required, so should it dictate the choice of that animal which will do that work which is required of it, with the minimum amount of food. There are two means of arriving at this position, one of which is as undoubtedly right as the other is wrong. By the first, and correct, method the animal will be selected with regard to the work required and its potential capacity when kept in good condition ; by the second, and wrong, method the animal is not so selected, but is merely supplied with that minimum amount of food which will produce the required work. To continue the mechanical comparison, we can compare the first method to selecting an engine which develops most efficiently 5 h.p. for work requiring 5 h.p. and the second to selecting a 10 h.p. engine for the same work and running it inefficiently to develop 5 h.p. In the case of the animal, however, there is a defect which does not occur in the engine. The 10 h.p. engine will recover its full capacity when the fuel supply is increased, the animal will not. Reduction in food will, sooner or later, lead to a permanent debility which cannot be made good and which may be, and often is, passed on to the next generation. We are thus led to a consideration of the fodder supply with which is prominently associated the question of grazing grounds.

FODDER SUPPLY AND GRAZING GROUNDS.

At the commencement of this note attention was drawn to the emphasis that has been laid upon the obvious restrictions of so called grazing grounds. The extent of these areas, for which the official designation of "culturable wastes" is, perhaps, more appropriate,

* This aspect of cattle is discussed in my Book on the Bases of Agricultural Practice and Economics in the United Provinces.

and their relation to the number of cattle is indicated in the following table :—

				No. Head per 100 acres
Total Province (excluding hills)	206
District	Goarakhpur	421
	Aligarh	395
	Jaunpur	373
	Gonda	367
	Meerut	358
	Partabgarh	353
	Ghazipur	298
	Rae Bareli	267
	Cawnpore	253
	Muzaffarnagar	239
	Shahjahanpur	201
	Kheri	174
	Banda	135
	Mirzapur	105
	Jhansi	60
Jhansi Division	79

Compare, in the first place, these figures with the English figure of 4 head to 3 acres or 1·33 head per acre ; compare also the yield of fodder, both hay and grazing, raised from an acre in the two cases. To obtain the same density of cattle the “ grazing grounds ” of the province must be multiplied by 1·55 and to obtain the same fodder supply as is produced by an English meadow land this figure must be still further multiplied by 2·0. Such an increase of grazing grounds is clearly out of the question ; it can only be effected at the expense of cultivated land on which the people’s food is grown. The problem is not to be solved in this direction.

We may look at the question of grazing grounds a little more closely. Recent tendency has been to replace grazing grounds by cultivation. But there are two forms of cultivation—the first of which provides food and produce used by man, while the other produces food for cattle. At the moderate estimate, average land will, when cultivated, produce 10–15 times the weight of fodder produced when it is uncultivated. That is the reward for the labour of cultivation but, unfortunately, with the same, or but little more, labour of cultivation, it is possible to reap a still greater reward

from non-fodder crops and, consequently the tendency is, when replacement takes place, to replace the grazing grounds less by fodder crops than by more profitable crops. Here is the real crux of the problem. Far from the restriction of grazing grounds being injurious, as is generally assumed, such restriction is all to the good inasmuch as those lands, capable of producing crops, are more profitable under cultivation than as wastes; what is desirable is, by an organization of the rotations and such means, to introduce a larger percentage of fodder crops. This is an economic question which brings us back to the problem of efficiency.

THE DEFINITION OF EFFICIENCY.

The problem has now been narrowed down to the economic one of levelling up the return of a unit area of fodder to that of the same area of other crops at present more valuable—and it must be understood that reference here is not made to value expressed in cash. Broadly speaking, this fodder takes the place of fuel to an engine; and it is only possible to attain that increased value of the fodder crop if it is fed to the most efficient animal. It is imperatively necessary, therefore, to raise the efficiency of the cattle of the country to the maximum. It must be confessed that the economic balance between fodder and other crops, has, in recent years, been so adverse to the cultivation of fodder that the cattle of the province have become far from efficient. It is necessary therefore to define efficiency a little more carefully. Of the young stock produced half are males and half females; of the former a few are allowed to develop as bulls for the purpose of service but the vast majority are castrated and used for draught purposes. The main use of the cow may be to supply milk or it may be to supply young working cattle. It is a question of breed, for the two sexes cannot be raised independently and clearly the most efficient breed will be that which supplies, relative to the food consumed, on the male side the best working bullock and, on the female side, the best milking cow. Unfortunately such a combination is not attainable and the perfect dual purpose breed does not exist. The choice has to be made between a breed furnishing efficient working bullocks, a breed

furnishing efficient milkers and a dual purpose breed supplying both moderately efficient working cattle and moderately efficient milkers. Which will be most profitable will depend largely on the economic circumstances, in their turn a matter of locality.

THE GENERAL PROBLEM DEFINED.

Broadly speaking, then, we are enclosed in a vicious circle. The food supply is deficient for the number of cattle raised; this number of cattle are required because the individual is inefficient and the inefficiency is the result of an insufficient fodder supply. It is this vicious circle which has to be broken before any remedy can become effective and it is the breaking of this circle which constitutes the real problem. The problem is, thus, fundamentally, economic and, as is usual in such cases, by no means easy of solution. It will certainly not be solved by the remedy so insistently proclaimed, the development of grazing grounds, still less will it be solved by the so often demanded increase in the numbers of cattle.

The solution, if it is to be found at all, will be found in an increase of efficiency in the individual. Such an increase will enable better cultivation to be practised and will lead to greater production from the land in the case of working cattle and a greater return in milk in the case of milking cows. The increased efficiency will only be maintained if stimulated by better feeding which the owner will be enabled to give in the case of bullocks out of his increased crop returns, the reward of better cultivation, and by greater monetary return from milk in the case of cows, as the extra cost of feeding necessary is small in proportion to the increased return derivable thereby from an efficient animal.

THE COMPLEXITY OF THE PROBLEM.

If we revert to the table given on page 336, the prominent feature of the figures given is the large differences that occur for different tracts of the province. There are in Gorakhpur nearly 4 times as many cattle per 100 acres of "grazing grounds" as there are in the Jhansi District. We might reasonably expect, therefore,

that, if extension of grazing grounds is the remedy for the disease, the cattle of Bundelkhand would be the best in the Province. This expectation is however directly opposed to fact. The best cattle are produced in the neighbourhood of Aligarh which, next to Gorakhpur, has the highest figure for cattle per 100 acres of grazing ground.

These figures are in themselves indicative of the complexity of the problem, but they are in all probability not the most striking that could be obtained. Were it possible to obtain a figure for the head of cattle per 100 acres grazing ground within a radius of say 5-6 miles of the larger cities, it is more than probable that these would indicate a still larger number of cattle per 100 acres of grazing ground than any quoted. Such figures are, unfortunately, not available, but there can be no doubt that the problem in, and in the environs of, the cities is totally distinct from that of the country-side. In the former, there is a large demand for milk and dairy products from a non-agricultural population, with consequent emphasis laid on the cow; while, in the latter, the main demand is for the working bullock, and the cow here figures mainly as the producer of young stock.

The above difference is such that we must treat the two problems separately. Minor variations in the problem, however, may be briefly indicated. In the east of the Province pressure of population has led to holdings of such size that little opportunity is afforded to grow any but the food crops required to meet the needs of that population. The reduction of open grazing lands and the inability to devote any but a mere fraction of the holding to fodder crops has resulted in an impoverishment of the cattle and a consequent increase of their numbers to make up for their inefficiency. In the west of the Province the unit of cultivation is larger and a larger proportion of the land is held by substantial cultivating zamindars. The advantage of efficient cattle is appreciated and growth of fodder crops is both possible and, to a certain extent, indulged in. The cattle are, consequently, of a superior type. In the Jhansi Division there is not the pressure of population found elsewhere in the Province and we have here the nearest approach to the ranching

conditions found in the sparsely populated parts of America, Australia, the Argentine, and so on. The poverty of the cattle is here due to the backwardness of the people resulting in lack of organization in disposing of dairy products, to the small margin of profit provided by the cattle breeding industry and also to the precarious climate with seasons of drought leading to intense fodder famines.

THE CITY PROBLEM.

Sufficient has, perhaps, been said to indicate the complexity of the problem and we may pass to a consideration of that aspect which concerns the cities. As has been noted above, in this aspect the milk supply bulks large. There is not the slightest doubt that the milk supply is both insufficient and bad. At the present time the milk supply of practically all large cities is in the hands of the *gwalas*. In the main these are cattle owners without land. They maintain their herds within the city precincts driving them to the nearest grazing grounds, not without, it must be confessed, considerable depredation to the fields through which the herds pass, or purchasing fodder for their maintenance. The insufficiency of fodder obtained under the first, and its expense under the second, method lead to the inevitable result that the cow is inefficient, milk expensive, the supply insufficient and the quality bad; for the temptation to adulterate is proportionate to the deficiency of the supply and to the cost.

A further result of this lack of system is the limitation of the herds to the milk-giving cow. The cow becomes a desirable possession under these conditions only so long as she yields milk; as soon as she becomes dry she is a burden to the owner. Hence arise such practices as the *phooka* process rendering the animal useless for further conception and, consequently, an uneconomic burden to be sold to the butcher or, where religious sentiment is sufficiently strong to prevent this, to remain a consumer of an already insufficient fodder supply.

THE SOLUTION OF THE CITY PROBLEM.

The above brief description of the conditions that obtain in the neighbourhood of the cities contains the salient features which point

the direction in which a remedy must be sought. The underlying economic force is the demand for milk, at the present time largely, and primarily, a demand for quantity and, secondarily only, for quality. The outward sign of that force is the high price of milk. It is not infrequently the case that milk will be selling at 3-4 seers in the city when a few miles outside it will fetch 8, 10 or even 12 seers only. The remedy for this condition is that which applies in all similar cases where large differences occur between the price of a commodity in different localities, namely, transport. The price of wheat differs but little in all parts of India and, in fact, all parts of the world and such differences as exist are determined by the cost of transport. The same remedy must be applied to the milk problem modified to meet the essential character of the commodity, namely, that it is perishable. Organization of transport will go far to relieve the situation and there is ample margin between the cost in the districts within transportable distance and the cost in the city to cover the cost of organized transport. It is an encouraging sign that this is beginning to be recognized and that the transport schemes which the Cattle Breeding Section of the Department have endeavoured to foster are proving a financial success.

THE RESULT OF ORGANIZATION OF TRANSPORT.

The advantage of such organization of transport is not limited to the obvious benefit resulting from an improved milk supply to the population. The indirect results are as important and far reaching. By this means a demand for milk is created throughout a considerable area which will replace *ghee* making by milk selling and thereby add greatly to the profits of cow keeping. Such a result can only result in the appreciation of the value of cattle in the affected area. This is, as we have seen, one of the essentials to improvement in the efficiency of cattle ; put in a few words, organization of transport will convert the cultivator into a cattle raiser. He will grow fodder to feed the stock he himself possesses, reaping his reward by the sale of milk. Instead of selling his fodder to the city *gwala* he will consume it himself and, further, since the transport of milk can be effected more readily over longer distances than can the

transport of fodder, the area affected will be enlarged and more fodder grown.

The success of the scheme depends on the enhancement of the fodder crop relative to the food crop, for, until the value of these two be brought to the same level it is hopeless to expect a change of habit in the methods of cultivation. Efficient organization of *cheap* transport is, therefore, essential, for such will enable the best price to be paid to the producer. There can be little doubt that the large prices realized for food grains in recent years as the result of the war have adversely affected the cattle position. With the recent fall in prices the value of food and fodder crops will more nearly approximate and the time appears opportune for development along these lines. The scheme recently laid before, and approved by, the United Provinces Cattle Committee is an effort to foster development in the above direction.

We may briefly consider yet a further advantage that will arise out of such an organization of the milk supply which converts the cultivator in the neighbourhood of the towns into a milk producer. As soon as that change is effected we will have created a body who will recognize the advantage of efficient milch cattle and it will be possible for Government or other agency to organise for service a supply of bulls carrying a known milk record ; we will have, in fact, the conditions which will admit of the effective use of such a supply of bulls. It has to be admitted that these conditions do not exist and that the present supply of bulls, though not without effect on the stock of the country, does not produce the material effect that it should.

THE RURAL PROBLEM AND ITS SOLUTION.

The intensity of the urban demand for milk affords a stimulus in the case of suburban areas which is lacking in rural areas. Further, as has been shown, above, the problem varies from tract to tract. It is not possible therefore to define as clearly the remedies which will be effective.

In time the organization of more and more perfect systems of transport should widen the area from which an increasing

population will have to draw its milk, but there must still remain tracts where this stimulus will be ineffective. For such tracts it will be necessary to search for such means as will increase the efficiency of cattle and these means may differ from tract to tract. In some cases it is possible that the production of the less perishable product, *ghee*, may be organized giving a subsidiary value to the cow. In others, again, emphasis will have to be laid on the efficiency of the bullock and reliance placed on the increased price of an efficient animal forcing recognition of the fact that it pays to grow fodder to maintain that efficiency.

THE CULT OF THE BULL.

The last proposition leads to a consideration of a further possible development. It is improbable that any tract can raise efficient cattle if the only demand is for the bullock. The proportion of the sexes is approximately equal and no development can be sound which leaves half the young stock unproductive unless that half can be destroyed. It is possible in cases (as in the buffalo) where that unproductive section can be removed at birth by slaughter, but in the present case this is not possible for, even if sentiment did not stand in the way, the cow is required for creative purposes. It seems, therefore, that in such cases specialization must take place; either a market must be found for the cow or the tract must cease to be self-supporting in the matter of production of working bullocks and must come to rely on import.

Specialization of this nature is a natural development which will slowly but surely come, not only in this, but in other products. It is the natural outcome of facile transport which stimulates centralization of production with interchange of products. There is no reason why this development should not take place in the case of cattle. In practice it means the development of a breeding industry in one tract and farming industry in another, dependent for its supply of working bullocks on the former tract.

That such specialization already exists is well known. In these provinces the Kosi breed is raised in the south-west and large herds of young stock traverse the country. In the Punjab the

Hissar breed is similarly produced in a relatively circumscribed tract ; and instances could be multiplied throughout India. At the present time, however, such specialization is limited and ill organized. Complaints are not infrequently heard that the breeds are dying out or rapidly deteriorating and there is considerable truth in such complaints. The fact is that economic developments, among which must be included the high prices for agricultural produce, have diminished the profits of the breeding industry to vanishing point. Here again it is necessary to find a means of raising profits if the industry is to be re-established. It will be sufficient here to refer to one point only. The breeding industry of England and the Continent is rendered profitable largely by the price realized by the sale of bulls for service. So well recognized is the influence of the bull on the quality of young stock that very high prices are realized for bulls of known pedigree. Compare this with the condition of the breeding industry of these provinces where the income of the breeder is derived almost entirely from the sale of young stock for castration and work ; where it is frequently necessary to give away the bull when it is not without danger that the bull, so given away, will be castrated because its value as a working bullock is greater than its value as a bull. The breeding industry will only be successfully and firmly reinstated, when the true value of the bull is appreciated and when the breeder's income is raised by the sale of bulls. Only so will the breeder be tempted to keep his best animals for use or sale for stud purposes. This is the first essential to check and prevent that deterioration of the breed which is a matter of general comment. It is for this reason that the export of bulls, provided it is restricted to a number in proportion to the size of the herds, is of value. It gives an otherwise lacking premium on the raising of good bulls. It is true, that, in the absence of any local demand, the best bulls may leave the country, but without that stimulus no incentive to retain any but the worst would exist. The recognition of the value of the bull is a matter of much time and of education, but it is of vital importance to the development of efficiency in the cattle of the country.

THE INDIVIDUAL ASPECT.

Hitherto the argument has recognized an animal as efficient or inefficient and the necessity of raising this efficiency has been emphasized. There is, however, another aspect dependent on the fact that an animal passes through a series of stages in the course of its life. From birth onwards it passes through an unproductive period and the owner retains it for its potential value when it arrives at maturity. The cost of maintenance during this period has to be added to its cost during its productive life in any calculation of the efficiency of the individual animal. Later in life it again gradually becomes unproductive and, unless disposed of, the cost of maintenance must also be debited to the productive period. In countries such as England, the "costing out" of an animal has been highly developed, the point where it passes from the productive, to the unproductive, stage is immediately recognized and steps are taken immediately to dispose of the animal as soon as it ceases to be productive.

The trade in cattle, for whatever purpose, is so organized and regulated by competition that such disposal is essential to the maintenance of the industry. This will not carry the cost of maintenance of old and unproductive stock on the present margin of profit which is the result of competition; and it is this competition which prevents any raising of prices. Disposal of such inefficient stock, whatever the cause of the inefficiency, is here rendered easy by the slaughter-house to which such cattle are immediately sent. The slaughter-house is thus an essential adjunct to the cattle industry without which prices for all forms of cattle products and of cattle themselves must rise sufficiently to cover the extra burden or the industry would cease. The necessity for the slaughter-house, therefore, must be recognized. It must be recognized that, to refuse this opportunity for the disposal of inefficient cattle is to impose a handicap of no mean magnitude on the industry. Especially is this the case where, as in this country, the fodder supply is restricted and every mouthful consumed by an inefficient animal is one less from the number needful for the maintenance of efficient. The harm is cumulative for, in the ups and downs of the seasons, periods

of stress arise when fodder shortage may, and does, result in the permanent conversion of an efficient into an inefficient animal.

THE RÔLE OF THE SLAUGHTER-HOUSE.

The slaughter-house, therefore, plays an important part in the economy of the cattle problem and, on economic grounds, is valuable. It should, however, be an outlet for inefficient animals only and it is here that the main objection to the slaughter-houses as conducted in this country lies. On economic grounds they require to be controlled so as to limit slaughter to the inefficient ; there is probably room for improvement in this direction and there is at any rate need for investigation.

THE EFFECT OF SENTIMENT.

In this country however the cow holds a place in the religious beliefs which finds its counterpart nowhere else. Religious sentiment in this direction is so strong that it would be foolish, even were it possible, to ignore it. This sentiment is directed against the slaughter of cattle and particularly against the slaughter-house. It has to be recognized that religious sentiment and economics are here in opposition. The problem, therefore, is to reconcile the sentimental and economic aspects as far as may be possible. The urgent need for a means of disposal of inefficient cattle has already been explained and such disposal is of especial importance in the densely populated tracts where the holdings are small and the head of cattle owned by the cultivator in many cases limited to a single pair ; for, in such circumstances, the possession of a bullock too old to give a full day's work must lead to inefficient cultivation and diminished outturn. If slaughter be unacceptable, alternative, and acceptable, methods of securing the necessary disposal of the inefficient must be explored.

At the present time there are in existence in all large cities *Gaushalas* managed by Committees and supported by funds derived from voluntary contributions which may take the form of a cess on trade, and payment of which has only a moral enforcement. These funds are considerable. The question arises whether these

funds are spent to the best economic purposes or whether some more economic organization, which would be equally in accord with sentiment, could not be devised.

These funds are largely spent in the maintenance of "pinjrapoles" for old and inefficient cattle. Here owners, who are no longer able to support their useless cattle, may deposit them and here such cattle will be fed and maintained until death. The *Gaushalas* also may maintain efficient cattle providing a milk supply and a certain number of young stock; their income is, thus, derived from the sale of milk, young stock and manure as well as from the voluntary subscriptions above referred to. The expenditure is largely for fodder required to maintain these herds.

Characteristic of such *Gaushalas* is the location of the "pinjrapoles" near to, or even within the limits of, the city. Here fodder has to be brought and there is thus to be borne the cost of carriage. Of greater importance, however, is the fact that the required fodder has to be grown within the area in which agricultural prices are affected by urban conditions. Cost of production is high and fodder consequently expensive.

It has to be recognized that these conditions are far from ideal and the funds so liberally supplied in response to sentiment are not expended to the best advantage. There is ample scope for an improvement of organization leading to a more economic utilization of the available resources.

In the first place the dual function of the *Gaushala* requires better recognition. The maintenance of breeding cattle and milch cows requires to be organized on a separate basis on the lines already indicated which are based on a system of raising the milk supplies outside the urban area where fodder, if not really cheap, is relatively so and has not to be transported.

In the case of inefficient cattle this principle can be carried further. The distance to which milch cattle can be removed from the urban area is limited by the necessity of transporting the perishable product to the market. There is no such limitation imposed in the case of inefficient cattle. Here it is merely a question of providing the fodder necessary to maintain existence

till death. For these, therefore, all that is required is the organization of collecting stations for inefficient cattle from which they can be drafted to areas where fodder is cheap. There is little doubt that the present funds could be far more effectively used in the acquisition of "grazing" areas in the less densely populated tracts, such as the submontane tracts in the north; Mirzapur, Bundelkhand and Muttra in the south and the Ganges *kadir* in the west, where considerable herds of inefficient cattle could be maintained at a minimum cost. Such grazing area for inefficients, properly organized with veterinary establishments and fed from collecting stations, would go far to solve the problem of disposal of the inefficient in accordance with sentiment.

RECENT SOIL RESEARCHES AND THEIR APPLICATION TO PRACTICAL AGRICULTURE.*

BY

N. KUNJAN PILLAI, M.A., B.Sc., PH.D.,
Director of Agriculture, Travancore.

AGRICULTURE in India, despite its hoary antiquity, is still primitive and largely empirical. Scientific development which has influenced the progress of agriculture in the Western countries has had but little effect in India. The Indian cultivator is still carrying on his avocation in the same way in which his forefathers had done it. His lack of education, his ignorance of scientific agriculture and his chronic poverty are serious impediments to the adoption of improvements in his methods of cultivation. Small wonder that agriculture carried on under such conditions and circumstances bears no comparison to that of England, America or Japan. A few figures will illustrate the backwardness of India in this respect. The average yields of wheat and barley in England are 1,919 lb. and 1,645 lb. per acre, while in India they are 814 lb. and 877 lb., respectively. The United States of America produces 200 lb. of ginned cotton per acre, whereas India produces only 98 lb. Sugarcane yields about 40 tons per acre in Java and only about 10 tons in India. In the case of rice, which is the staple food grain in India, the average yield is not more than 890 lb. per acre, while in the United States it is 1,400 lb., in Japan 2,100 lb., in Egypt 3,300 lb. and in Spain 5,700 lb. These figures are most astounding and they tell their own tale bringing home to us the deterioration that has taken place in our agriculture.

* Presidential Address, Section of Agriculture, Indian Science Congress, January 1923.

The two great factors concerned in crop production are climate and soil. One is constant and the other is variable. In spite of the great advance made in scientific investigations, we have not yet succeeded in devising measures to change the climatic conditions. We have no power, for example, to reduce the burning heat of the tropical sun or to produce rain artificially. We, therefore, select for cultivation crops adapted to the particular climatic conditions under which we live. Soil, unlike climate, is a changeable factor. To the cultivator it is like clay in the hands of the moulder. He can alter its composition and texture, change its properties, remove its defects and increase its fertility. All this he can do by the proper treatment of the soil. The phenomenal progress that is seen in the agriculture of the Western countries is due primarily to the improvement that has been effected in the treatment of the soil by the application of the discoveries made by the great scientists who are engaged in the investigation of soil problems. I shall endeavour to explain the nature and significance of these investigations and how they have influenced practical farming. I shall also show how inadequate is the attention paid to the solution of soil problems in India and how in consequence our agriculture has suffered. Though I am giving prominence to the investigation of soil problems as a factor in the improvement of agriculture, I do not by any means belittle the importance of investigations in other fields, such as plant breeding, diseases and pests of crops, etc. These are no doubt necessary and even essential, but they are of less importance when compared with the investigation of soil problems. I lay emphasis on this subject because of its paramount importance and also because in India it has not received that attention which it deserves.

Soil consists of inorganic and organic materials. The inorganic portion is derived by the disintegration of the rock-forming minerals and the organic portion by the decomposition of vegetable matter. The mineral plant foods in the soil, such as phosphates, salts of calcium, potassium, etc., are derived from the minerals out of which the soil has been formed. But these by themselves are practically of no value unless supplemented by organic matter,

which is the source of nitrogenous plant food. It is not known when vegetation first appeared on this earth, but it is certain that at one time the earth's crust consisted only of mineral matter. Gradually, lower forms of vegetation grew up. They built up their complex tissues out of mineral matter found in the earth and certain substances in the atmosphere. When they died, their tissues disintegrated and the complex substances broke up into simpler ones. These got mixed with the mineral matter of the earth and thus the formation of the soil was commenced. The cycle of the growth and disintegration of vegetation has gone on for ages and has resulted in the accumulation of organic matter in the soil. It is this constituent, its proportion and the changes it undergoes, that determines the fertility of a soil. Where there is a proper proportion of organic matter and where it undergoes the right sort of changes, there one is sure to find all the conditions which go to make up soil fertility. The success in the investigation of this important problem is the greatest achievement of the modern agricultural scientists. The earlier scientists, namely, Davy, Boussingault, Liebig and others thought that the problems of soil fertility and crop production were almost wholly of a chemical nature and they, therefore, directed their attention to the estimation of plant foods in the soil and to the investigation of other chemical problems. Their chief aim was to find out the deficiencies in the plant food constituents of the soil and to suggest the specific manures which would make up the deficiencies. While acknowledging the services rendered to the cause of scientific agriculture by the chemists, one cannot ignore the fact that too much importance was ascribed to chemical investigations in the earlier days. There was a time when it was generally believed that all that one had to do to raise a bumper crop was to get the soil analysed chemically and apply such manurial ingredients as would remove the deficiencies disclosed by the analysis. It is now a matter of common knowledge that chemical analysis is not always a sure index of the fertility of a soil. All ordinary soils, except perhaps barren sand, contain such a store of plant foods that, if they were all available to plants, they would last for centuries of cultivation. But unfortunately most of them do not exist in

available forms and this fact has only recently been discovered by the chemists. They now know that, in the matter of crop production, what is of great importance is not the total quantity of plant foods present in the soil, but the proportion of those that can be absorbed and assimilated by plants. Even this advance in chemical investigations has not enabled the chemists to solve all the problems connected with soil fertility. Many of these problems remained obscure until the study of the biological changes in the soil was taken in hand by the bacteriologists.

Agricultural bacteriology is a science of comparatively recent origin. The early landmarks may be said to be the discovery of nitrification and of nitrogen fixation by the nodule bacteria. Even prior to these discoveries it was known that fermentation of organic matter was the work of bacteria and that this bacterial action was of considerable importance to agriculture ; but the development of agricultural bacteriology as a distinct branch of science does not go further back than the eighties of the last century. The discovery made by Schloesing and Muntz in 1877, that the formation of nitrates out of the organic nitrogen present in the soil was due to the action of living organisms, can be regarded as the beginning of this important science. Even before that it was known that nitrates could be formed out of organic nitrogen and for many years this process was utilized for the production of nitre on a commercial scale. But it was left to Schloesing and Muntz to prove that the agency responsible for this conversion was a living organism. Subsequently, Warington and Winogradsky continued the investigation and confirmed the results obtained by Schloesing and Muntz. Winogradsky also succeeded in isolating the specific organisms and in cultivating them in pure cultures. He further showed that nitrification, which is the name given to the process by which ammoniacal nitrogen is converted into nitrates, takes place in two stages under the action of two different organisms. This discovery of nitrification has thrown considerable light on the problems connected with the nutrition of plants. I have already explained that when plant residues disintegrate in the soil, complex organic compounds are reduced to simpler substances and that

nitrogenous matter is converted into such materials as will serve as food to the succeeding vegetation. Until the process of nitrification was discovered, it was a mystery how the complex nitrogenous compounds were changed into simple assimilable forms. We now know that nitrogen is first converted into ammonia which is subsequently changed into nitrous and nitric acids and that the latter combines with alkalis or alkaline earths and forms nitrates which the plant is capable of absorbing.

The next great discovery in soil bacteriology was that of Hellriegel and Wilfarth in 1886 in connection with the fixation of atmospheric nitrogen by the organisms living in the nodules found on the roots of leguminous plants. It was found that the bacteria in the nodules, acting in symbiosis with the legumes, absorbed free nitrogen from the atmosphere and converted it into nitrogenous compounds which got mixed with the soil and increased its nitrogen content. The investigations of Hellriegel and Wilfarth were continued by Beyerinck and by Praymowski. The former isolated the specific bacterium, cultivated it in pure culture and named it *Bacillus radicola*.

The discovery of nitrification and of nitrogen fixation brought the science of agricultural bacteriology to great prominence and it has since then attracted a number of workers in various countries whose labours have led to further important discoveries. The investigations of Winogradsky and Beyerinck into the question of nitrogen fixation brought to light organisms other than nodule bacteria, which live free in the soil, having the independent power of fixing atmospheric nitrogen. The most important of these are the *Clostridia* described by Winogradsky in 1893 and *Azotobacter* described by Beyerinck in 1901. Though there is difference of opinion as to the degree of usefulness of these organisms in adding to the nitrogen of the soil under ordinary conditions, there is no doubt that they do possess the power of fixing nitrogen and will exercise it if conditions are favourable or are made favourable to their living.

The problem of supplying nitrogen to the soil is the most difficult that the cultivator has to solve. The little organisms that

exist in the soil can come to his rescue and help him in increasing the store of his soil nitrogen and in making it available to his crops. These are his friends, but he has his enemies also among these invisible denizens of the soil. There is one set of bacteria which under certain conditions mercilessly destroy the good work done by the nitrogen fixers and the nitrifiers. Their function is to break up the useful nitrates and set free the nitrogen in gaseous form. The loss of nitrogen brought about by this process of denitrification is sometimes enormous. From a long series of experiments conducted at Rothamsted it has been proved that from a plot treated with 14 tons of farmyard manure containing about 200 lb. of nitrogen, about 50 lb. is recovered in the crop, 25 lb. remains in the soil, some is lost in drainage water and very nearly 50 per cent. disappears probably as gas. This loss of nitrogen is attributed to the action of denitrifying bacteria which break up the nitrates and liberate the nitrogen gas. Fortunately these destructive agencies thrive only under peculiar conditions. They are as a rule anaerobic and will not be active if the soil is kept loose and well aerated. They are, therefore, not altogether unconquerable enemies.

Recent soil researches have, on the other hand, brought to light another class of enemies more dangerous and more difficult to deal with. They are, according to Hutchinson and Russel, amœboid protozoa present in the soil. These microfauna, it appears, prey upon the bacteria and particularly the beneficent ones. The soil is pictured by the exponents of the protozoa theory as the battlefield of bacteria and protozoa, one always trying to conquer and destroy the other. The fight is said to be analogous to that which takes place in the human body between the white corpuscles and the disease-producing bacteria that have secured an entrance into the blood. In the struggle, if the protozoa wins, the bacteria are put out of action and their activity ceases. When such a stage is reached, the soil is no longer able to supply food to the plant and it is then said to be "sick." It has been proved by experiments that "sickness" can be cured by heating the soil or by treating it with mild antiseptics. In either case the result is the destruction of the protozoa without seriously injuring the

bacteria. In the soil so treated bacterial activity is revived and fertility restored.

The British scientists headed by Hutchinson and Russel are strong adherents to the protozoa theory of the "sickness" of soils. On the other hand, the American scientists of the United States Bureau of Soils explain this phenomenon by their toxin theory. According to them, the roots of plants excrete certain toxins which are detrimental to the development of bacteria or toxic substances may be produced by the action of bacteria themselves. In any case, such toxins, whether excreted by the roots or produced by bacteria, are supposed to check bacterial action and bring about the "sickness" of soils. According to this theory the heating of the soil and the application of antiseptics destroy the toxins and restore soil conditions favourable to the growth of bacteria. Further investigations and more reliable data are necessary to confirm one or the other of the above two theories.

While the investigation of biochemical problems of soil fertility is being pursued vigorously, a new branch of soil science, namely, the physico-chemical side, is also coming to the front. The importance of the application of physico-chemical methods to the study of the soil was the most prominent subject discussed at the meeting organized by the Faraday Society in London in May 1921. The theory put forward by Dr. Russel at that meeting was that the structural framework of soil must be considered as being composed of mineral substances, covered over by a thin clothing of organic and inorganic colloids, with a layer of moisture superimposed thereon. The physico-chemists attach the greatest importance to this colloidal clothing with the help of which they explain away many of the properties of the soil which could not otherwise be explained. The defects of light soils, such as lack of water and poverty in plant foods, are attributed to the absence of colloidal substances. The addition of colloidal humus or clay is found to remove these defects. The improvement of clayey soils by the application of lime is said to be due to the action of lime on the colloidal solution. The accumulation of alkaline salts on the surface layer of lands, which are irrigated without provision

being made for sub-soil drainage, is the result of a physico-chemical action. These are some of the interesting problems of soil fertility which are being solved by the application of physico-chemical methods.

It is evident from what has been said that soil science, which at one time was considered to be but a branch of chemistry, has widened out into a much more comprehensive field including within it not only pure chemistry, but also biochemistry and physico-chemistry. The practical application of the results of the investigations in these two new branches of soil science has revolutionized the system of agriculture in Europe and America. Deep tillage for the free aeration of soil, application of lime to remove acidity and increase bacterial activity, inclusion of a legume in the rotation of crops to enrich the soil in nitrogen, sub-soil drainage to prevent the accumulation of injurious alkali salts on the surface layer, these are some of the important improvements which have been introduced in those countries as a result of recent researches in soil problems. In America, the study of the physical properties of soils has received special attention and the system of "dry farming", which is now so common in that country, is the direct outcome of this study. "Dry farming" is nothing more than the scientific treatment of soil. It is practised in dry arid regions where the rainfall is scanty. The method consists in so manipulating the soil as to conserve the little moisture that is available, by deep and constant cultivation of the soil. In this way lands which have been considered unsuitable for agricultural purposes have been brought under cultivation. The very extensive studies made in the West, and particularly in Germany, of the characteristics of sour and alkaline soils and of the conditions and circumstances under which the formation of such soils takes place, have resulted in the discovery of practical methods of reclaiming such lands and "winning" them over for cultivation. Thus we see how the scientific study of soils has enabled the farmer in the West to increase the outturn from the lands which he is already cultivating and also to extend the area under cultivation by taking in lands which have hitherto been considered unproductive. Agricultural development takes place there both intensively and

extensively and the State is actively helping in this development by granting liberal allotments for scientific research. Hundreds of scientists are engaged in research and have made it their life-work. The Bureau of Soils in the United States, with its various departments of activities and the numerous research workers engaged in each department, is a good example of the thorough and comprehensive manner in which agricultural research has been organized and provided for in the Western countries.

In India, a beginning has, no doubt, been made in agricultural research and some excellent work has also been done. However, one cannot help feeling that the provision that has been made for research and experiment is not adequate and that the result obtained so far is not much. Agricultural research in India has only reached the stage attained by England and Germany in the middle of the last century. When the Agricultural Department was organized about 20 years ago the authorities evidently thought, like the chemists of the earlier part of the last century, that the improvement of agriculture was more a concern of the chemist than of anybody else, and accordingly they set up chemical laboratories and appointed agricultural chemists to solve the problems of Indian agriculture. The result is that we have now a well-equipped chemical laboratory and a large staff of Chemists and Assistants in every province. Next to chemistry, the diseases and pests of crops arrested the attention of Government and hence the appointment of Mycologists and Entomologists was considered essential and they too have come into existence in almost all the provinces. Then came the turn of the Economic Botanists whose work it is to improve the seeds and evolve new strains and, if I am not mistaken, most of the Provincial Agricultural Departments have at present an Economic Botanist also on their staff. The organization for research practically stops at this stage. Chemists, Mycologists, Entomologists and Botanists have done good work in India. The researches of Dr. Leather in Agricultural Chemistry, of Dr. Butler in Mycology, of Mr. Lefroy in Entomology and of the Howards in Economic Botany have contributed to the solution of many problems connected with Indian agriculture, and there is no doubt that the labours of these

scientists and of the numerous other workers all over India will bear ample fruits in the fullness of time. While gratefully acknowledging the services rendered by them, it has to be pointed out that there is a striking defect in the present organization for agricultural research in India. This defect is due to the absence of one link in the chain of experts, a link as essential as or even more so than the other links. This missing link is the Agricultural Bacteriologist. As far as I know, there is only one Bacteriologist at Pusa and another at Madras and even they have only been appointed much later than the other experts.

If agriculture in India is to come up to the standard attained by other countries, it has to be developed both intensively and extensively. Both these are primarily problems of the soil, problems essentially of a biochemical nature for the solution of which a bacteriologist, or, to be precise, a soil bacteriologist is indispensable. The investigation that this expert has to carry out is of a complex and complicated nature. He will, no doubt, be benefited by the work of bacteriologists in other countries, but it will only be useful to him in laying down his plan of operation and in deciding upon the methods to be followed. Conditions in India are so different from those obtaining in Europe that nothing can be taken for granted. Every experiment has to be conducted here as if it were a new one, though it might have been conducted a hundred times elsewhere. We have in India all sorts of conditions the like of which is hardly seen in any other country. We have a climate varying from tropical to subtropical. We have very hot summers and fairly cold winters. We have regions with very low rainfall, while there are places where the rainfall goes up to 200 inches and more. We have arid tracts, rich fertile alluvium and all sorts of intermediate grades of soils ranging between the two. We have crops depending entirely on rain and others which can only be raised by artificial irrigation, while there is one crop, viz., rice, which will grow only under swampy conditions. The biological changes that take place in soils under such widely varying conditions can never be the same, nor can they be like those that take place in cold and temperate climates. The necessity of carrying out original investigations under such

conditions, not at one place, but at different places, in India is, therefore, self-evident. The problems that call for immediate investigation are those connected with the biological changes in the soil. The conditions under which nitrification, nitrogen fixation and denitrification take place in dry lands as well as in swampy rice lands require to be specially studied. Nitrogen fixation by free living micro-organisms has been found to be of comparatively less importance in cold countries. Mr. Hutchinson, Imperial Agricultural Bacteriologist, thinks that under favourable conditions in India this can become a powerful factor in enriching the store of nitrogen in the soil. The special circumstances and conditions favourable to the growth of these organisms have to be investigated. The biological changes that take place in rice lands have not been studied at all. Conditions here are so peculiar that the results of investigations conducted elsewhere are of no avail at all. The action of protozoa and toxins in Indian soils has yet to be studied. The solution of these and other kindred biochemical problems of soil fertility is of paramount importance to the development of Indian agriculture. A correct solution of these problems will place in the hands of the practical farmer methods by which he can increase the productive capacity of his soil or remove the causes that tend to lessen its fertility. Any expenditure on such investigations which are so full of potentialities for the development of agriculture cannot be considered wasteful or unnecessary even in these days of financial stringency and of drastic retrenchments. The appointment of Bacteriologists for the investigation of soil problems is a measure long overdue. No organization for agricultural research can be complete without a Bacteriologist, especially in India where the whole field of soil science practically remains unexplored. It is not enough if we have one or two Bacteriologists as at present. There must be a large number of them scattered over the country investigating soil problems under different conditions. The results that might be obtained at one or two centres would not be capable of general application. The subject is too large and complicated in its various aspects to be dealt with by one or two

investigators. There is room for research in many places and directions.

Young men, especially science graduates who show an aptitude for research, must be selected and trained first at Pusa and then at some institution in Europe or America, preferably the latter, and on their return they should be posted to different centres and provided with ample facilities for carrying out research. The deputation of these men to the United States is specially recommended because the institution that exists there for the conduct of soil researches, viz., the Bureau of Soils, is unsurpassed in the thoroughness of its organization and in the comprehensiveness of its scope and objects. An acquaintance with this institution and its methods of work will be of immense benefit to our prospective soil scientists. The training of young men and the provision of facilities for their work, no doubt, involve expenditure of public money and in these days when the administration of the country is passing into the hands of the people, it may not be quite so easy to provide for such expenditure as it was in pre-Reform period. Popular Government controlled by non-expert legislative bodies are likely to view research from a purely utilitarian standpoint and may not be prepared to encourage it if it does not result in some immediate benefit to the country. It is difficult to convince the lay man of the usefulness of scientific work until he sees the results in practical application. But results are not easily obtained. One has to wait for a long time and encounter many failures before any particular problem could be satisfactorily solved. The State should be prepared to face such failures and spend liberally for the promotion of research. It will do so provided it appreciates the value of research and understands its real importance. Mistakes and failures are unavoidable in any kind of scientific work, but they should not be a deterrent to its continuance. The research worker must go on with his work undaunted by mistakes and failures and he must be allowed to do so unmolested by official red tapeism. Sir Daniel Hall rightly observed on one occasion : " The almost complete sterility of certain State organizations for research on a large scale can be set down to the call that prevails for an annual report of results, only a talent for

advertisement comes to the front under such a regime." In India, however, we want more research as well as more advertisement. The scientific work of the Agricultural Department is little understood or appreciated by the public. The criticisms that are made against the Department are often due to a lack of knowledge on the part of critics. It is the duty of the Department to familiarize the people with the nature of the work it is doing. If once the people are educated to a true appreciation of the value and importance of this work, their representatives on the Legislative Councils will undoubtedly vote more liberal grants for scientific work, and especially for the investigation of such important problems as those relating to soil fertility and crop production, on the solution of which depends mainly the development of agriculture in India.

CHOLAM (*ANDROPOGON SORGHUM*) AS A SUBSTITUTE FOR BARLEY IN MALTING OPERATIONS

BY

ROLAND V. NORRIS, M.Sc., F.I.C., D.Sc.,
Agricultural Chemist, Madras ;

AND

B. VISWANATH,

Assistant Agricultural Chemist.

In a previous paper * it was shown that *cholam* (*Andropogon Sorghum*) is better suited for malting purposes than the other South Indian cereals which are available.

The experiments reported in this paper have had as their object a comparison between *cholam* and barley malts and a thorough examination of the properties of the former, particularly with regard to its suitability in brewing or other operations where malt is used in this country.

The figures given below indicate the close agreement between the average chemical composition of barley and *cholam*.

		<i>Cholam</i>	Barley
Moisture	12.25	14.05
Crude proteins	10.58	10.58
Carbohydrates	69.77	63.66
Fibre	1.58	7.09
Fat	4.14	2.05
Ash	1.68	2.57
Total	100.00	100.00

Assuming that the diastatic activity of the two malts would be of the same order, it was to be expected that the two grains would prove equally suitable in other respects.

The most marked difference in the analytical figures is in the fat content and there is some reason to believe that the higher

* *Mem. Dept. Agri. Ind., Chem. Ser.* vol. V, no. 4.

percentage of fat in *cholam* has a somewhat detrimental effect on the malt produced, hindering the solution of the carbohydrates and leading to a low figure for the "extract." It must also be noted that, though the figures quoted are the average results of a number of analyses, there is frequently present in *cholam* a higher percentage of nitrogenous products which is also a disadvantage to the brewer.

The points which have been examined in the present investigation have, therefore, been:—

1. The malting qualities of different varieties of *cholam*.
2. The influence of the technique of malting on the quality of the malts.
3. The character of the hydrolysis brought about by *cholam* malt and examination of the products.

Throughout the investigation, control experiments have been carried out with barley for purposes of comparison.

I. THE MALTING VALUES OF DIFFERENT VARIETIES OF CHOLAM.

In order to test this point, the following varieties of *cholam* were obtained through the courtesy of the various circle officers:—

Variety	Source
1. <i>Chitrai Vellai Cholam.</i>	Coimbatore.
2. <i>Chinna Manjal Cholam.</i>	Coimbatore.
3. <i>Periya Manjal Cholam.</i>	Coimbatore.
4. <i>Irungu Cholam.</i>	Koилpatti.
5. Type 1. <i>Jonna.</i>	Bellary.
6. Type 2. <i>Jonna.</i>	Bellary.
7. Type 12. <i>Jonna.</i>	Bellary.
8. Type 14. <i>Jonna.</i>	Bellary.
9. Type 32. <i>Jonna.</i>	Bellary.
10. R. 6. <i>Jonna.</i>	Bellary.
11. R. 19. <i>Jonna.</i>	Bellary.
12. R. 21. <i>Jonna.</i>	Bellary.
13. <i>Periya Vellai Cholam.</i>	Coimbatore.
14. <i>Uppam Cholam.</i>	Coimbatore.
15. <i>Talai Virichan Cholam.</i>	Coimbatore
16. <i>Chitla Jonna.</i>	Samalkot.
17. <i>Mudda Patcha Jonna.</i>	Samalkot.
18. <i>Kondu Jonna.</i>	Samalkot.
19. Barley.	Nilgiris.

The malts were prepared in the usual way and, after crushing, ten grammes of each were weighed into 100 c.c. flasks. Sixty c.c. of distilled water at 60°C. were added and the flasks maintained for one hour at 65°C. in a thermostat. They were then cooled in running water, the volumes made up to 100 c.c., with distilled water,

the contents filtered through a dry filter and the amount of extract given by each malt determined. In the case of some, the protein contents of the original samples of *cholam* were also determined in order to see if any relationship existed between the malting values and the protein contents. Malting was carried out in three different ways, viz. :—

1. Rapid germination with a free supply of moisture.
2. Slow germination with restricted moisture.
3. Slow germination as (2) but continued for a longer period.

The results therefore indicate the difference due to changes in the technique of malting as well as the difference between the various kinds of *cholam* tested.

TABLE I.

Extract obtained from different varieties of cholam when malted under identical conditions.

Variety of <i>cholam</i>	% solids in extract by sp. gr.			% proteins in the original grain	Length of radicle at 72 hours couching in cm.
	QUICK GERMINATION WITH PLENTY OF MOISTURE	SLOW GERMINATION WITH MODERATE SUPPLY OF MOISTURE	SLOW GERMINATION WITH MODERATE SUPPLY OF MOISTURE		
	72 hours from couching	72 hours from couching	113 hours from couching		
1 ..	22·00	20·00	42·00	12·31	1·5 — 2·0
2 ..	24·00	20·00	44·00	12·12	2·5 — 3·0
3 ..	32·00	64·00	56·00	11·61	2·5 — 3·0
4 ..	17·00	52·00	42·00	10·39	2·5 — 3·0
5 ..	21·50	65·00	48·00	9·82	2·5 — 3·0
6 ..	24·50	59·00	50·00	11·04	1·5 — 2·5
7 ..	20·00	49·00	44·00	9·50	1·5 — 2·0
8 ..	25·00	66·00	53·00	10·84	2·0 — 2·5
9 ..	18·00	48·00	39·00	12·63	0·2 — 3·0
10 ..	25·00	60·00	45·00	11·16	0·2 — 3·0
11 ..	34·00	61·00	47·00	12·88	0·2 — 3·0
12 ..	33·00	52·00	51·00	12·57	0·0 — 3·5
13 ..	17·00	37·00	11·67	2·0 — 3·0
14 ..	24·00	69·00	49·00	10·85	2·0 — 2·5
15 ..	23·00	69·00	51·00	9·82	2·5 — 3·0
16	69·00	60·00
17	64·00	53·00
18	57·00
19	69·00	66·00	Barley control.

N.B. The numbers in column 1 indicate the varieties of *cholam* as previously quoted. These varieties are referred to under the same numbers throughout.

These results indicate that under identical conditions of malting the varieties of *cholam* tested differ in their malting values. Slow germination continued for a period of 72 hours from the time of couching, combined with a moderate supply of moisture, yields an extract richer in dissolved matter than that obtained when the malting has been carried out under moister conditions. No relationship seems to exist between the protein content of the original grain and the malting values as expressed by the extract. With the exception of a few varieties, such as Nos. 3, 5, 8, 14, 15, 16 and 17, *i.e.*, seven out of eighteen varieties examined which have given high figures, the *cholam* samples yielded much lower extracts than barley.

Influence of fat content of the grain on "extract."

Seven samples were next examined to study the influence of oil content on the extract obtained.

TABLE II.

Fat content of the original grain and the amount of solids in the extract.

No. of sample			% oil as extracted by ether	% solids in the extract
				72 hours germination
1	5.10	20.0
2	4.68	20.0
3	2.63	64.0
5	4.15	65.0
6	3.61	59.0
16	3.00	69.0
17	2.00	64.0

The results are somewhat erratic so that no definite conclusions can be drawn from them. All the grain samples, however, with a low fat content have given high extracts while, with one exception, those with more fat have yielded considerably poorer figures. There is, therefore, some evidence in support of the view commonly held that a high fat content is undesirable in grain used for malting purposes.

Francis and Friedemann¹ have shown that the fat present in *kafr* and *milo*, other varieties of *Sorghum*, consists of six fatty acids, namely, oleic and linolic (80–86 per cent. of the fat), stearic and palmitic (7–10 per cent.), butyric and formic (0·59–0·85 per cent.), while traces of saturated acids higher than stearic acid were found. Barley fat, on the other hand, according to Stellwag², contains 13·62 per cent. of fatty acids, 77·78 per cent. of neutral fat, 4·24 per cent. of lecithin and 6·08 per cent. of cholesterol. *Cholam* fat therefore consists of fatty acids, while barley fat contains chiefly neutral fat.

It will evidently be necessary to study the changes which take place in the fat during germination of the grain before one can say definitely in what way the fat influences the strength of the extract. It is perhaps significant that in the case of grain with a high fat content more prolonged germination appears to be helpful.

II. THE INFLUENCE OF THE TECHNIQUE OF MALTING.

(a) *Steeping.*

Barley or *cholam* or any other grain intended for producing malt is soaked in water in order that the grain may absorb a certain amount of moisture before it is spread out for germination. This is called steeping.

The steeping generally lasts for two or three days and at intervals of about six hours the water is completely drained off and the grains allowed to aerate before fresh water is added. Owing to the absorption of moisture and occasional aeration during the period of steeping, it is likely that changes take place in the chemical composition of the grain which influence the character of the resulting malt. Consequently the period of steeping may also have an influence on the properties of the malt, particularly in view of the relatively higher temperatures under which the process is carried out in this country.

It was therefore considered desirable to study the effect of steeping.

¹ Francis and Friedemann. *Oklahoma Agri. Expt. Stn. Bull.* No. 117, 1917.

² Thorpe. "Dictionary of Applied Chemistry."

A quantity of *cholam*, No. 12 (Type R. 21 of Bellary), was soaked in water for varying lengths of time (24, 50, 64, 72, 90, 96, 114 hours). At the end of the respective periods the soaked grain were removed from the water, drained well and malts prepared and the strength of extract determined in the usual way.

TABLE III.

Results of steeping the grain for varying periods of time. (Laboratory temperature at the time of experiment 28° to 30°C.)
(Type R. 21.)

Duration of steeping	% of solids in extract
24 hours	37.0
50	50.0
64	42.0
72	42.0
90	40.0
96	38.0
114	34.0

Similar experiments were carried out with another variety of *cholam*, No. 5 (Type 1 of Bellary), the results being tabulated in Table No. IV.

TABLE IV.

Results of steeping the grain for varying lengths of time. (Laboratory temperature at the time of experiment 28° to 30°C.)
(Type 1.)

Duration of steeping	% of solids in extract
5 hours	56.0
12 „	52.0
24 „	64.0
36 „	65.0
48 „	65.0
72 „	50.0

The results of the two sets of experiments show that to obtain a malt yielding a good extract steeping should be continued for

periods not less than 24 hours or more than 48 hours under the conditions of malting employed.

III. THE NATURE AND PRODUCTS OF HYDROLYSIS.

The object of the various processes in malting is to render soluble the maximum possible amount of the carbohydrate material of the grain. A knowledge of the changes taking place in the malting beds and the preparation of a sound malt is not enough to secure this end. The mash tun has its part to play because it is here that enzymic activity, particularly of the diastatic enzymes, manifests itself. A knowledge of the various reactions, with special reference to carbohydrates, occurring in the mashing process is essential for their proper appreciation and control.

In this connection we may note that there is sometimes difficulty in the case of *cholam* malt in obtaining a clear wort owing to the small amount of husk associated with the grain.

The next step, therefore, in the course of the investigation, was to study the nature of the hydrolysis of starch by *cholam* malt and compare this with a barley malt hydrolysis.

In the previous report (*loc. cit.*) it was shown that if a solution of starch be employed as substrate and the rate of hydrolysis followed by means of the *iodine test*, the hydrolysis appears to proceed more quickly under the action of *cholam* malt than with barley, while the reverse is seen if the progress of the hydrolysis is followed by the *cupric reduction method*. Large scale repetitions of these experiments confirm the previous observations.

It was therefore deemed advisable to make a systematic study of the nature of hydrolysis of starch by *cholam* malt as compared with barley malt.

In the first place the nature of the final products was examined.

For this purpose 100 grammes of starch were stirred into a paste with about 2,500 c.c. of water and 500 c.c. of the malt extract, obtained from 110 grammes of powdered malt, were added. Ten c.c. of toluene were next added to prevent bacterial contamination and the mixture incubated at 30–35°C. for 10 days. At the end of this period, the solution was raised to the boil and

filtered. The filtrate was concentrated on the water-bath to a third of its volume and treated with an equal volume of alcohol. A flocculent precipitate settled out which was removed by filtration. The filtrate was concentrated and the process repeated, the proportion of alcohol added being gradually increased. The sugar solution purified in this way was then concentrated. The syrupy mass was repeatedly purified by precipitation with boiling 90-95 per cent. alcohol and the cupric reducing power R (per cent. of maltose) of the resulting syrup determined before and after hydrolysis.

		Before hydrolysis	After hydrolysis
Sugar from barley malt	. .	R. 99.3	R. 163.69
Sugar from <i>cholam</i> malt	I	R. 93.7	R. 163.69
Sugar from <i>cholam</i> malt after further purification of No. I	II	R. 97.4	R. 163.69

The syrup was next precipitated with basic lead acetate filtered and washed and the filtrate freed from lead by adding sodium carbonate. The specific rotation and cupric reducing powers of the resulting *cholam* syrup were determined before and after hydrolysis.

Before hydrolysis	After hydrolysis
R. 101.1	R. 165.0
[α D] 138.0	[α D] 53.6

The figures correspond to those of maltose and dextrose respectively. The original purified syrup when tested with phenylhydrazine hydrochloride gave only traces of glucosazone. There is, therefore, no evidence of any formation of glucose, maltose being the final product.

The course of hydrolysis of starch by *cholam* and barley malts at varying temperatures was next closely followed. For this purpose a small quantity of malt extract was added to a large volume of 2 per cent. or 1 per cent. starch paste previously heated to the

temperature of the experiment. Samples were withdrawn at regular intervals and their specific rotation and cupric reduction determined.

TABLE V.
Hydrolysis at 25° to 28°C.

Time in minutes	<i>Cholam</i> R.	Barley R.	Remarks
0	2.7	6.7	
5	11.5	24.0	
10	12.6	42.0	
20	18.0	49.5	By the iodine test the <i>cholam</i> hydrolysis appeared more rapid than barley.
35	25.4	52.9	
50	27.8	53.7	
65	30.0	54.7	
95	34.7	55.9	
125	38.4	56.5	
300	53.2	58.0	
1,275	74.8	63.5	
2,825	80.5	65.8	

TABLE VI.
Hydrolysis at 45°C.

Time in minutes	<i>Cholam</i>		Barley	
	[α D]	R	[α D]	R
0	7.4	..	9.7
15	188.8	31.9	173.7	52.4
30	171.3	49.3	169.8	61.1
45	169.2	55.7	165.7	62.5
60	167.1	61.7	163.4	63.5
90	158.8	65.8	159.1	64.3

(All fractions tested with iodine, *cholam* leading.)

TABLE VII.
Hydrolysis at 66°C.

Time in minutes	Cholam		Barley	
	[α D]	R	[α D]	R
0	2.5	..	3.4
5	199.0	5.4	198.7	3.4
10	7.4	..	10.1
15	197.0	9.8	196.0	13.1
20	195.6	13.1	195.4	15.3
25	194.6	13.9	195.0	15.3
30	194.2	14.8	193.0	17.8
45	192.0	18.1	192.0	20.2
253	182.1	33.3	186.7	30.7
313	33.3	..	32.1

The general inferences that may be drawn from these results are:—

1. *Cholam* malt hydrolysis starch to the dextrine stage at a more rapid rate than does barley malt.
2. *Cholam* exhibits both at normal and at higher temperatures the properties exhibited by barley malt at higher temperatures.
3. Unlike barley malt proportionately larger amounts of dextrans are found in the products of hydrolysis of starch by *cholam* malt at all temperatures.
4. As in the case of barley malt maltose is the final product of starch degradation by *cholam* malt.

This rather striking difference between the behaviour of *cholam* malt and barley malt is of considerable interest and lends some support to the hypothesis held by many investigators that the hydrolysis of starch is brought about by two enzymes, an *amylase* converting the starch into dextrine and a *dextrinase* which is responsible for the further breakdown of the dextrine to maltose. Assuming

this hypothesis there would appear to be in *cholam* malt a larger proportion of amylase and a smaller proportion of dextrinase as compared with barley malt. The dextrinase present in *cholam* malt would however appear to be more stable than that derived from barley malt. For, in the latter case, if the enzyme be heated for a short time to a somewhat high temperature (65°C.) the production of maltose is considerably depressed, an accumulation of dextrine occurring. In the case of *cholam* malt, however, similar treatment has not brought about any such effect. Moreover, though with *cholam* malt the formation of maltose is *comparatively* slow, in all our experiments which have been continued for a sufficiently long period, the maltose production from *cholam* has caught up to and in the end usually exceeded the production of maltose from barley malt.

This aspect of the hydrolysis is being further investigated and will form the subject of a later communication.

SUMMARY.

1. Eighteen varieties of *cholam* have been examined in all. The best of these have given practically the same extract as the barley used as a control.

The conditions determining this result are :—

- (i) Steeping for 36–48 hours before germination.
- (ii) Slow germination with a steady but moderate moisture supply.

2. There is a certain amount of evidence to indicate that the higher fat content of *cholam* tends to reduce the amount of “extract” obtainable from the malt. The amount of fat can, however, be considerably reduced during the malting process under suitable conditions.

3. In a starch hydrolysis the diastatic power of *cholam* malt as measured by cupric reduction appears always, during the earlier stages, to be markedly inferior to that of barley malt. In agreement with this the optical activity of the *cholam* solution decreases less rapidly than does that of the barley experiment indicating the slower breaking down of the dextrine to sugar.

4. If the rate of hydrolysis, on the other hand, be followed by means of the iodine test, our experiments show that the starch disappears more quickly under the action of *cholam* malt than with barley. In other words *cholam* malt would appear to have high powers of saccharification but comparatively low diastatic activity as measured by the ordinary tests of the brewing laboratory. This deficiency of diastatic power is a relative one only, however, and eventually the sugar production from *cholam* malt catches up and frequently surpasses that from barley.

We see, therefore, no reason why *cholam* malt should not replace barley malt for many purposes in this country. The production of malted foods, for example, offers much scope for its use and it is hoped that an enterprise of this kind will shortly be taken up in the Madras Presidency.

TECHNOLOGICAL RESEARCH ON RAW MATERIALS AND ITS RELATION TO PLANT BREEDING.*

BY

B. C. BURT, M.B.E., B.Sc.,

Secretary, Indian Central Cotton Committee.

PLANT breeding, like agriculture itself, is still an art rather than a science, but as the result of the continued application of scientific methods, particularly during the last twenty years, a precision has been rendered possible which was previously unknown. The modern plant breeder, with a knowledge of the economic importance of the unit species or races, which make up the agricultural varieties of crops, and with our ever growing knowledge of the inheritance of characters, can now work on far more definite lines than in the past. But if the analysis of the characteristics of the growing plant has simplified the problem of crop improvement, it has rendered essential an equally thorough analysis of the objects aimed at.

It is usually the plant breeder's object to secure an improvement in the agricultural yield or in the commercial quality of a crop or both. The various factors responsible for yield are now becoming better known or at any rate the importance of such analysis is recognized. Our knowledge of the factors responsible for commercial quality is not so far advanced.

Wheat is grown in order that it may be made into some form of flour, and thence into bread or *chapatties*. Cotton is grown in order that it may be spun into yarn for the production of cloth. But it is by no means simple to state what qualities in wheat enable it to make good bread or what qualities are desirable in cotton in

* A paper read before the 1923 meeting of the Botanical Section of the Indian Science Congress.

order that it may spin well. Recent work, of which that carried on jointly by Mr. and Mrs. Howard with Mr. Humphreys of the Federation of Master Millers and Bakers is probably familiar to you all, has done a good deal to clear up the problem of wheat improvement. Though we are still far from understanding fully the factors responsible for the desirable character called the "strength" of flour, at least methods of experiment and testing have been worked out which enable wheats to be judged for milling and baking qualities and their relative value to the miller fairly accurately gauged. In respect to many other important Indian crops, notably cotton, our knowledge is sadly deficient.

It is not always realized how necessary such knowledge is to progress. All agricultural workers with practical experience in the introduction of new varieties of crops in the general cultivation know that, in order to successfully introduce and establish a new crop or a new variety, it must be possible to offer a definite monetary inducement to the grower. Markets for the major commercial crops are highly organized and in consequence a small quantity of a new commodity or new type, though it may arouse interest, will rarely command its intrinsic value. The reason for this is not far to seek. The manufacturer in most cases does not understand his raw material and relies on empirical knowledge to make up for lack of understanding of the essentials of his problem. The cotton-spinner as a rule spins a certain type of yarn and wishes to be able to turn out the same type month in and month out, with as little variation as possible, with the minimum of trouble and with a minimum of alteration in his machinery and routine. He therefore aims at the purchase of well-known types which he knows from experience to be suitable for his purpose. He avoids strange cottons, for he knows that his judgment and that of his expert graders, based though it is on long experience, is frequently at fault in estimating the potentialities of a strange cotton.

Fortunately this gap is now being bridged, and one of the most marked developments in English technology during the last five years has been the scientific study of raw materials from the manufacturer's standpoint. Under the general guidance of the

Department of Scientific Industrial Research have sprung up a number of research associations dealing with particular industries and supported in no small measure by those industries. In the case of cotton, which is of most general interest to us in India, there are several organizations working for the improvement of the cotton-spinning and manufacturing industry from various aspects. The Empire Cotton-Growing Corporation specializes in the encouragement of improved cotton-growing in various parts of the Empire. The British Cotton-Growing Association, the oldest of all these bodies, now chiefly directs its attention to organizing marketing facilities for new cotton-producing countries. At the moment, however, we are more concerned with two newer organizations, for the scientific study of the fundamentals of cotton-spinning and manufacture. The first of these, the research department of the Association of Fine Spinners and Doublers, is independent of the Department of Industrial and Scientific Research and is really a private concern, but must be referred to here, as it is largely due to the work of Dr. Balls and his colleagues that it has been realized that the gap between the grower and the spinner is capable of being bridged. The British Cotton Industry Research Association, financed in part by the Department of Scientific and Industrial Research, has taken up, as one of its major lines of work, the study of the cotton fibre from all aspects, as well as the study of the changes which take place in the different stages of spinning. Although it has only been working for a short time, results of no little importance have already been obtained and possible lines of further progress clearly indicated.

My immediate purpose, however, is to emphasize the existence of a wide field for investigation in connection with Indian cottons and to state briefly the proposals which the Indian Central Cotton Committee have made for fulfilling what they believe to be a long-felt want. It is possible that further research on the celluloses and on the constitution of the cotton fibre may eventually enable us to predict from the result of laboratory trials how a sample of cotton should behave in the mill. At present there is only one satisfactory method of testing a sample of cotton, viz., to spin it.

As Dr. Balls in his valuable Bulletin on " Spinning Tests for Cotton-Growers " has pointed out, spinning trials in order to be of any real value must be carried out under very strict control and more attention paid to their interpretation than has been the case in the past. But one may also ask why spinning trials are necessary and how the information obtained can be used. Is it not possible for the plant breeder to send his samples to an expert judge of cotton and obtain an opinion on its market value and its merits and defects? Such opinions can be obtained but, unfortunately, they do not in the first place give the information which the plant breeder requires, and secondly opinions from different sources of equal eminence are frequently contradictory for the reason already stated that expert classifiers rely on empirical methods which fail them in dealing with new cottons. Practically every investigator has met with the same experience in submitting his productions for the judgment of trade experts, viz., that trade valuations attach much importance to such points as cleanliness and colour (which to the breeder are of secondary importance) and are not sufficiently definite in regard to the intrinsic characters of the cotton.

Spinning tests can be carried out in commercial mills, but only with difficulty and to a limited extent. In the first place, testing involves great disturbance of the routine of a mill. In the second place only by a very special routine can small samples be handled on full-sized mill machinery. The result is that the cost to a mill of carrying out spinning trials on strange cottons is frequently out of all proportion to the information obtained, unless such trials are carried on a scale only possible when some hundreds of acres of the new cotton have been grown. It is nevertheless essential that facilities should be provided for the proper testing of new cottons for various agricultural workers in India who are engaged on cotton improvement. Lack of such facilities in the past has undoubtedly led to undesirable types of cotton being brought into cultivation—types which, though they have for the moment proved profitable to the cultivator, are not liked by the spinner and which are ultimately discriminated against.

The Indian Central Cotton Committee has proposed the establishment in Bombay of a small Technological Research Department for cotton, where practical spinning tests can be carried out on small samples (which in case of need can be as little as 5 lb.), where such tests can be pushed to their logical conclusion and the potentialities of a new cotton fully investigated. It has been definitely ascertained that this is a practical proposition and that suitable machinery can be obtained at reasonable cost. It is hoped that this scheme will be given effect to during the present year and that before long it will be possible to definitely state in regard to a sample of new cotton its advantages and drawbacks from a spinner's standpoint and what counts it is suitable for spinning.

But in order to give the plant breeder the maximum assistance more than this is required. In the first place, even with special experimental plant, there is a limit to the number of spinning tests which can be carried out, particularly when the samples are very small. In the second place, it means some delay if a plant breeder is to wait until he can produce even 5 to 10 lb. of cotton before a test can be made, since he frequently needs to determine while he has still only a few plants whether a given strain is worth further study or not. A second branch of the Technological Department's work, therefore, will be the study of the measurable physical characters of cotton fibres and their relation to spinning value. In this respect there is still much room for development. The work of Dr. Balls and his colleagues has given us convenient laboratory methods for determining accurately the true length of the staple of cotton and its uniformity and also the true strength of cotton fibres although these have not yet been applied to Indian cottons. Recent work has shown that length and strength are not the only factors, and may not even be the critical factors, in determining how a cotton will spin, and examples have been quoted of both Indian and Egyptian cottons which on actual test spun far higher counts than their length of staple would indicate. It has also been shown recently that the breaking of cotton yarn depends not so much on the strength of the individual fibre as on the slipping of one fibre over the other

and is hence probably a function of the length of the fibre, of its diameter and tensile strength but also of what, for want of a better term, we must call its clinging power. The latter is often spoken of by practical spinners as the natural twist of the fibre; recent work would indicate that it is closely connected with the elasticity of the fibre. *

Nor should the bearing of technological research on market organization be overlooked. It is not generally known that considerable attention was paid to this point in America during the five-year optional period prior to the introduction of the new compulsory universal standards for American cotton. In our efforts to improve the organization of primary markets the necessity of suitable organization in the major markets must not be forgotten. At present Indian cotton is sold too much on "station name" and too little on intrinsic merit. We have not at present the information to frame a scientific trade classification of Indian cottons badly as we need the latter.

The object of the research now being conducted in England is to achieve a better understanding of cotton as a raw material and of what happens when it is spun. In India no small amount of work has been done from the agricultural aspect, but to complete the latter and obtain full value for it we need research on the spinning value of our cottons and the factors involved.

I venture to suggest that we have here another instance of those fascinating border-line problems the study of which in the past has so often been the beginning of a new advance in knowledge.

* Attention is also invited to a recent paper by Pierce (*Jour. Text. Inst.*, January 1923) on the rigidity of cotton hairs. [B. C. B.]

THE SECOND VETERINARY CONFERENCE, CALCUTTA.

At Calcutta during the week commencing 26th February, 1923, a conference convened by the Government of India was held of the senior officers of the Indian Veterinary Service, under the presidency of Colonel G. K. Walker, C.I.E., O.B.E., F.R.C.V.S., Principal of the Punjab Veterinary College. The members were assisted in their deliberations by Lieut.-Col. F. H. G. Hutchinson, C.I.E., Public Health Commissioner with the Government of India, representing the Indian Medical Services, Lieut.-Col. W. A. Pallin, C.B.E., D.S.O., Assistant Director of Veterinary Services, Eastern Command, representing the Army Veterinary Services in India, Mr. W. Smith, Imperial Dairy Expert, representing the Agricultural Services in India, and Mr. T. Bainbrigge Fletcher, R.N., F.E.S., F.L.S., F.Z.S., Imperial Entomologist. The Conference was called together by the Government of India to discuss questions bearing a more particularly professional or technical interest to the Service, for administrative questions of interest to it are now dealt with at meetings of the Board of Agriculture, to which officers of the Veterinary Service are invited. The Conference held at Calcutta was the second meeting of officers of the Veterinary Service; the first meeting was held at Lahore in 1919.

A heavy programme was laid before the meeting for discussion, including items dealing with veterinary education, contagious diseases of animals and general problems.

Veterinary Education.

The section of the agenda dealing with education was the subject of important discussion. The Public Services Commission, 1912-14, had recommended that a proportion of officers of the Provincial Service grade should be admitted after further training to the Imperial cadre, and that as soon as possible steps should be taken to institute courses of veterinary education in India teaching

SECOND VETERINARY CONFERENCE, CALCUTTA, 1923.



Back Row—Capt. G. G. Howard, Mr. R. Branford, Mr. F. Ware, Mr. T. F. Quirke, Major R. F. Stirling, Mr. Krishnamurti Iyer
 Standing — Mr. W. H. Priston, Mr. E. S. Farbrother, Mr. R. T. Davis, Mr. W. Harris, Mr. C. J. N. Cameron, Capt. S. G. M. Hickey,
 Mr. D. Quinlan, Mr. P. J. Kerr, Mr. A. D. MacGregor, Capt. P. B. Riley, Mr. N. Muhammad,
 Sitting — Mr. C. W. Wilson, Mr. J. T. Edwards, Lt.-Col. W. A. Pallin, Col. G. K. Walker, Lt.-Col. F. H. G. Hutchinson, I.M.S.,
 Mr. K. Hewlett, Mr. T. B. Fletcher.

up to the highest standard, so that the needs of the Imperial Service could be met from graduates trained in the country. A trial course of instruction for men selected from the Provincial Service with a view to promotion to the Imperial grade has already been commenced in India, at the Imperial Bacteriological Laboratory, Muktesar. The deputation of these men to England for training was held to be undesirable by expert advice.

As the outcome of a resolution passed at the first Conference in 1919 a special meeting of the Principals of the Veterinary Colleges assisted by the Director of the Muktesar Laboratory and the Veterinary Adviser to the Government of the United Provinces was held at Bombay in February 1922 to draft a scheme of veterinary education for the training of Indians in India to the highest standard, as recommended by the Public Services Commission. A four years' course of study was carefully drawn up by this meeting and the system of training was held to represent the minimum needs in instruction and teaching resources for the primary education of Indians up to the standard indicated by virtue of the rapid advances in knowledge in veterinary science. This meeting moreover recommended the establishment of a Central Advisory Board to deal with general questions concerning veterinary education throughout India, and it further stipulated that selected Indians who had passed successfully through this course might be made eligible for promotion to the Imperial Service after undergoing a prescribed course of post-graduate instruction in India. After examination of this system the Government of India believed that it was so thorough and exacting from a financial aspect that it would probably not be adopted for many years to come at the Indian Veterinary Colleges, and it was suggested by the Secretary of the Department of Revenue and Agriculture that the Conference might examine the practicability of establishing a Central College for all India equipped for the teaching of the small number of graduates that would be required to fill the higher posts and would need the higher training; he suggested further that possibly Muktesar, with its advantages of climate and technical resources, might be found most suitable for this purpose.

In view of these developments, the first question discussed at the Calcutta Conference was whether any revision was necessary of the conclusions arrived at by the first Conference at Lahore and the subsequent meeting of Principals at Bombay. The members unanimously agreed that the Bombay programme represented the minimum requirements for the training of students to the standard demanded by the Public Services Commission. The establishment of a Standing Committee on Veterinary Education was very strongly recommended, and this Committee should be empowered to make minor modifications and additions to the curriculum as warranted by circumstances ; in particular it was considered that the institution of a satisfactorily high standard of preliminary education should be a matter requiring the utmost vigilance. The feeling among the members was that Muktesar, largely on account of the absence of clinical material, was unsuitable for this course of primary veterinary education, and they recommended that an endeavour should be made to establish it immediately at one of the existing colleges. At the Punjab Veterinary College a course of veterinary study extending over four years has recently been introduced, and, as far as buildings and material equipment are concerned, this institution ranks among the foremost in the world. With the development of its teaching resources, particularly for instruction in the subjects which are of prime importance to graduates destined for service under the State, namely, the study of the basic principles, and the subjects tributary to a proper understanding of preventive medicine, this institution might well be adapted for the higher course of training drafted by the Bombay meeting last year. The officers at Calcutta, moreover, suggested that as soon as financial circumstances permitted of the establishment of an efficient organization to teach this rapidly developing side of veterinary science, the higher course of training should be established also at the other colleges.

Unfortunately, however, the adverse circumstances prevailing in the country at the present time, notably the financial stringency which precludes the satisfactory extension of the teaching institutions generally so as to fit them to impart a veritable education in

veterinary science as opposed to instruction in mere methods of practical treatment without an underlying basic training for the comprehension of the wide problem of health and disease, and secondly the paucity of teachers of sufficient capacity to impart a rational teaching, render impracticable the general adoption of the satisfactorily high standard of veterinary education. The meeting thus resolved that less costly shorter courses must continue.

The general outlines of training for the shorter courses were referred to a representative committee and considerable discussion took place among its members on the length of time necessary for a course of training which did not pretend to teach up to the standard fully demanded by modern requirements. The prevailing opinion was that a three years' course represented the minimum period necessary even for the training of men of the present Veterinary Assistant class. The President and the Secretary of the Conference (the Director of the Muktesar Laboratory) strongly contested this view and held that two years' training would be sufficient to produce men quasi-empirically for the lower grades in the Service, who would have no pretensions to a rational knowledge of veterinary science; the establishment of a course of training much shorter than that required for the adequate training of men for the higher ranks would have as its natural outcome the institution of two well differentiated cadres in the Service, whereas a three years' training would be quite inadequate for the inculcation of a sufficient knowledge of the science and it might lead its graduates to aspire without reason to the higher ranks. It is true that many living members of the profession in England underwent a two years' course of training at the British Colleges, and a number of distinguished members undertook their training when the course was of only three years' duration. There is at the present time, however, a demand for the extension of the course of training from four years to five years at the British Colleges, for it has been represented that the march forward in our present knowledge of disease in animals has been so rapid that it is not possible to assimilate even a rudimentary knowledge of the basic subjects and contributory

sciences which fit a man for the comprehension of the single problem of disease and health in a shorter period and that for a State service this comprehension is indispensable for the officer who has charge of the control of the economically incalculably important problem in the public welfare, namely, contagious diseases in the domesticated animals. A training of shorter duration than that regarded by students of animal disease to be the minimum necessary for acquiring an understanding of the problem can but lead generally to the production of partially trained men without sound conceptions of their calling, and if we are to be content in India with a second-rate product for the present it is as well to draft this individual, for the most part by selection, and if possible from the classes connected with animal husbandry, without insistence upon the adequacy of his preliminary scholastic education. Again, the emoluments held out to the Veterinary Assistant are not sufficiently lucrative to attract recruits who possess a high standard of initial education. One is constrained therefore to regard the unfinished product of a shorter course largely as a mechanic to his profession and it was held by the two above designated officers that a two years' training would be ample for this purpose, but that with three years and a low standard of entrance examination difficulties of the nature alluded to above might be subsequently encountered : through the development of a consciousness that there existed but a difference between the higher and the lower training the graduate in the mechanical arts might regard himself entitled to promotion by reason of the capacity he might feel he had displayed in his subsequent career. Nevertheless, it was strongly pointed out by the Principal of the Bengal Veterinary College that owing to the very large number of gazetted and other holidays claimed by students at his college, with, consequently, a relatively small number of working days in each scholastic year, it would be impossible to instil into the minds of students a satisfactory knowledge of the art of the veterinary surgeon in a shorter time than three years. A three years' scheme of study was therefore adopted by the meeting and a syllabus drafted indicating the subjects for study in each of the three years of the course, now deprived completely of the basic instruction in the great natural sciences, which

previously the veterinary colleges had endeavoured to teach in their curriculum. A relatively low standard of entrance examination was demanded, with the sixth standard examination as the minimum standard.

On the general question of promotion among the various cadres of the Service, the Conference decided that the promotion of subordinate members of the department to the Provincial Service should be left in the hands of Local Governments and their Advisers, but that it is desirable to impart to the men selected for promotion a suitable form of post-graduate instruction, with safeguarding tests, the nature of which should be decided by the Local Governments concerned. The subordinate members of the Service include men of the "Veterinary Assistant" and "Veterinary Inspector" grades, while those belonging to the Provincial Service are designated "Veterinary Deputy Superintendents" when employed in field administrative duties or are occupied as professors or as lecturers at the colleges.

Further, it was recommended that in view of the Government policy providing for the promotion of a proportion of Provincial service officers to the Imperial Service, this mode of promotion should be restricted to those officers who have at least ten years' service remaining to the credit of Government, whose selection is approved by one of the Standing Committees of Imperial Officers (mentioned later), and who undertake to submit themselves to a course of special work and pass certain specified tests prescribed by this Committee.

The general opinion of the meeting was that men selected for direct appointment to the Imperial Service should possess the diploma of the Royal College of Veterinary Surgeons. In view of the sounder scholarship demanded by the duties of an Imperial Officer in the Indian Veterinary Service than is usually required by a graduate of the Veterinary Colleges whose career is spent in general clinical practice, it was also recommended that recruits should possess, in addition, a degree in Veterinary Science of a British University. On account of the preponderating importance of the ox as a domesticated animal in India preference should,

moreover, be given to those who have taken steps to observe the methods of cattle practice during their course of study. On arrival in India the selected recruits should undergo a course of instruction at the Imperial Bacteriological Laboratory at Muktesar and, subsequently, instruction in animal husbandry and dairying at the institutions concerned with these pursuits in India.

In recommending methods for affording facilities to the various grades for instruction after graduation the meeting decided that post-graduate courses of study should be provided for Veterinary Assistants at all the existing veterinary colleges and the syllabus for these courses should be approved by the Central Advisory Committee. The institution of post-graduate courses of study for Provincial officers at Muktesar or elsewhere was approved and the courses of study imparted at such institutions should be examined by the above Committee. Facilities should be given to Imperial officers to undergo post-graduate training at Muktesar and abroad.

Contagious Animal Disease.

The existing position regarding some of the economically highly important diseases of live-stock in India was discussed with a view to elucidating better methods of control.

ANTHRAX.

On account of the economical situation now likely to arise from international action for the prohibition of importation of wool infected with anthrax into manufacturing countries this disease was down for major discussion. The conference was fortunate in having at its deliberations Lieut.-Colonel Hutchinson who had just returned from the last meeting held in London of the Special Committee of the International Labour Organization of the League of Nations, appointed to consider steps in regard to safeguarding wool workers against infection. The incidence of anthrax infection—the so-called wool-sorters' disease—amongst workers at Bradford had become so high that the Home Government had appealed to this organization to advise all Governments with a view to taking

international action to eliminate this industrial menace. It appears that East India wool, hair and hides are infected with anthrax spores to a surprisingly high degree, and India is on the whole perhaps the worst offending country in this respect. The official returns, however, would seem to indicate that anthrax is a comparatively rare disease in animals in India, but it was elicited in the course of discussion among the members that it is undoubtedly a serious disease of live-stock in the country—far more serious than the published figures would indicate—and the apparently low incidence of infection would be due to the present very unsatisfactory systems in vogue of notifying animal disease. As the result of investigations undertaken by a departmental committee appointed by the Home authorities, a very satisfactory method of disinfecting wool has now been evolved, and a trial disinfecting station has been established at Liverpool. The cost of the disinfection itself, however, exceeds the export price of the wool, and at the present time it makes the utilization of East India wool prohibitive to manufacturers if these steps are insisted upon. There is no satisfactory method at present published of disinfecting hides that will not cause deterioration from a manufacturer's standpoint. If action is taken upon the recommendations of the International Committee it appears likely that India will soon be faced with the alternative of setting up and maintaining expensive disinfecting plant for the treatment of all wool exports or, on the other hand, of making adequate provision for the elimination of the disease from her flocks and herds if she is to retain her export trade in these products. The efforts already made by the Government of India with a view to introducing the necessary legislative measures for dealing with the disease were recounted by the Director of the Muktesar Laboratory.

After having considered in detail the incidence of anthrax among animals in India, and in men handling animal products in other countries, and the economic issues resulting therefrom, the Conference resolved, first, that as the spread of infection is not limited by geographical and provincial boundaries, measures directed against the dissemination of the disease, both in India and to and from India from other countries, should be considered a central

subject; secondly, that disinfection of animal products, while throwing a great financial burden on industry, will accomplish nothing towards the eradication of the disease in animals and thereby improving the condition of live-stock in the country; thirdly, that the only sure way of dealing with the situation, and at the same time of lasting economic benefit to the country, is by making a persistent effort to prevent the spread of infection among animals, and thereby secure control and ultimate eradication of the disease.

It was considered that the success of any measures designed with these objects will depend upon, first, efforts to improve the agency for notification; secondly, an increase in numbers in the veterinary personnel of all grades consistent with the work which has to be done; thirdly, improved facilities for the education of the veterinary personnel recruited in India in the problems connected with the control of epizootic disease; and, fourthly, legislation.

RINDERPEST.

The most formidable scourge of cattle, namely, cattle plague, or rinderpest, exacts annually a heavy toll among the bovine population of India. Fortunately, a remarkably efficacious serum is now available for combating the disease, and this is manufactured at present in large quantities at the Imperial Bacteriological Laboratory, Muktesar, for the purpose of protecting cattle exposed to danger of infection in the various parts of India. One of the chief functions of the Veterinary Services in the provinces is to detect outbreaks of this disease as early during their onset as possible and prevent the spread of infection by administering serum to the cattle still free from the disease but liable to become infected. Serum protection, however, confers but a "passive" immunity, as it is called, of fleeting duration, and in the scene of persisting infection the inoculations have to be repeated at intervals of less than a fortnight while the outbreak lasts. When properly applied in this manner the spread of infection should be rapidly checked and the disease extinguished. Unfortunately, however, there are no means

of enforcing inoculation upon the owners of susceptible live-stock at the present time, with the result that there remain in the scene of an outbreak uninoculated animals capable of keeping the infection alive for an unlimited period of time. The important question was therefore raised as to whether some better method of immunization could be adopted at the present time. A method of conferring a permanent, lifelong, immunity ("active" immunity) has long been known, and this method depends upon setting up the actual disease in the animal by inoculating it with a minute quantity of blood taken from another animal at the height of the infection and minimizing the severity of the reaction by inoculating it simultaneously with a suitably large dose of protective serum. This method, known as the "serum-simultaneous" method, has been successfully adopted on the cattle in the Military Dairies in India, but for certain technical reasons accidents are sometimes likely to occur. The Director of the Muktesar Laboratory recounted the main results of researches which have been strenuously prosecuted at the laboratory during the past year with a view to obtaining more light on the nature of this disease. The Conference was of the opinion that the process of active immunization against rinderpest should be prosecuted with the utmost vigour whenever possible, as it represents the only means at present known of conferring a satisfactory permanent immunity upon susceptible animals. In the districts, however, the time is not yet opportune for the wholesale performance of this method, as the occasional accidents which follow upon its adoption might hinder, in view of the prejudices of the smaller owners, the eventual universal adoption of the method. Further, it considered that investigations upon the nature of the rinderpest virus and upon the factors involved in the safe conferring of a satisfactory immunity should be regarded as research projects of primary importance. It was believed that meanwhile, until the time arrives for the wholesale adoption of the process of active immunization, the use of the method involving the inoculation of serum alone should be regarded, when properly applied, as the system best suited for general adoption in the face of outbreaks [in India.

SURRA.

The most serious contagious disease of horses and camels in India is that known as surra, caused by the presence in the blood stream of a small whip-shaped parasite known as a trypanosome, and similar in this respect to the formidable diseases afflicting human beings and animals on the continent of Africa, known by the names respectively of sleeping-sickness, nagana or tse-tse fly disease, and other names. In the past, serious outbreaks of surra have greatly hampered the progress of military operations in India, notably in frontier expeditions. A characteristic of the great majority of diseases of this class is that they are conveyed from the infected to the susceptible, healthy individual by the agency of a blood-sucking fly. In the case of the important African trypanosomiasis the species of fly responsible for the transmission of the disease are well-known, and it is also now known that certain of the trypanosomes undergo a definite life-cycle in the body of the fly before they become again capable of infecting a susceptible animal when it is bitten by the fly. Up to the present time the species of fly responsible for the transmission of surra in India are not definitely known; recently, some interesting work has been done by Mr. Cross, Camel Specialist under the Punjab Government, on the possibility of ticks acting as transmitting agents. On account of the great danger to military operations represented by this disease, together with its ravages among privately owned animals, the Government of India constituted a standing committee to deal with the matter, and at its fourth meeting in 1921 it recommended the provision of a whole-time staff of experts (Pathologist, Protozoologist, and Dipterist) to investigate the disease for a period of years. Largely for financial reasons, this staff has not been provided. At the present time the disease is controlled under the Glanders and Farcy Act, which provides for the destruction of horses and other animals found infected upon examination of their blood. It has long been known to be undoubtedly true that cattle and other animals frequently harbour the trypanosome of this disease in their blood, without suffering any visible ill-effects; occasionally, however, the infection may take a fatal issue in cattle. Moreover,

there is recent evidence to hand that the so-called surra trypanosome is not the only trypanosome present in animals in India, for in the Central Provinces a small trypanosome, identical in appearance with one well-known to cause disease in cattle in South Central Africa, has been found. It was recommended very strongly by the Director of the Muktesar Laboratory that the whole class of diseases due to minute animal parasites (protozoa) needs immediate investigation, for little exact knowledge is yet available concerning the group of affections particularly frequent in cattle in India caused by certain organisms (peroplasms) which are not unlike the parasites of human malaria; researches at Muktesar had shown that a parasite identical in appearance and location with the causal organism of the formidable East Coast fever of cattle in Southern Africa is present in cattle in India, but from the meagre evidence available it does not appear to be the cause here of serious disease. Moreover, it is now wellknown that certain drugs exercise a profound effect upon parasites of this class, notably upon certain of the trypanosomes. Investigations upon the trypanosome infections in small laboratory animals with various classes of drugs, best among which were found to be the organic arsenical compounds, led Ehrlich to select eventually the well-known product in his series (606) now widely used in the treatment of human syphilis. Quite recently, a drug known as "Bayer 205" has been evolved by a German firm of chemists which appears to cure human sleeping-sickness and, if further trials warrant the assertions made upon the preliminary results, the effects of this treatment will be so far-reaching in rendering habitable large depopulated tracts in Central Africa that it has been suggested that the German Government propose to make the disclosure of the composition of this drug the basis of negotiations for the return of certain of their lost African tropical possessions. A line of treatment which in certain circumstances gave very promising results in the cure of surra in horses was worked out by the late Colonel Holmes when he was Director of the Muktesar Laboratory. More recently, Mr. Cross in the Punjab has obtained very encouraging results in the treatment of military camels with tartar emetic. The Director of the Muktesar Laboratory

strongly urged the prosecution of researches in curative treatment upon naturally infected cases in widespread areas with the collaboration of all the available veterinary resources in India. The Imperial Entomologist presented to the meeting a review of the published information upon the problem of surra transmission, and recounted his efforts aimed at the centralization of all the entomological resources in India.

The Conference decided that investigations into the nature and mode of transmission of the animal trypanosomiases in India should be prosecuted forthwith, and, likewise, the whole problem of the important protozoan diseases of the domesticated animals in the country should be approached concurrently. For this purpose it will be necessary to strengthen the technical resources at present available in the country for research into the different aspects of these projects, comprising the entomological, protozoological, and pathological aspects, by the centralization of the facilities available in each of these pursuits and the delegation, on request, of workers to assist those engaged directly in the elucidation of the actual disease problems. It was considered that an experienced protozoologist should be appointed to the staff of the Imperial Bacteriological Laboratory for research into these problems, and that entomological assistance should be derived from the staff of the Imperial Entomologist. The workers would find unlimited scope for their activities, particularly in the investigation of the economically highly important diseases of live-stock caused by protozoan parasites other than those of surra. Efforts to obtain a cheap, effective, and easily applied remedy for the cure of surra, in particular, and other protozoan diseases should be prosecuted on a large scale in the laboratory and in the field, and the co-ordinated services of the whole veterinary profession in India are required for this purpose. With regard to legislation it was held that in view of our present inadequate knowledge of the trypanosomiases of animals in India and the likelihood that the pathogenic trypanosomes find a reservoir frequently in relatively resistant host species, the present legislative measures dealing with surra should be reconsidered in the light of better information that may be procured.

on further research directed with the object of elucidating these peculiar conditions.

CONTAGIOUS ABORTION OF MARES AND CATTLE.

Evidence was brought forward before the meeting by the Director of the Muktesar Laboratory that the common form of contagious abortion affecting mares was highly prevalent in certain of the large breeding studs in the Punjab, and that recently tests upon one of the large military dairy herds had disclosed a very large proportion of animals affected with the common form of contagious abortion in cattle. The micro-organisms responsible for the cattle disease and the mare disease are different, and a peculiarity of both infections is their capacity for remaining latent in the infected animals for long periods of time; meanwhile, the animals are carriers of the disease. Fortunately both conditions can now be detected by means of a simple laboratory test, and the diseases can be controlled in suitable circumstances by the segregation of the infected animals. In civilized countries, where the cattle breeding industry is carried on intensively for economic purposes, contagious abortion has now assumed the position of the most serious disease of stock to cattle owners, for it interferes greatly with breeding operations and the milk supply. It even ranks before tuberculosis from the standpoint of the owner, for whereas this latter condition assumes importance mainly to the public on account of the dangers from an infected milk supply, contagious abortion is the cause of an incalculable amount of direct loss to the breeder himself. In India these insidious conditions which occupy a foremost position in hampering the unlimited propagation of live-stock in Western countries are largely masked by the widespread occurrence of the much more visibly rampant plagues of cattle, chiefly rinderpest and hæmorrhagic septicæmia, but with the establishment of an adequate organization for the control of these scourges and greater attention to the problems of animal husbandry it would undoubtedly be found that contagious abortion is by no means a negligible factor in breeding operations, and the experience of Western countries might be largely repeated. The

Conference decided that further investigation should be prosecuted in regard to the origin of these diseases in mares and cattle, their regional distribution, the susceptibility of the various classes of live-stock to infection, and the institution of proper measures of control.

TUBERCULOSIS.

Hitherto tuberculosis has been assumed to be an extremely rare disease of cattle in India, and in the large herds of cattle kept for the supply of milk to the troops in India no authentic cases have been detected until quite recently, when apparently a single case was found. Investigations at certain slaughter-houses, however, have shown that about three per cent. of the cattle admitted as fit for slaughter were infected; in the great majority of cases the disease caused very little apparent damage in the animal body, but recently evidence has been obtained of natural infection in indigenous cattle simulating the acute type found often in cattle in Western countries. Experimental work done in recent years seems to point either to a relatively low susceptibility of Indian cattle or to a lower virulence of the type of organism responsible for the disease in the cattle of the country. Lieut.-Col. Hutchinson pointed out that with regard to tuberculosis in human beings in India we were still groping largely in the dark, but it was certainly true that in the large industrial centres the disease was the cause of high mortality. It is also undoubtedly true that the disease is now assuming serious proportions in certain rural areas, apparently by migration from the industrial centres. Investigations have now conclusively shown that a very large proportion of the cases of tuberculosis found in children and of the type affecting bones and joints, the so-called closed type of the disease, is of bovine origin. Although the types of organisms, human and bovine, responsible for tuberculosis in India have not yet been investigated, evidence shows that the proportion of cases of the closed type of tuberculosis found in the country corresponds exactly with that found in Western countries. It is perhaps probable that as cattle live for the most part in the open in India, the factors which contribute towards the

rapid spread of tuberculosis among European herds do not obtain to an equal degree. The importation of cattle infected with tuberculosis from abroad is now prohibited or safeguarded against under rules drawn up by Local Governments under the Live-stock Importation Act, 1898.

After an interesting discussion, the Conference found that the evidence available shows that tuberculosis is present in cattle in India, but is insufficient to indicate to what extent it prevails. Further, in view of the experience gained in other countries with regard to the spread of infection in susceptible animals, it is clearly indicated that steps should be taken to ascertain accurately the prevalence of infection. Research into the nature of the organisms responsible for the disease and the relative susceptibility of the various breeds of cattle should be prosecuted forthwith. If this research should indicate that tuberculosis is at present rare among Indian cattle, measures should be taken to eradicate it and to limit as far as practicable the introduction of the disease from outside sources. The Conference was of opinion that these measures are urgently demanded by reason of the grave dangers to the live-stock of the country, the purity of the milk supply, and the catastrophies of bovine tuberculosis in children.

WORM AND INSECT PARASITES.

During the latter portion of the last century the study of the grosser parasites of men and animals fell into neglect, due very largely to the transcending interest attached to the microscopic parasites in connection with the serious contagious diseases and the rapid improvement in the methods of studying these minute parasites and their effects upon their hosts. During the last decade or two, however, interest has again become focussed on the enormous economic importance of the grosser parasites. In man, hookworm disease is now known to be of almost world-wide distribution and is a prominent contributory factor to the inefficiency of the poorer classes, notably in hot climates. The importance of the condition is now being recognized and commendable efforts are now being made to bring it under control by surveys and propagation of

curative treatment by the Hookworm Commission of the Rockefeller Foundation. In animals, diseases due to the grosser parasite assume incomparably greater importance. The losses caused by liver flukes and stomach worms in sheep and cattle are wellknown in Western countries. In tropical countries, disease due to these parasites is even more accentuated on account of the peculiar climatic and humidity conditions therein which favour their development. In India the study of these parasites has been undertaken only to a very small degree and, here again, it appears that the relatively greater importance attached to the rapidly fatal scourges has distracted attention from the more insidious disease conditions due to the worm parasites.

The Conference resolved that in view of the enormous economic loss caused by, and our present inadequate knowledge concerning the presence and the nature of the species of, parasitic worms present in animals in the country, the appointment of a whole-time helminthologist to investigate the subject of helminthology from the standpoint of animal disease is urgently required in the interests of owners of live-stock in India, and it was suggested that this officer should work under the direction of the Imperial Bacteriological Laboratory.

On account of the great importance of insects in the transmission of animal diseases and as causes of direct injury to live-stock in India, and the high degree of specialization necessary for a proper appreciation of the various aspects of entomology, it was recommended that the staff of the Imperial Entomologist should be strengthened to the degree requisite for rendering assistance to investigators engaged in the study of animal diseases.

Similarly, it was held that facilities should be afforded for the establishment of a staff attached either to the Imperial Entomologist or to the Zoological Survey of India for the study of the ticks and mites concerned with animal disease.

RABIES.

The control of rabies in India constitutes one of the most difficult problems confronting both medical and veterinary

authorities. Measures of control are difficult on account of the large numbers of ownerless dogs in the country and the susceptibility of wild animals—jackals and other animals—to infection. In Japan, preventive vaccination of dogs on a large scale has been undertaken on lines similar to the well-known Pasteur treatment for human beings bitten by suspected dogs. The method has yielded apparently highly encouraging results. For some time past a similar method of treatment has been carried out on a relatively small scale upon dogs at the Punjab Veterinary College. It was intimated to the meeting that experiments are now in progress with a view to devising a suitable method of vaccination at the Madras Veterinary College working in conjunction with the Pasteur Institute of Southern India. Mr. Krishnamurthi Ayyar of the Madras College declared that the experiments in progress had not been yet pursued to the degree that would place him in a position to announce definite results. The Conference therefore resolved that the results of investigations upon the prophylactic vaccination of dogs against rabies should be referred to the Central Standing Advisory Committee on Epizootic Diseases and Research (proposed under a subsequent resolution) with a view to advising Government upon the desirability of enforcing measures of widespread inoculation of dogs against the disease.

INFECTIOUS LYMPHANGITIS AND CONTAGIOUS NASAL GRANULOMA OF CATTLE.

Two very interesting papers were read by Mr. Krishnamurthi Ayyar upon his researches into these two diseases in Southern India, illustrated by numerous mural charts and diagrams, preserved specimens, and microscopic preparations. He adduced evidence which pointed to the bacterial infection in the first named condition being transmitted by certain species of lice. Nasal granuloma seems to be a widespread disease of cattle in India, and the Muktesar Laboratory reported cases investigated from Assam, Bihar and Orissa, and the Bombay Presidency. The condition clinically resembles somewhat rhinosporidiosis and rhinoscleroma in man and in the peculiar growths in the nasal chambers, granular formations,

first discovered by Mr. Krishnamurthi Ayyar, are found which bear a resemblance to those seen in the condition very prevalent in cattle and sometimes found in man in other countries and known as actinomycosis.

SHEEP DISEASES.

The subject of sheep diseases, brought forward by the Superintendent of the Government Cattle Farm at Hissar in the Punjab, was discussed by the Conference and it was held that on account of the economic importance of disease in these animals in India further steps should be taken to render assistance to sheep owners by means of propoganda and by the education of the veterinary personnel in the peculiar problems connected with the chief classes of disease affecting sheep.

General Veterinary Considerations.

Discussions took place on the following topics of general interest to the Veterinary profession in India.

LEGISLATION.

At the present time the legislative measures enacted by the Government of India are quite inadequate to enable Local Governments to bring under control the prevalent contagious animal diseases. The measures now in general application are the Glanders and Farcy Act, which deals with glanders in horses and surra in horses and other animals, and the Dourine Act, for the control of the disease known by this name in horses. In Madras a Cattle Diseases Act has been in force since 1866. After careful consideration by the Conference it was unanimously agreed that the time was ripe for the introduction of a general central measure on the lines of the Diseases of Animals Acts, 1875 and 1894, in Great Britain, whereby the Ministry of Agriculture is empowered to draft orders for dealing with certain diseases scheduled under the Acts. It was thus resolved that a Diseases of Animals Act should be introduced as early as possible to give permissive powers to Local Governments to frame rules for the enforcement of sanitary police measures for the control of contagious diseases in animals.

STATISTICAL.

At the present time the Government of India publishes an annual statistical report giving figures for the mortality from the various diseases in the country compiled from the returns furnished by the Civil Veterinary Administration Reports of the various provinces. These returns are now the only evidence forthcoming for the guidance of those interested abroad, commercially or technically, with regard to the state of animal health in India. It was pointed out at the meeting that reliable statistics of this nature would be of inestimable value to professional workers and administrative authorities in the country. Discussion, however, revealed that these returns as at present compiled are wholly unreliable; there was no uniformity in the channels of notification in the various provinces—in some the Revenue Authorities undertook the work and in others the Police; in some provinces there was no means of inflicting penalties for delinquency on the part of the minor officials, while in most provinces there was apathy on the part of owners to intimate deaths and evidence showed that there was often wilful concealment of deaths, while again the small value of the individual animals, the frequency of deaths due to other causes than contagious diseases—such as malnutrition and overwork—all contributed to the unsatisfactory state of affairs with regard to our real knowledge of the incidence of contagious disease. In Lower Burma, the system of reporting appears to be much better devised and a Cattle Deaths Register, which is checked from time to time, is kept by each village headman. After discussion, the Conference resolved that in view of the administrative and professional importance of obtaining reliable statistics in regard to the mortality incidence in animal disease, a more thorough system of notification than the present very unsatisfactory systems in vogue should be investigated immediately and introduced. Further, the system approved should be, as far as possible, uniform in its application throughout India.

ANIMAL HUSBANDRY.

As was pointed out to the meeting by the Imperial Dairy Expert, the problem of the ox represents the most universal

problem in India. Agriculturally, the problems confronting the cultivator in respect of his crops differed greatly from province to province, depending upon climatic, soil, rainfall and other factors; but, without the ox his work could nowhere be carried on, and as his tillage depended upon the efficiency of the ox, disease in this animal was likewise an universal problem, so that veterinary assistance was everywhere indispensable. However, he pointed out that no improvement could be effected in the breeding of cattle without enlisting the enthusiasm of the private owner. Further, if the ox was to become an economically paying proposition, the question of increased milk production must be intimately linked with that of improved draught qualities. Hitherto, attention had been paid to improvement in draught only, while increase in milk production in the same animal had been wholly neglected. The only solution to the economic problem was the production of the dual purpose animal. The formation of a Central Cattle Board to deal with the general question of improvement in the breeds of cattle in India had been the subject of a resolution at the meeting of the Board of Agriculture held at Pusa last year. The Veterinary Conference strongly favoured the formation of Cattle Boards, both Central and Provincial, and deemed it essential that the veterinary profession should be adequately represented on these bodies.

SUPPLY OF SERA.

A discussion took place on the possibility of devising improved methods for the transport of sera and other laboratory products in a good state of preservation particularly with a view to supplying the needs of remote districts. The Director of the Muktesar Laboratory stated that he was in process of investigating the efficacy of a desiccated anti-rinderpest serum obtained by drying the serum at a low temperature by means of a special plant. The Conference recommended that adequate cool storage facilities should be provided in all provinces where such facilities do not already exist for the conservation of serum. Further experiments regarding the possibility of manufacturing a satisfactory dried anti-rinderpest serum should be prosecuted as speedily as possible, and in the event of

failure to obtain satisfactory results from these experiments some more convenient method of transporting the liquid serum should be devised.

MEAT INSPECTION.

In certain municipalities a demand for trained meat inspectors has now arisen and it was particularly asked by Lieut.-Colonel Hutchinson if the veterinary colleges were in a position to supply this demand. The Conference intimated that training in meat inspection is now provided at certain veterinary colleges in India and can be extended in scope as the demand for efficient meat inspectors increases.

DUPLICATION IN VETERINARY EFFORTS.

In certain districts of the Punjab and the United Provinces a considerable amount of overlapping of duties takes place between officers of the civil veterinary service and the veterinary staff attached to the Remount Department of the Army. It was decided that the system of controlling equine contagious disease in these districts represents an unsatisfactory duplication in veterinary endeavour, and the suggestions embodied in the note presented to the meeting by Mr. Quirke, Superintendent, Civil Veterinary Department, Punjab, were commended to the notice of the authorities concerned.

CORRELATION OF TECHNICAL INFORMATION AND THE RENDERING OF AUTHORITATIVE ADVICE UPON PROFESSIONAL PROBLEMS.

Finally, as the outcome of a most instructive discussion on the correlation of technical information and the rendering of authoritative advice upon professional problems it was decided that (a) A journal of veterinary science in India should be established as early as practicable ; (b) Central Standing Advisory Committees should be established dealing with (i) Veterinary Education, (ii) Civil Veterinary Administration, and (iii) Epizootic Diseases and Research.

The Conference invited the attention of Government to the Report of the Advisory Committee on Research into Diseases in Animals presented in February 1922, to the Development Commissioners and to the statement contained therein that, "in India immense opportunities are almost wholly neglected." The Conference strongly advocated the allocation of funds for research, which, while removing this stigma, would be of great economic benefit to the country. Further, it was stated, that it is now generally recognized that the problem of disease and health, whether in men, animals, or plants, is in reality one problem; hence no real advance in the study of disease is possible without co-ordination of all workers in this field. (J. T. E.)

Selected Article

GETTING ALONG WITH THE BOLL WEEVIL.*

ABANDONING HOPE OF SUPPRESSING THIS PEST, THE SOUTH CONSIDERS
THE PROBLEM OF ITS CONTROL.

BY

HARRY A. MOUNT.

THE cotton boll weevil completed its conquest of the cotton belt in the United States in 1921. In that year 66,662 square miles of additional cotton territory was infested by the pest, and there remains uninfested only a little fringe of cotton-producing land, containing only scattered plantings and producing only 5.4 per cent. of our total cotton crop.

Furthermore, the boll weevil, over a total of more than 600,000 square miles of infested territory in this country, has been more active and more destructive in the past two years than at any period in the thirty years since the little beetle crossed the Rio Grande into Texas and began its steady, relentless conquest.

Entomologists and agriculturists who have been fighting the pest all of these have given up hope that the boll weevil ever can be eliminated. Literally, the weevil has won its place in the sun and the pressing question no longer is, how we may be rid of it, but how can we get along with it ?

The advent of the boll weevil in the South has wrought an economic revolution. The old slipshod farming methods no longer pay, and from force of sheer necessity the South is turning to scientific agriculture as the chief means of relief from its dilemma.

* Reprinted from *Scientific American*, February, 1923.

The South is undergoing a great awakening, of tremendous significance, not only locally, but to the whole country and to the world.

There is a world panic in the industry using cotton as a raw material, for the South not only supplies all of the cotton needs of this country, but half of all the cotton used by the rest of the world. In no other spot are climatic, soil and economic conditions so favourable to the cheap production of cotton. A great association of English cotton mills is making desperate efforts and spending thousands of pounds in an effort to find another region from which they may draw a supply if the South should give up this important crop.

Egypt, India, South Africa, Brazil and Australia all produce some cotton, but an intensive study of these countries has forced the conclusion that they can never be a source of abundant cheap cotton.

Our Department of Agriculture has recognized the necessity for scientific diversified farming, but at the same time is urging strongly that cotton be retained as the "money crop" of the South. Cotton can still be produced at a profit over most of the infested area under methods of intensive culture and close control. Only in a few spots which are particularly favourable to the boll weevil has cotton culture been abandoned entirely. One such region is the coast of the Carolinas, where the famous sea island cotton has been grown. The weevil thrives particularly well there and so we now have to import a long staple Egyptian cotton to take the place of our once famous product.

In order to understand the nature of the situation which the boll weevil has brought about, we ought to know some of the things which our scientists have learned about the bug in thirty years of study. It is not a native of the United States and had its first home probably in the plateau regions of Mexico or Central America. Before it appeared in the United States it had spread over much of Mexico.

In 1892 a small area of cotton fields in the neighbourhood of Brownsville, Texas, was discovered to be infested with the

weevils. Dr. L. O. Howard, now Chief of the United States Bureau of Entomology, who was then in the employ of the State of Texas, made an investigation and at once recognized the destructive possibilities of the insect. He prepared legislation which was introduced in the State Legislature providing for a quarantine of the infected area. The bill was laughed at and pigeon-holed and the final chance of ever checking the boll weevil in the United States was lost.

The very next year the area infested was quadrupled and from that time until the present the area of destruction has been steadily extended, until now practically the whole cotton belt is infested.

It may seem strange to the average layman that in all these years, during which hundreds of scientists have been engaged in the fight on the weevil, no method of extermination has been found. The explanation is that it is not the adult weevil which does the damage, but the larvæ which hatch from the beetle's eggs. The beetle chews a hole into the young cotton "squares" or buds and deposits the eggs deep inside. The cotton plant itself heals over the wound with a gummy secretion that makes an effective seal over the eggs. The egg develops and the young weevil is born and thrives in a sealed compartment, where he is perfectly safe from any amount of poison.

It is possible to reduce the damage to some extent by spraying the plants with poison at the time the adults are laying their eggs. But the weevil has enormous recuperative powers, and although only a few beetles may survive the poison brigade, they produce enough offspring to repopulate the field with their kind. The possible production of offspring from a single pair of weevils in one season is estimated at 12,755,100. But nature has provided enemies which prevent such excessive multiplication. Chief among these are heat and cold and other insects which prey upon the weevil. Only from 2 to 11 per cent. of the adult insects ordinarily survive the winter season, but these few survivors are quite sufficient to retain full possession of a field, and even to extend their domain.

Natural control agencies vary greatly in effectiveness from season to season and from field to field, and this introduces an element of uncertainty in cotton growing which is most discouraging to the farmer. This much is sure : once infected a field will remain infected as long as cotton is grown there.

Almost countless methods of control have been suggested and tried, but all except one have been discarded as useless. Dusting with powdered arsenate of lead after the "squares" have become about 10 per cent. infected effects sufficient control to more than pay for the cost--provided the yield of the field is naturally large. It is generally true that it no longer pays to raise cotton on land which normally produces less than a half bale of cotton per acre. Scientific methods of fertilization are, therefore, a first necessity.

The weevil itself is from a quarter to a third of an inch long, and from light brown to gray or black in colour, depending on age. About a third of its length is taken up by a stout snout. The insect passes the winter in the adult stage, taking no food and remaining practically dormant. The beetles emerge from their hibernation from March to June and begin their life work--reproduction. The eggs inside the cotton "squares" hatch in about three weeks and the grub immediately begins to gorge itself on the tender leaves of the immature bloom. In from seven to twelve days the larvæ pass to pupa stage (corresponding to the cocoon of the butterfly) and in from three to five days more the adult issues and the process is repeated. The average adult life is about fifty days in summer.

As soon as cold weather approaches the weevils begin to hunt winter quarters and they fly away from the field in every direction. But the weevil is a weak flyer and he is usually carried with the prevailing winds. Thus the weevil extended his reign eastward much faster than northward or westward. In fact the weevil infested cotton fields on the Atlantic seaboard before he reached fields in the northern and western part of Texas, only a few hundred miles from the place of entry into the United States.

The total annual damage of the insect is conservatively estimated to exceed \$8,000,000, while the total damage done by the boll weevil in this country is thought to be between \$200,000,000 and \$300,000,000. But in spite of the rather hopeless aspect of this situation the United States is still by far the greatest cotton-producing region in the world, and that leadership will no doubt be maintained. What the South has lost through the boll weevil it has more than recovered by better farming methods.

The fact that successful cotton raising now requires intensive culture reduces the acreage required to produce a given amount of cotton. This has released land formerly used for cotton for other crops and in many cases has resulted into breaking up the large plantations into smaller farms.

This turning to diversified farming, as against the old single crop system, has secured for the South a degree of economic independence heretofore unknown. The average Southern family living on a farm in the "good old days" actually had to buy a great deal of the family food which could have been raised there, and nearly all of the food for horses and mules.

Unfortunately the South cannot compete with other sections in raising such staple crops as corn and wheat. But sweet potatoes and pea-nuts are typical Southern crops of growing importance and rice culture is coming to be a great Southern industry. Besides this the growing of sugarcane is profitable in many sections and market gardening to supply both the cities of the South and northern centres of population can be carried on practically the year round. Southern melons, fruits and berries are already famous in Northern markets.

The productivity of Southern soil planted in vegetables may be judged by these instances authenticated by an investigator for the Department of Agriculture.

At Cliffside, N. C., a garden of three-fourths of an acre, tended at old times by a family of four, with an expense of \$5 for preparation of the soil and \$2 for seeds, raised eleven kinds of vegetables with a market value of \$97.65. A workman, at Charlotte, N. C., on five-eighths of an acre at a total expense of 15 cents for seed (he

had saved his seed from the year before), raised dry beans, cabbage, turnips, peas, onions, beets, cucumbers, tomatoes, sweet corn, and peppers in one season with a market value of \$92. An investigation of 950 Southern farms showed that the home garden now yields food for the family at a value of about \$94 a year, a great part of which formerly was purchased.

The Southern market gardener has the advantage over his Northern competitor (who now supplies the bulk of the market produce in a long growing season) in a short mild winter, and no need for expensive equipment to keep winter vegetables. Almost all of the market vegetables grown in the North will thrive also in the South and a number of these can be grown which cannot be raised elsewhere. The development of direct refrigerator car routes to the centres of population solves the heretofore serious problem of getting this produce to market in good condition.

This turning to diversified, scientific farming as a result of the boll weevil's depredations has so greatly improved the condition of many Southern communities that the expression is frequently heard that the boll weevil has been a blessing. Actually, one Southern town has erected a monument to the boll weevil because of the awakening which has taken place in that vicinity.

Undoubtedly also the boll weevil has been instrumental in the great industrial progress of the South in the past few years. Negroes who have lived on small patches of land, producing little more than enough for their own sustenance, are moving to the cities and they make up the last great reservoir of cheap labour in this country.

However undesirable this may be from a sociological point of view, it has the effect of attracting industry. The industrial development has awakened the South to its great natural resources, and these are being rapidly developed. In the South are 62,000 square miles of bituminous coal lands, more than in England, Germany, France and Austria combined. There are more deposits of iron ore than in all Europe. The South is producing about half of the world's sulphur supply. It has the only important known deposits of phosphate rock, the foundation of a great fertilizer industry.

It has over 40 per cent. of all the standing timber in the United States. In addition to this it has great, almost untouched, deposits of marbles, granites, clays and building stone unsurpassed anywhere else in this country.

All this may appear to be going rather far afield from the subject of the boll weevil, but it helps to explain how, in the face of what is considered by many the greatest calamity ever suffered by an agricultural section, the South is steadily meeting the world's demand for cotton and at the same time is consolidating her economic position in such a way that another such calamity can probably never occur again.

Notes

NOTE ON SOME SUGARCANE JUICES RECEIVED FROM RANCHI FARM.

IN a previous number of this Journal (Vol. VII, Part I, January 1912, p. 23) attention was drawn to the striking effect of climate on the richness of sugarcane juice. Observations carried out in the writer's laboratory during the seasons 1920-21, 1921-22 and 1922-23 have given a series of results, which are of sufficient interest to publish, as they show the effects produced on the juice by three distinct seasons of which one differs markedly from the other two while the others differ to some extent.

The experiments in question were carried out at Sabour with juices sent by the courtesy of Mr. Cliff, Deputy Director of Agriculture, Ranchi, who also sampled and crushed the canes giving the figures of expression from which the amount of saccharose on cane per cent. has been calculated. The system followed was to sample the juice and to send it to Sabour in bottles which had been dried and sterilized by the addition of corrosive sublimate. The juice will keep almost indefinitely in this way, without change, a fact which was found of great use during the railway strike of 1922, when the juices were sometimes as much as four to five days on the way. The observations during the season 1920-21 were carried out at rather irregular intervals of about a fortnight, but the results appeared to be of interest and for the last two seasons regular series of analyses have been carried out every ten days.

The table which follows will show the main analytical results, which show the progressive ripening of the cane. Fluctuations are found as is to be expected, but the ripening in each case is seen to be progressive.

The outstanding features of this table are:—

- (a) The saccharose, glucose ratio and quotient of purity show that the cane ripened by the third week of December in 1920-21, while both the glucose ratios

and quotients of purity show that in 1921-22 and 1922-23 it was not mature until the second week of February or nearly two months later.

- (b) In both 1920-21 and 1921-22 the maximum saccharose in juice was about 15 per cent. and that extracted on cane about $11\frac{1}{2}$ per cent., while in 1922-23 it has given over 17 per cent. saccharose on juice and an extraction of about 12 per cent. on cane.
- (c) In 1922-23 the glucose ratio gives indications that the cane actually became dead ripe only in the first week of March.

It will be of interest to look for the causes of these phenomena. Now, the ripening of the cane is of course determined by the period at which the sugar stored up begins to exceed the amount required for growth energy. The main cause of ripening then is likely to be some change in the climate which will cause the cessation of growth.

In Northern India, the seasons are so marked that the growing period of the cane is probably very largely determined by their alternation, and it is natural to look for a change in the seasons, as a cause of such marked variations as we have seen above (this of course presupposes that the canes are uniformly cultivated in each case). In the case of such early ripening as was observed in 1920-21 it is natural to look for a sudden frost. Graphs were prepared with the help of the meteorological tables for the two periods 1920-21 and 1921-22 and it was found that the minimum temperature graphs at Ranchi during the two seasons lie remarkably close together, and that there is nothing in the recorded temperatures that would justify the assumption that they could have caused the check shown in 1920-21. The ripening occurred just at the beginning of December in the case of the more delicate canes (Red Tanna was not one of these) and the types of temperatures experienced at that time are shown below :—

Average minimum temperatures at Ranchi.

			1920-21	1921-22
November	1st - 10th	..	61.0	56.5
„	11th - 20th	..	58.2	54.9
„	21st - 30th	..	55.0	52.6

Table showing the ripening of a typical cane "Red Tanna" during the seasons 1920-22.

Time of analyses	Saccharose % in juice			Glucose % in juice			Glucose ratio		Quotient of purity			Saccharose expressed % of cane			REMARKS	
	1920	1921	1922	1920	1921	1922	1920-21	1921-22	1922	1920	1921	1922	1920	1921		1922
1st week of Dec.	11.00	12.66	..	1.68	1.80	..	15.27	14.22	..	76	76	..	8.4	9.2	The crushing was done in a small iron mill.
2nd " " " ..	14.75	10.25	13.44	1.26	1.88	2.14	8.54	18.34	15.92	83	70	79	..	7.6	9.7	
3rd " " " ..	14.58	10.00	12.66	0.58	1.07	2.00	3.95	15.75	15.80	88	70	74	11.6	7.3	9.4	
4th " " "	11.82	15.03	..	1.51	1.46	..	12.78	9.73	..	75	84	..	8.7	11.1	
2nd " " Jsn. ..	14.90	12.16	14.86	0.58	0.85	1.63	3.89	7.00	10.97	85	74	83	10.4	8.7	10.6	
3rd " " "	12.26	14.83	..	1.13	1.30	..	9.22	9.07	..	78	81	..	9.5	10.8	
4th " " " ..	14.80	14.00	15.55	0.79	0.82	1.48	5.38	5.76	9.52	84	84	84	11.2	11.2	11.1	
2nd " " Feb.	14.19	17.50	..	0.71	1.11	..	5.00	6.34	..	80	87	..	11.4	12.7	
3rd " " "	17.19	1.05	6.11	90	12.3	
1st " " March	15.10	17.22	..	0.88	0.92	..	5.83	5.40	..	87	90	..	11.6	12.7	

From the above figures it will be seen that the mean minimum temperatures in November 1920 were actually higher than those in 1921-22, so that it is necessary to look further afield for the cause of the sudden ripening. An indication is furnished here by the fact that the wet bulb temperatures at 8 a.m. were lower in the earlier part of December 1920 than those at the same time in 1921.

This is shown by the following table :—

Average minimum temperatures at 8 a.m.

	1920-21			1921-22		
	Max.	Min.	Mean	Max.	Min.	Mean
November 10th-20th	62	54	59	57	51	54
,, 21st-30th	58	48	52	56	52	54
December 1st-10th	54	45	49	57	53	55
,, 11th-20th	52	46	48	55	46	51

This table illustrates the fact that the humidity in 1920 was much less than in 1921, a fact which was known to be true and which is well illustrated by the accompanying table and graph (Chart I).

Mean humidities at 8 a.m.

	1920	1921	1922
November 1st-Nov. 10th	60	57	57
,, 11th- ,, 20th	60	52	61
,, 21st- ,, 30th	43	60	76
December 1st-Dec. 10th	43	71	67
,, 11th- ,, 20th	43	58	73
,, 21st- ,, 30th	48	60	73
,, 31st-Jan. 9th 1922	43	72	61
January 10th-Jan. 19th	56	66	59
,, 20th- ,, 29th	73	70	55
,, 30th-Feb. 8th	52	57	57
February 9th- ,, 18th	45	43	78

CHART I.

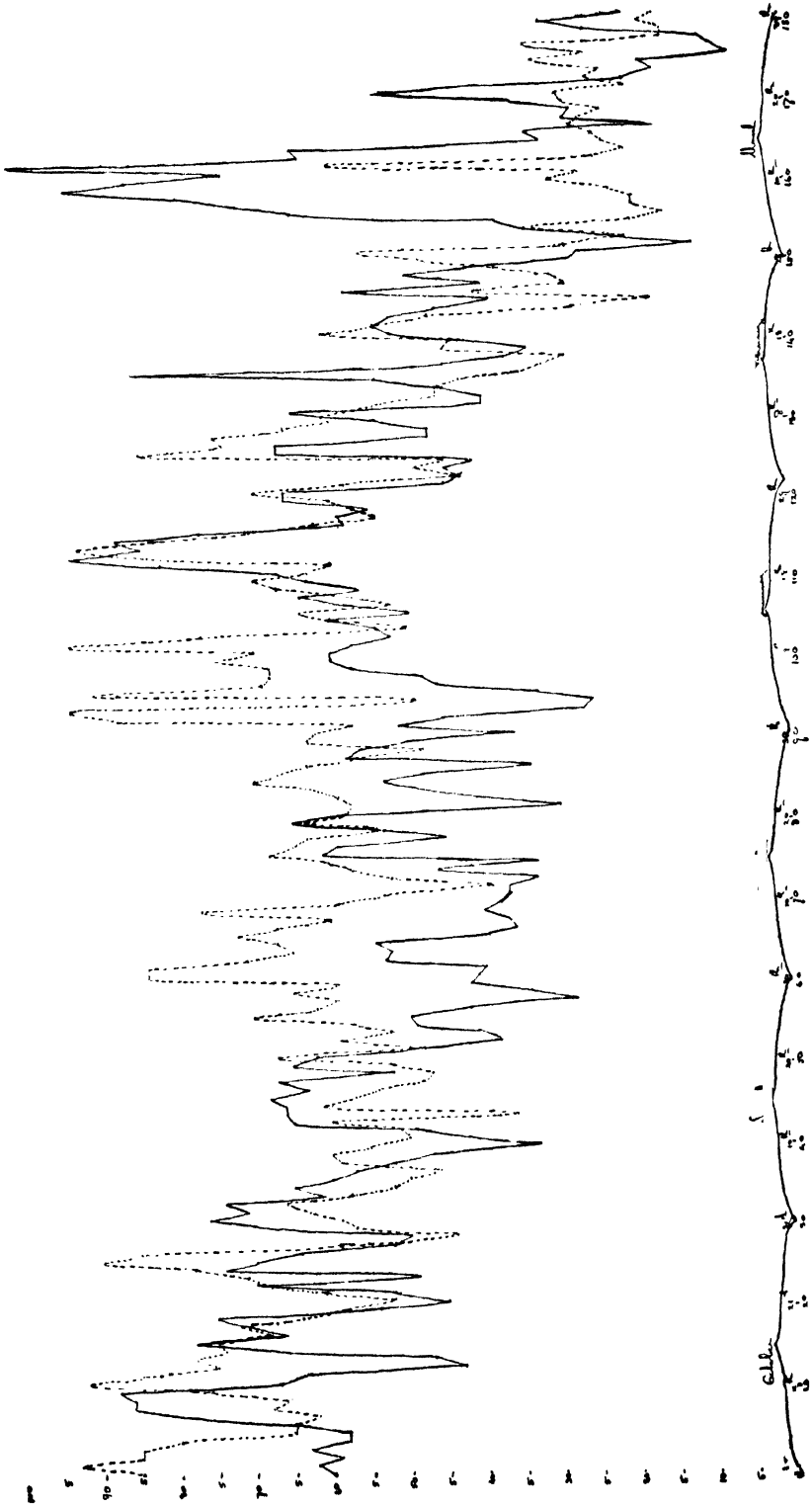

The continuous line shows the course of the relative humidity in 1920-21.

The broken line shows the course of the relative humidity in 1921-22.

From these figures it will be seen that the mean humidity was about the same at the beginning of November 1920, 1921 and 1922. There was a sharp drop in the third week of November 1920 which was not recovered until well on in January, while in the other two years there appears to have been no drastic period of drought. The abnormally early ripening of the canes in 1920, therefore, may quite possibly have been due to this sudden early drought, which caused rapid lowering of temperature at the surface of the growing leaf, where, of course, wet bulb temperatures prevailed. As has been seen above, these wet bulb temperatures were fairly low and were well below the minimum temperatures recorded. [C. SOMERS-TAYLOR.]

* * *

AN IMPROVED FORM OF KJELDAHL APPARATUS.

IN consequence of the necessity of carrying out a large number of nitrogen estimations by the Kjeldahl method, the fume cupboard accommodation in this laboratory was found inadequate; the writer therefore designed a piece of apparatus for acid digestions which could be operated in the open laboratory without inconvenience from the acid fumes produced. The design of this apparatus is shown in the accompanying diagram, from which it will be seen that the acid fumes are caught at the mouth of the flask by a special adapter and drawn off by the action of an ordinary glass filter pump through which they pass into the drains in solution in the water. One filter pump will deal successfully with six flasks, with a fair head of water in the main, but in practice it is more convenient to limit the number to four.

In addition to the removal of fumes by the pump, the modified design of the stand holding the digestion flasks results in economy and better distribution of the heat of the gas burner besides shielding the flame from draught. This is effected by the introduction of a metal cone, the crenellated upper edge of which affords a better distribution of heat than the usual circular asbestos ring; a further improvement consists in the use of a copper asbestos support shown separately in the drawing which rests on the top of the metal cone and minimizes chance of breakage from irregular local heating. As

DIAGRAM I.

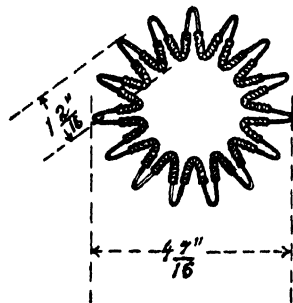
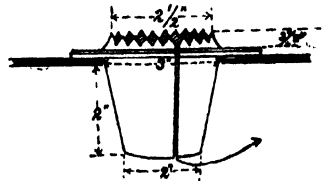
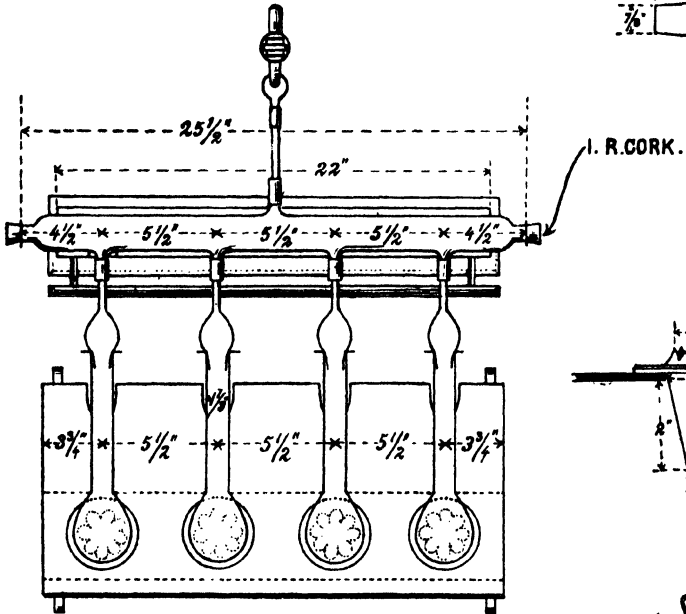
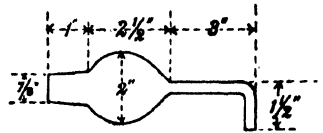
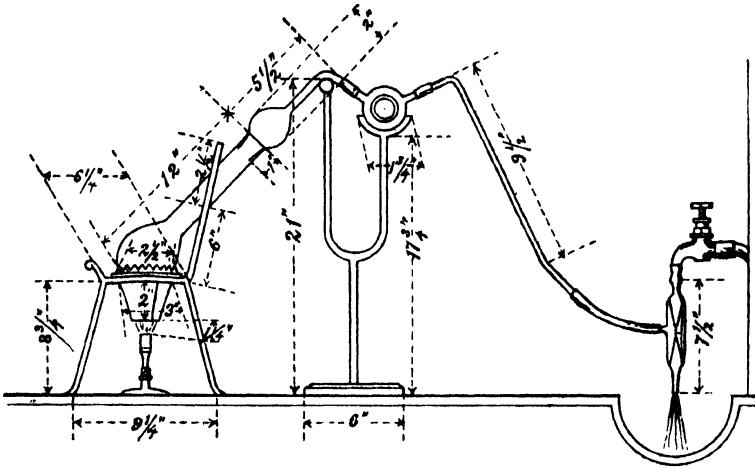

An Improved Form of Kjeldahl Apparatus.

a result of the use of this heat economizer a saving of time of digestion is also effected which in actual cases has worked out at as much as twenty-five per cent. (one hour as against one hour and twenty minutes).

The apparatus (Diagram I) is made by the Scientific Instrument Co., Allahabad, from whom it may be obtained. [C. M. HUTCHINSON.]

SPINELESS OPUNTIA IN WESTERN INDIA.*

ONE of the features of recent famines in the Bombay Deccan has been the establishment of Prickly Pear (*Opuntia*) as a regular emergency fodder, with which a continually increasing number of cattle are fed during the critical months before the following rains bring a crop of new grass. The methods of preparing and feeding the material were described in a bulletin by Professor Knight issued in 1920,¹ and these proved perfectly successful in the famine of 1920-21.

But it has been felt throughout that if spineless *Opuntia* could be grown so as to give a crop of reasonable size and weight, instead of the ordinary prickly pear, a very great saving would be effected, and a great deal of the difficulty in using the prickly pear would be eliminated. All the first attempts to grow the spineless varieties, however, seemed to indicate that they grow too slowly to be of very great value as an emergency fodder. In 1919, however, a definite experiment on a large scale was laid out near the Manjri farm in order to see what actual results could be secured in growing the crop.

Two varieties were planted, namely, those known as *Opuntia ficus-indica* and *Nopalea cochénillifera*. The former of these has very large joints eighteen inches in length by one foot in breadth when fully grown. It is, when mature, almost entirely spineless, and rubbing the joints with a piece of cloth is sufficient to remove

* The observations on which the present note is based have been almost entirely made by Mr. H. G. Mehta, Scientific Assistant, Manjri Farm.

¹ Knight, J. B. Prickly Pear as a Cattle Food. *Bull. No. 97, Bom. Dept. Agri., 1920.*

anything of the nature of a thorn. The second type is not entirely spineless and has much smaller joints, these being from twelve to fifteen inches long and about six inches broad. It may be at once stated that the second species proved unsatisfactory. It grew less vigorously, ripened more quickly, giving flowers and fruit, and its presence in the plantation has reduced the yield below what it would have been if the species first named had been exclusively used. The figures given for yield are hence somewhat lower than would be obtained if the work were recommenced.

The land on which the plantation was made was black cotton soil near the Manjri farm. It was of varying depth in the different lots planted. Some of the land was planted after ploughing and manuring with from four to twelve thousand pounds of farmyard manure per acre and some without ploughing and manuring. The actual plantings undertaken were as follows:—

1. The first was done on medium black cotton soil of average character in November 1919. Three waterings were given after planting so that the leaves planted might get well rooted. A few individual plants received an extra watering. As it did not seem to be flourishing, the plantation was cross ploughed and intercultured in July 1920, when a marked improvement rapidly took place.

This has been allowed to grow since that time with no attention beyond hoeing to remove weeds and protection from wild and domestic animals. In April to June 1922 it was cut for the first time and gave from seventy to one hundred joints per plant, or (including joints taken to plant a new area) 83,300 pounds per acre, in two and a half years. The whole of this plantation consisted of *Opuntia ficus-indica*.

2. The second planting took place in June and July 1920, and was cut at the same time as that previously considered. The land was of the same character, but perhaps a little lighter in texture. Only four thousand pounds of farmyard manure per acre were added before planting. The rainfall was very deficient in 1920, and hence hand irrigation was given, but only half the water was required that had been given in the previous case. The plants flourished from

the beginning, few gaps had to be filled, and within a fortnight new joints began to appear.

The later treatment was exactly the same as in the former case, but as the plot contained about twenty-five per cent. of *Nopalea cochenillifera* the yield was considerably lowered. It gave, however, when cut between April and June 1922 (that is to say about one year and nine months after planting), 42,480 pounds per acre. It was growing rapidly, however, at the time of cutting.

3. A third planting was made in lighter soil in October 1920. No manure was given, and one careful irrigation by hand after planting. A few weak plants received a second watering as they appeared to be likely to dry up. The joints from the plot first planted were used for making this extension. Difficulties from the rotting of the leaves from the bottom upward were found in the present case. Planting edgeways, so that the surface is exposed as little as possible to the sun, was carried on here, and proved very successful, the germination being very rapid. The later progress in growth was however very slow, compared with the first planting, which had been manured and watered more often after planting.

By April and May 1922 this planting had only grown from ten to twenty joints per plant, and so it was not cut. But it indicated that planting in the rains had been much more successful than when done after the rains were over, provided the rain received after planting is not excessive. Though the present plot was only three months younger than the last, the number of joints was only one-third of those in it.

4. The last planting was done in November 1921, in a soil full of lime nodules, and quite poor. In this case no general tillage was done, but pits were dug nine to twelve inches deep and about half the leaf was buried in the replaced earth and then the latter was pressed down hard. Thorough soaking with water was given. Progress was at first not rapid, and a good many gaps had to be filled in. Later progress has been, however, rapid and in May 1922, six months after planting, the plants had from two to five joints each and promised well.

It is clear, therefore, that, if carefully planted in well drained soil in the rainy season, a crop of over 40,000 pounds per acre may be expected in the hot weather of the second year, that is to say after a year and nine months. After this time the yield rapidly increases and six months' extra growth gave double the yield. We now have to see how rapidly the plantation renews itself after cutting and an account of this will be given next year.

The plantations have suffered, as already stated, from rotting of the leaves after planting. They have also been attacked by two fungi—*Diplodia* and *Pythium*—which proved of minor importance. The chief difficulty was, however, from damage by stray cattle and goats and from wild pigs, which necessitated the employment of a watchman. Fencing, in fact, is necessary, but ordinary prickly pear planted round the field will serve the purpose. Another trouble is the damage to the plants by wind when the plants get large, that is to say, when they carry from ninety to one hundred joints, which indicates the necessity of fairly frequent cutting.

The material produced from this plantation was used to feed cattle in the hot weather, as a partial substitute for ordinary fodders, with perfect success. [DEPARTMENT OF AGRICULTURE, BOMBAY.]

* * *

SECOND SALE OF SAHIWAL BULLS OF THE MILITARY DAIRY FARMS.

THE second of the annual sales of young Sahiwal bulls of the Military Farms was held at Ferozepore on the 26th March, 1923, when 14 bulls, bred on the Ferozepore and Lahore Military Dairy Farms, were offered, and also four bulls from the Punjab Government grantee cattle farm of Chowdhary Jahangir Khan, near Kacha Khuh. Prices realized were on the whole satisfactory, but the demand was satisfied before the whole of the lots had come to the hammer. Also it was unfortunate that several buyers had selected the same agent to bid on their behalf.

Interest centred mostly on four animals, namely, Lanark, Garry Owen, Vanadium and Abdelkadr. Lanark is a very deep-bodied

bull, strongly resembling his dam, Janet, who was one of the best constitutioned cows I have ever seen, though more of the type associated with the Sandal Bar (trans Ravi tract) than that of the Ganji Bar, which is commonly accepted by connoisseurs as the real "asal" Sahiwal. At her best Janet gave nearly 40 lb. daily and did 8,000 lb. in the year. This bull was bought for the Pusa herd at Rs. 725.

Garry Owen went for Rs. 525 to the Director of Agriculture, Nagpur, bringing less than his worth, probably because grey in colour. I do not know a purer Sahiwal than this bull and he descends from several generations of first class quality on both sides. His dam and grand dam are both over 6,000 lb. cows.

For Vanadium several people had sent buying orders, evidently finding his dam's 7,300 lb. attractive, but all were checked before Rs. 800, the upset price, was reached. Eventually he was taken by the Lyallpur Agricultural College at the reserve. He is full of Firststeel blood, hitherto the best of the several good strains found which make up the Ferozepore herd. His dam, Fanny, gives over 40 lb. daily at her best and is a cow of wonderful frame, development and constitution yet full of quality with it.

Abdelkadr, like Lanark, went to the Pusa herd, at Rs. 500. A nice red bull likely to give more size to his progeny than the average Sahiwal.

Of the four bulls offered by Chowdhary Jehangir Khan, only three were sold and the highest price was a shade over Rs. 200 only. Two of them were really nice bulls and were taken for the Military Farms as their dams were known to me, but their milk yields have not been recorded and the public were shy. Two of our own bulls were passed in as all buyers were satisfied.

I think there is ground for believing that this sale will now be successful as an annual event, but much will depend on the official interest of Provincial Departments of Agriculture. We have received representations that the date is too late in the year and also that some buyers would like to have older bulls offered, to both of which we hope to pay heed next year.

Below are given a few illustrations of some of the noted individuals (Plate XIII) of the herd :—

Fig. 1. Firsteel, now 14 years old and still vigorous. His lines are very good indeed, in particular, he has little if any of the defect of conformation—the steep falling away behind the pin bones—which is so common in Indian cattle and is so much against good udder development.

Fig. 2. Fanny, his eldest daughter, over 7,000 lb. in 300 days. She is a beautiful red with a white patch in each flank.

Fig. 3. Felicity II, another daughter of Firsteel—a poor picture but included as this is believed to be the heaviest milking Sahiwal cow known—has given over 9,000 lb. in 300 days.

Figs. 4, 5 and 6. Lucy, Carmen, and Felicia are three young cows sired by another successful bull—Fiddle. Lucy's daily yield is 33 lb., Carmen's 36 lb., Felicia's 41 lb. [J. MATSON.]

* * *

TRIALS WITH TURNIPS, SWEDES AND MANGOLD.

MESSRS. EDWARD WEBB & SONS, of Stourbridge, England, last cold weather, supplied to the Agricultural Research Institute at Pusa for trial seeds of various crops which included turnips, swedes and mangold. As the results of the trials with these root crops seem to be promising, they are published for the information of the readers of this Journal.

The soil at Pusa is a deep alluvium easily worked and retentive of moisture. The field in which the trials were made received four cultivations and a heavy dressing (600 md. per acre) of farmyard manure before sowing. The seed was sown on ridges on 16th and 17th October, 1922, at the rate of about 4 to 6 lb. per acre. The plants were thinned out to one foot apart after they had formed six leaves. Irrigation was given every 15 days and the crop took about three months to come to maturity. The crop was a good



Fig. 1. Firsteel.

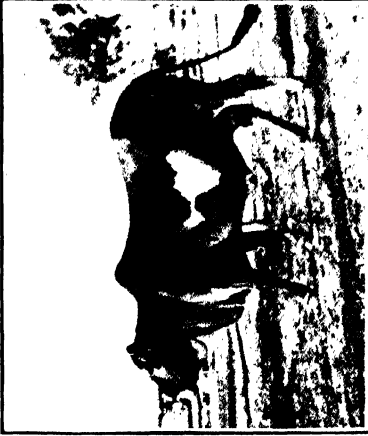

Fig. 2. Fanny.



Fig. 3. Felicity II.



Fig. 4. Lucy.



Fig. 5. Carmen.



Fig. 6. Felicia.

SAHIWAL CATTLE OF THE MILITARY DAIRY FARMS.



A COLLECTION OF WEBB'S BEEF HEART TURNIPS.

one and some varieties gave very high yields, as will be seen from the following table :—

Name of variety				Yield per acre in maunds of 82 lb.
<i>Turnips</i>				
1.	Webb's Green Top Scotch	604
2.	.. Beef Heart	666
3.	.. Invincible	671
4.	.. Yellow Tankard	723
5.	.. White Stone, early	741
6.	.. Selected Green Globe	817
7.	.. " White "	849
<i>Suedes</i>				
1.	Webb's New Masterpiece	787
2.	.. New Arctic	965
3.	.. New Buffalo	1,153
<i>Mangold</i>				
1.	Webb's Mammoth Long Red	515
2.	.. Red Intermediate	547
3.	.. New Band Golden Intermediate	607
4.	.. Champion Yellow Globe	684
5.	.. Yellow Intermediate	688

* * *

[EDITOR.]

RHINOCEROS BEETLE.

ANENT the note entitled "Rhinceros Beetle" (*Oryctes rhinceros*), page 183, March 1923 issue of this *Journal*, the following experiment carried on by me at the Sugarcane Breeding Station, Coimbatore, might be of some interest. This station has a long belt of young coconut trees about eight years old, and damage from Rhinceros Beetle is considerable. Before June 1922, the beetles used to be extracted from inside the crowns by the usual hooked needle. This was found to be very expensive, costing as much as four annas per day in the shape of labour, the number of beetles caught

being between thirty and forty a day and about ten trees had to be replaced on account of death due to beetle attack. In June 1922, the method of sanding the leaf-sheath bases was tried. Bases of leaf-sheaths from the top downwards—about twelve in number—were filled with river sand in every alternate palm, the palms in between being left as controls. Occasionally, the supply of sand had to be replenished as the trees grew. The results are given in the table below :—

Period of collection	NUMBER OF BEETLES COLLECTED	
	From treated palms	From untreated palms
25th–30th June, 1922 ..	8	23
July, whole month ..	53	106
August, whole month ..	73	152
September, whole month ..	112	290
October, 1st–4th ..	15	22

The diminution in beetle attack with sanding is obvious.
[U. VITTAL RAO.]

REPORT OF THE WATER-HYACINTH COMMITTEE, BENGAL.

THE Government of Bengal, Department of Agriculture and Industries, have published the following resolution, No. 41 T.—A. I., dated the 16th April, 1923 :—

In pursuance of a resolution carried at a meeting of the Bengal Legislative Council, the Government of Bengal, in June 1921, appointed a committee to enquire into the spread of the water-hyacinth in Bengal, and to suggest measures for its eradication. The committee have submitted a report in which they have not been able to come to a unanimous conclusion on the important question of the measures to be taken for the eradication of the pest, but they have unanimously recommended that an investigation be undertaken in the first instance into the life-history of the water-hyacinth and its mode of propagation, and later on into practical

methods of checking its growth and the possibility of its economic utilization. Pending further investigation, the committee recommend the encouragement of the collection of the hyacinth and its destruction by fire as the only means of immediate amelioration of the situation created by the pest. They are also of opinion that concerted action, which should be secured by legislation, is necessary. The Government of Bengal (Ministry of Agriculture and Public Works) regret that the committee's lack of unanimity renders it very difficult to decide on the most desirable action to be taken. They agree with the committee that concerted action is necessary for the eradication of the pest and that, until some chemical method of effectively combating it is evolved, its collection and destruction by fire is the most practical way of dealing with it. They will also consider the question of legislation, and they are enquiring from the Government of Burma about the results obtained from the operation of the Burma Water-Hyacinth Act, 1917 (I of 1917). The Government of Assam are also being invited to co-operate with this Government in any measures, legislative or experimental, which it may be decided to adopt. The Hon'ble Minister is also impressed with the necessity for the whole-hearted co-operation of the public in any measure of mechanical eradication of the water-hyacinth which may serve even as a temporary paliative. The local bodies and municipalities and the Eastern Bengal and Assam Bengal Railway authorities have in the past interested themselves in measures for dealing with the pest, but owing to the lack of concerted action their efforts have not so far been productive of encouraging results. The Government of Bengal (Ministry of Agriculture and Public Works) hope to win their co-operation in such measures as they may now take.

The committee were not unanimous about the efficacy of the spray, demonstrations of which were given by its inventor, Mr. T. S. Griffiths. Sir Jagadish Chandra Bose and some members of the committee hold that the demonstrations were inconclusive. The experiments conducted on a small scale at Dacca under the supervision of the Imperial Mycologist and Economic Botanist to the Government of Bengal do, however, afford grounds for the belief

that the fluid used by Mr. Griffiths, although harmless to human beings and animals, results on application in the destruction of the water-hyacinth.

Steps have accordingly been taken to communicate with Mr. Griffiths to ascertain the terms on which he would be prepared to undertake an extensive demonstration of the efficacy of his spray during the current year.

The minister in charge desires to convey his thanks to the President and members of the committee for the trouble and care with which they investigated the question at so much personal inconvenience and sacrifice.

* * *

COTTON GROWING IN BRAZIL.

ATTENTION was drawn in a recent issue of this Journal¹ to the exhaustive report issued by Mr. Pearse, Secretary, International Federation of Master Cotton Spinners' and Manufacturers' Association, on the prospects of Brazil becoming one of the great cotton-producing countries of the world. Mr. Pearse shows that not only does Brazil already produce large quantities of excellent cotton which, if properly handled, would be a valuable addition to the world's supply but that the yields obtained are extremely high and that the prospects of further expansion are most favourable.

An International Cotton Conference was organized at Rio de Janeiro by the "Sociedade Nacional de Agricultura" in October 1922 which was well attended. The full report is not yet available, but the resolutions passed have now been published and those which appear to be of general interest are given below. [B. C. BURT.]

RESOLUTIONS OF THE INTERNATIONAL COTTON CONFERENCE HELD IN RIO DE JANEIRO, OCTOBER 15TH TO 20TH, 1922, UNDER THE AUSPICES OF THE GOVERNMENT OF THE BRAZILIAN REPUBLIC.

(1) This International Cotton Conference, representing 20 nations, after due consideration of the world's shortage of cotton,

¹ *Agri. Jour. India*, Vol. XVII, Part V, p. 542.

which has a tendency to continue or to become more pronounced, expresses the unanimous opinion, that all those countries in the world which possess the essential conditions for cotton growing, should employ all the means in their power to initiate and develop cotton cultivation. This Congress is convinced of extremely remunerative prospects awaiting cotton cultivation under rational conditions.

This Congress expresses the opinion that Brazil, which already supplies all the cotton requirements for its internal consumption, should prepare to take her place in the large markets of the world, by becoming one of the constant and regular suppliers of cotton.

This International Cotton Conference recommends that greater attention be given to the teaching of cotton growing in agricultural schools and other establishments of elementary, intermediate and higher education, as from the instruction of the masses depends largely the improvement and development of cotton growing.

This Conference recommends the organization of official stations for experimental, co-operative and demonstration purposes, with the object of improving the cotton and the method of its cultivation, bearing especially in mind the study of local varieties already existing in Brazil.

This International Cotton Conference considers the establishment of farms for the production of selected seeds of fundamental importance. In every State there should be one such seed farm for each of the various cotton zones.

- (a) Such farms, which should become self-supporting, are to be managed in such a way, that the relative profit resulting from the cultivation of any variety can easily be determined.
- (b) The seeds from such farms are to be sold at the current market price to those farmers who undertake to plant no other cotton seed on their lands.

This Conference recommends, in view of the fact that American cotton, $1\frac{1}{3}$ to $1\frac{3}{8}$ th of an inch (28 to 30 mm.) in length, is most in demand in the cotton markets of the world, that

this kind of cotton should be increasingly grown, without interfering, however, with the cultivation of longer staple cotton in those parts of Brazil which possess the necessary climatic and soil conditions.

The use of modern agricultural implements is recommended and each State should ascertain, by experimentation, which implements are most suited for its conditions.

Facilities for the purchase of agricultural implements of the above type should be granted by State and Federal Governments.

The agricultural establishments of the State and Federal Governments are recommended to determine by experiment which fertilizers are best adapted to their respective districts.

The Governments should control the trade in fertilizers by special laws as regards their origin, composition and comparative agricultural value.

Facilities for the purchase of fertilizers should be granted by the State and Federal Governments.

This Congress is of opinion, that generally cotton picking and warehousing in Brazil are performed in a most careless manner, which accounts for the fact that Brazilian cottons are not able to command in the world's markets the best prices.

Means should be taken that the grower of clean picked and well stored cotton receives its commensurate value.

That harmful insects, such as the ring worm ("broca"), *Gasterocercodes gossypii*, the pink boll-worm ("lagarta rosada") *Gelechia gossypiella*, and the cotton worm ("curuquerê") *Alabama argillacea*, cause considerable damage to the cultivation of cotton and require therefore intensive propaganda work of the methods known for their extermination. These pests should be combated with special care by the public and private authorities of Brazil and by all cotton-growing countries. All the most practical methods should be immediately applied for this purpose.

That, as far as Brazil is concerned, the action undertaken by the cotton-producing States which have introduced the Cotton Defence Service, is considered sufficiently efficacious; this Cotton Defence Service should, however, become general in all the remaining States of the Federation.

That, as a means of defence against insects in general, preference should be given to early maturing cotton varieties and these should be planted in accordance with the local meteorological conditions.

In combating the pink boll-worm in particular, and in a general way all insects harmful to cotton in Brazil, the following measures are recommended :

- (a) Each farmer should arrange his new fields in such a way that they are at least two kilometres apart from the old ones or where cotton was formerly cultivated.
- (b) All the vegetable growth of old cotton fields should be burned. Such land should be used for other crops or pasture and cotton should not again be planted in the same field except after a lapse of a minimum period of three years.
- (c) The cotton pickers should carry with them during the picking process two receptacles, one for sound cotton and the other for infected bolls; these latter should be burnt at the side of the field.
- (d) The farmer should immerse for two minutes into hot water the seed; the temperature to be not less than 55° and not more than 60° C. This is recommended as a sure remedy for the destruction of the insects.
- (e) Annual varieties should be planted in districts suitable for their cultivation; all the plants, stalks, etc., should be torn out after picking and they should be burnt at the side of the field in order to destroy all possible sources of infection.
- (f) In case of perennial cottons, after pruning severely the stem, the branches and remnants which have thus been cut off should be burnt to ashes.

The establishment of the necessary installation to enable the strict compliance with the requirements of a certificate of seed disinfection, so that in case of need, the transportation of seed through the country, by any means of communication without this certificate, be forbidden, whatever be the destination of the seed.

The study of the most practical, efficacious and economical means of disinfecting cotton carried in the state of seed cotton on the various railway lines of the country.

Co-operative societies should be formed amongst the small farmers and ginneries of cotton with the object of getting the seed disinfected as soon as possible and the seed cotton properly stored ; seed awaiting disinfection should be stored in warehouses whose openings are well protected by wire netting.

That they insist upon the introduction of sanitary certificates of international validity, for all vegetable matter. Such certificates are to be signed by the official of agricultural defence organization.

That the restriction of imports and exports provided for by the laws of the various countries be enforced.

That efforts be made to protect against the entrance in their territory of the two worst plagues, viz., the pink boll-worm (*Lagarta rosada*) and the boll-weevil (*Gorgulho da Maçã*) by limiting the importation of cotton products to certain defined ports, at which apparatus for the efficient disinfection of such raw materials should be installed.

In each cotton State a permanent Cotton Committee be appointed, composed of an Executive Council, constituted by the highest officials of the Federal Cotton Service, also of six members elected from the commerce, industry and cultivators of cotton, and of as many members or commissions as correspond to the municipalities existing in each State interested in cotton.

- (a) The Governments should recognize these committees as a consulting body for the study of all cotton questions.
- (b) These committees should combine in a federation, which should be represented in the National Agricultural Society for the defence of all cotton interests in accordance with its decisions.

As a means of dissemination of practical instruction the Federal Congress should vote a special credit through subsidy, to cover ten years, to those organizations which undertake the establishment of elementary technical schools for the purpose of educating

young men to enable them to become farm managers. The lines on which such schools are to be worked will be defined jointly by the above committee and the Cotton Service.

- (a) Such schools will be established in the proper cotton zones, on the lines of a model farm, essentially of a practical nature: their number will depend on the concentration of the largest population; at least at every 100 kilometre such a school should be started, and each school should maintain ten students free of charge.
- (b) The right to a free studentship (with board) will be decided by special judges, composed of technical experts of the Cotton Service, of other schools and of the above committee, so as to guarantee the best supervision and impartiality.

In order to encourage the solution of the problem of seed disinfection, and recognizing that disinfection of the seed forms the basis for the reduction of damage caused by the "pink boll-worm," a money reward should be given to any one who will show, within six months from the setting-up of the competition, the best means of overcoming the pest; such remedy must answer the particular conditions of the north-eastern and other zones of Brazil. The prize will be awarded to the best paper showing how the work is to be carried out and how an apparatus capable of dealing daily with 30 tons of seed is to be constructed.

Extensive trials with the apparatus will have to be carried on in the various districts before awarding the prize and the Cotton Service is to undertake the free transportation of the apparatus from one district to another.

All means should be used to have cotton properly picked, that not only should the various types be kept apart, but also all the usual adhering remnants of foreign matter should be eliminated.

Under the present conditions of mixture of various cottons the use of saw-gins is advisable; it is, however, necessary to attend to the saws properly and regularly and the speed of the machines

should be watched, in order to avoid damage to the fibre. It is indispensable that all gins be provided with feeders, cleaners and condensers. These requirements should be superintended by officials of the Cotton Service, or others specially appointed for this purpose, who will not only inspect the machinery, but also undertake the careful sharpening of the saws, free of charge.

(a) The ideal treatment of long staple cotton is by means of roller gins and the Government should foster by all means at its disposal the introduction of such roller gins.

(b) As the manufacturing of cotton machinery is of national interest, the Federal Government should encourage this industry in the country by means of awards or special favours which should, however, not prevent the importation of similar machinery.

Frauds committed in the packing of cotton, such as adding linters, foreign substances, seed, etc., should be strictly punished by means of fines or other legal measures to be enforced by the Cotton Service.

The authority be given for prohibiting through the Ministry of Agriculture frauds in connection with the ginning of cotton, for which purpose a special ordinance should be issued, so that the mixing of interior types with long staple cotton be forbidden and the denomination of the cotton, according to the district of origin, be solely admissible. For this purpose it will be necessary that in each ginning factory the bales be marked by means of marks, registered in the respective agency of the Federal Cotton Service.

The supervision of the installation and working of the gins, in order to avoid the irregularity in the speed of the gins to the detriment of the fibre and to demonstrate the necessity for frequently sharpening the saws.

Each ginning factory shall keep a book, in which all the lots ginned are registered, with a view to enabling the building up of statistics on the model of the Bureau of the Census, Washington, D. C., U. S. A.

The authorization to prohibit through the Ministry of Agriculture frauds in connection with cotton seed oil mills, the filling of tins and general packing for sale of this product; infringements should be punishable by fines of from 200 \$000 to 1.000 \$000.

Classification of cotton.

All Brazilian cottons shall be graded in types corresponding to those of Liverpool, viz. :—

Good ordinary American	—(“ Soffrivel ”)
Low middling	—(“ Commum ”)
Middling	—(“ Bom ”)
Good middling	—(“ Superior ”)
Fully good middling	—(“ Excellente ”)

Seed selection should be carefully undertaken and certain cotton districts should only plant special seeds with a view to avoiding, in this way, a mixture of the different varieties. As long as cotton is not of a uniform quality, the consumer can only pay the price corresponding to the lowest quality in the sample.

The characteristics of cotton which enable the consumer to obtain the best results may be enumerated as follows :—

- (a) fibres equal in length,
- (b) ripe cotton,
- (c) grade (colour, absence of leaves and foreign substances) uniform throughout the lot,
- (d) absence of dead cotton, seed and foreign matter.

The English cotton merchants and spinners, being of opinion that the low value of Brazilian cottons is due to their bad treatment in unsuitable gins—which represents a heavy loss to Brazil and her farmers—it is necessary to remedy this defect and to institute a more perfect supervision of the cotton-ginning factories.

Several members of this Commission have had occasion to examine Brazilian cottons of excellent quality, but considerably spoilt by the bad ginning, thus causing their prices to be as much as 1*d.* per lb. below those of similar cottons, properly ginned.

The absence of an official classification constitutes one of the causes which render the cotton trade difficult as to relations between sellers and buyers, within Brazil and abroad, and therefore

it is a matter of urgency that the Public Legislative Authorities, in accordance with Rule 5, Art. 34 of the Federal Constitution, should act with the object of having standard official types established, aiming, at the same time, at an improvement of the ginning and the quality of the fibre, and that national and international commercial relations be brought about in accordance with usages and traditions of the various markets.

For the careful execution of such steps there should be established, in the principal markets of Brazil, exchanges which deal with cotton and its by-products; such exchanges to be on a uniform basis in accordance with the Federal laws and regulations.

For the purpose of fixing the official cotton types, a committee should be appointed to be composed of one representative of each of the principal national and foreign exchanges, interested in cotton and of representative of the Brazilian Cotton States, of the National Agricultural Society and of the Federal Cotton Service and to this committee the work of fixing the standard types should be allotted.

This Committee will be domiciled at Pernambuco city and at Rio de Janeiro and will start work during this season, making use of the material relating to cotton varieties of the different cotton producing States; the fixing of the definite types to be made only for each season after verification of the types originally established.

As a preliminary step, to remain in force until the organization of definite types, Brazilian cottons should at least be divided into two classes, the first being the herbaceous cottons of the Upland American type and those known in the north-east of Brazil as "Matta," the second being those called generally "Sertão," which includes the "Quebradinho," "Verdão" or "Riquiza," and "Mocó." Each of these will be subdivided into five standard types in accordance with the usual Liverpool classification.

The formation of the standard types will have as basis the characteristics of cleanliness of the cotton, its colour, state of

maturity of the fibre and the quantity of ginning. The denomination of these standard types, relative to each class, will be as follows:—

An average type, called “ Bom,” two grades above this respectively, “ Superior ” and “ Excellente ; ” two grades below, “ Commum ” and “ Soffrivel.”

The Commission charged with the making-up of the standard types will have to establish definitely the names of these types in Portuguese and English, and if it thinks fit, it may create intermediary types.

* * *

COTTON RESEARCH.

THROUGH the courtesy of the British Cotton Industry Research Association, the Secretary of the Indian Central Cotton Committee has sent the following abstract for publication:—

Used faster than grown.

World cotton production 16,000,000 bales, consumption 20,000,000 bales.

The Department of Commerce has now completed, through its domestic and foreign staff, the third world cotton summary during the last year. It shows that on July 31, 1922, the world stock of American cotton was 5,123,000 bales and world stocks of all kinds of cotton (including American) were 9,536,000 bales. Adding this season's production of 9,964,000 bales of American cotton and 17,664,000 bales of all kinds, the total supply for the season 1922-23 is 15,087,000 bales of American and 27,200,000 bales of all kinds. This is less by about 2,250,000 bales of American and the same amount of all kinds of cotton than the supply for 1921-22. From this total supply subtract the estimated consumption for the year 1922-23 of 12,312,000 bales of American and 20,579,000 of all kinds of cotton and the indicated carry over on next August 1, 1923, is only 2,750,000 bales of American and 6,500,000 of all kinds. That is, the stocks of American cotton will have diminished over 6,500,000 bales and stocks of all kinds, over 8,000,000 bales within only two years, and will have reached an abnormally low total.

The following table shows the world's supply and estimated distribution of American and all kinds of cotton (including American for the years ended July 31, 1922 and 1923) :—

World's supply and distribution of cotton, 1921-22, with estimates for 1922-23.

	American	All kinds
	in thousands of bales	
Stocks, Aug. 1, 1921	9,351	14,752
Production (commercial cotton *), 1921	7,954	14,741
Total supply 1921-22	17,305	29,493
Consumption, 1921-22	12,293	20,047
Stocks, July 31, 1922 †	5,123	9,536
Production (commercial cotton) 1922 ‡	9,964	17,664
Total supply 1922-23	15,087	27,200
Consumption, 1922-23 (estimate)	12,312	20,579
Apparent stocks, July 31, 1923 (by deduction)	2,775	6,621

* This represents actual crops except in China and India, where the cotton that enters into household consumption is excluded from the total as being of little commercial interest.

† Total compiled from actual stocks reported in different parts of the world. The apparent stocks, arrived at by deducting the consumption from the total supply, were 5,012,000 bales of American and 9,446,000 bales of all kinds of cotton. For the items making up the total stocks reported on July 31, 1922, see *Commerce Reports* for November 13, 1922.

‡ Subject to revision when the final ginning returns are received.

Decrease in carry over.

The trend of world supplies is shown more clearly by taking from the foregoing table the estimated world carry over for the three years :—

World stocks of cotton, August 1, 1921, 1922 and 1923.

Date	American	All kinds
August 1, 1921 ..	9,351,000	14,752,000
August 1, 1922 ..	5,123,000	9,536,000
August 1, 1923 ..	2,775,000 *	6,651,000 *

Estimated.

Production and consumption.

The following figures relating to the world cotton production and estimated cotton consumption by countries for the 1921-22 and 1922-23 seasons were compiled by the Bureau of Foreign and Domestic Commerce, Department of Commerce, in co-operation with the Bureau of the Census of the same department and the Bureau of Agricultural Economics, Department of Agriculture. All quantities are shown in bales of 478 pounds net weight. The production and consumption of linters have not been included in the figures.

World's cotton production for 1921-22 and 1922-23, and consumption for 1922-23.

Countries	PRODUCTION		CONSUMPTION	
	1921-22 Bales	1922-23 Bales	1922-23 American Bales	1922-23 All kinds Bales
United States	7,954,000	9,964,000*	6,150,000	6,400,000
EUROPE :—				
United Kingdom	2,100,000	3,100,000
Continent	†	†	3,167,000	4,523,000
British India	3,360,000	3,750,000	20,000	1,950,000
Egypt	837,000	1,050,000	†
Japan	†	†	600,000	2,500,000
China	1,175,000	1,500,000	†	†
Brazil	612,000	545,000	†
All other countries	803,000	855,000	275,000	2,106,000
Total	14,741,000	17,664,000	12,312,000	20,579,000

* Subject to revision when final ginning returns are received.

† Included in all other countries.

Estimated consumption, 1922-23.

The world's consumption of cotton during the years ended July 31, 1921, 1922, and estimated consumption for the year ending July 31, 1923, are shown by principal consuming countries in the following table :—

World's consumption of cotton, 1920-21, 1921-22, and estimated consumption in 1922-23.

Countries	IN THOUSANDS OF BALES		
	1920-21	1921-22	1922-23]
United States ..	4,906	5,904	6,400
EUROPE—			
United Kingdom ..	2,134	2,948	3,100
Continent ..	4,602	4,823	4,523
India	1,925	1,947	1,950
Japan	1,883	2,275	2,500
All other countries ..	1,464	2,150	2,106
Total .	16,914	20,047	20,579

World production.

The following table shows the world production and consumption of cotton from 1908-09 to 1922-23 (estimated) and European consumption for the same years. It will be seen that even with the increase in the last two years European consumption is only 70 per cent. of the pre-war average, while world consumption is almost back to normal.

World's cotton production and consumption for the years indicated.
(In bales of 478 pounds lint.)

Years	IN THOUSANDS OF BALES		
	World production	World consumption	European consumption
1908-09	20,604	20,289	10,968
1909-10	16,988	19,164	10,295
1910-11	18,856	19,888	11,040
1911-12	22,247	21,534	11,998
1912-13	21,550	22,533	12,117
1913-14	22,612	22,199	12,029
1914-15	24,861	20,670	10,606
1915-16	18,461	21,978	10,878
1916-17	18,924	21,108	9,044
1917-18	18,141	18,515	6,621
1918-19	18,765	16,705	5,962
1919-20	20,219	19,300	7,699
1920-21	19,675	16,914	6,736
1921-22	14,741	20,047	7,771
1922-23	17,664	20,579	7,623
Average, 1908-09 to 1914-15	21,102
Average, 1908-09 to 1916-17	21,040	10,996
Average, 1915-16 to 1920-21	19,031
Average, 1917-18 to 1920-21	17,860	6,755
Average, 1921-22 and 1922-23	16,202	20,313	7,697

Method of estimating.

The consumption estimates covering 1922-23 are based upon reports submitted by Government representatives abroad, which gave the consumption in each country reported on, for the first four

months of the season, August 1 to December 1, 1922. From these consumption figures for the first four months, estimates have been made for the entire year. Due consideration has been given to general economic conditions, as well as to special conditions affecting the textile industry in each country ; and if some unforeseen change does not occur, it is believed that the totals given are approximately correct. Allowance has already been made for decreases in consumption in many of the countries during the remaining months of the season ; but if the price of cotton should go so high as to cause a general curtailment of mill consumption, the quantities consumed for the remainder of the cotton year might fall off so sharply that the above totals would not be reached. [*Textile World*, Vol. LXIII, No. 7, February 17, 1923.]

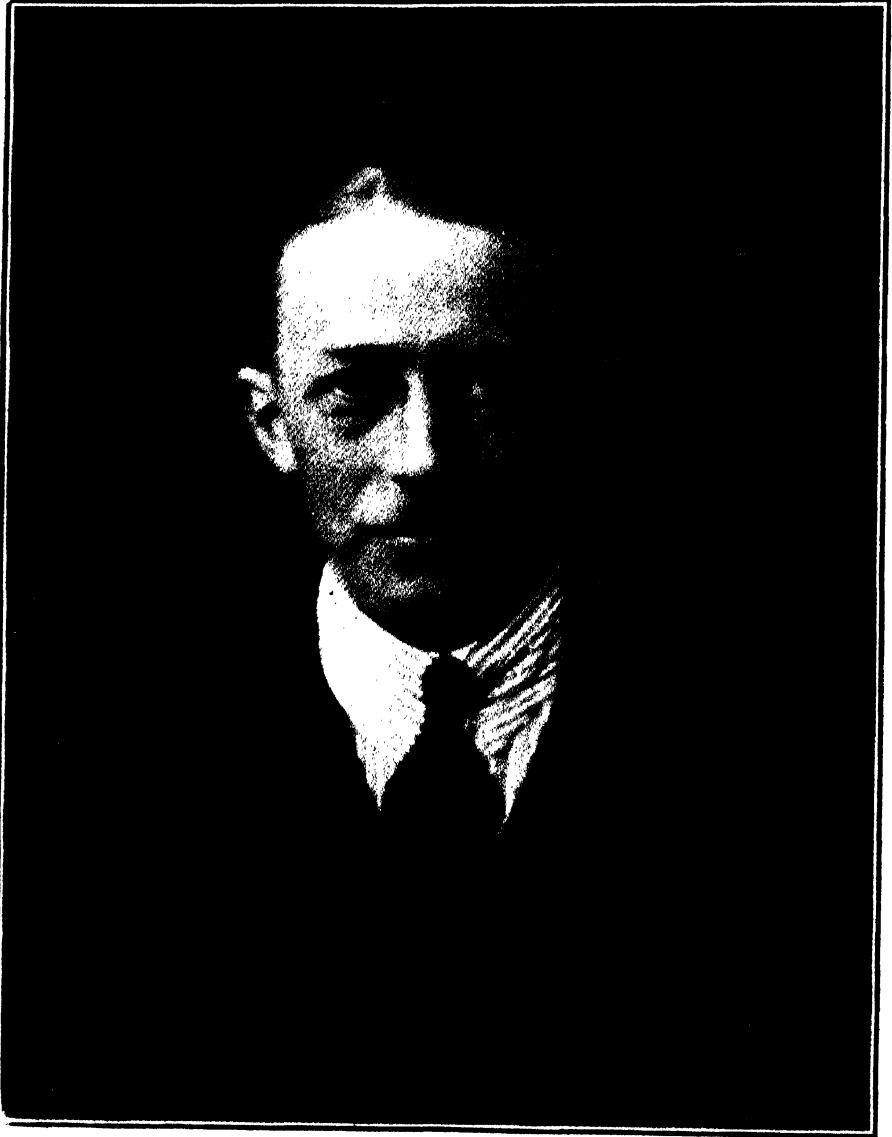

EDWARD BALLARD, B.A., F.E.S.

PERSONAL NOTES, APPOINTMENTS AND TRANSFERS, MEETINGS AND CONFERENCES, ETC.

WE regret to notice an announcement in the *Fort St. George Gazette* to the effect that Mr. Edward Ballard, Government Entomologist in Madras, has been permitted to retire from the Indian Agricultural Service on the expiry of the leave granted to him. After graduating from Cambridge, Mr. Ballard went out to Nyasaland as Entomologist and worked there for about three years until his appointment to Madras in January 1914. In August 1915 he took leave and joined up at Home, serving throughout the remainder of the War in the Artillery, in which he attained the rank of Captain, returning to Madras in May 1919. During his service in India, Mr. Ballard showed himself to be a keen and competent worker, especially interested in the insect pests of cereals and cotton, and his early retirement creates a distinct gap in the scanty list of entomological investigators in India. He has obtained an entomological post at Bristol, where we hope that he has many more years of useful work before him.



HIS MAJESTY THE KING-EMPEROR'S BIRTHDAY HONOURS LIST contains the following names which will be of interest to the Agricultural Department :—

K.C.S.I. THE HONOURABLE RAO BAHADUR BAYYA
NARASIMHESWARA SARMA, Member of the Executive
Council of the Governor-General.

C.S.I. JOHN HULLAH, Esq., Indian Civil Service, late
Secretary to the Government of India. Department of
Revenue and Agriculture.

Rai Sahib. LALA JAI CHAND LUTHRA, M.Sc., Assistant Professor
of Botany and Superintendent, Boarding House,
Agricultural College, Lyallpur, Punjab.

Rai Sahib. BABU SURENDRA NATH SIL, Personal Assistant to the Director of Agriculture, Bihar and Orissa.

Rai Sahib. LALA CHARAN DAS KURRA, Assistant, Department of Revenue and Agriculture, Government of India.

* * *

MR. S. MILLIGAN, M.A., B.Sc., Agricultural Adviser to the Government of India and Director, Agricultural Research Institute, Pusa, has been granted leave on average pay for 5 months and 14 days with effect from 1st June, 1923.

* * *

MR. D. CLOUSTON, M.A., D.Sc., C.I.E., Director of Agriculture, Central Provinces, has been appointed to officiate as Agricultural Adviser to the Government of India and Director of the Agricultural Research Institute, Pusa, with effect from the 1st June, 1923, *vice* Mr. S. Milligan, on leave.

* * *

MR. F. J. WARTH, M.Sc., Physiological Chemist, Pusa, has been granted an extension of leave on average pay for one month.

* * *

MR. B. C. BURT, B.Sc., M.B.E., has been appointed Secretary of the Indian Central Cotton Committee constituted under Section 4 of the Indian Cotton Cess Act, 1923 (XIV of 1923).

* * *

RAO BAHADUR K. RANGA ACHARIYAR AVERGAL, M.A., Government Lecturing Botanist, Madras, has been granted an extension of leave on average pay for four months.

* * *

MR. P. H. RAMA REDDI GARU, Deputy Director, III Circle, has been appointed to act as Professor of Agriculture and Superintendent of the Central Farm, *vice* Mr. D. Balakrishna Murti Garu, on leave.

MR. A. V. THIRU MURUGANADAM PILLAI, Assistant Director of Agriculture, IV Circle, has been appointed to act as Deputy Director of Agriculture, III Circle, *vice* Mr. Rama Reddi Garu, on other duties.

* * *

DR. R. V. NORRIS, Government Agricultural Chemist, has been granted leave on average pay for four months and leave on half average pay for fifteen months and ten days with effect from the 1st July, 1923, Mr. B. Viswanath acting.

* * *

MR. D. BALAKRISHNA MURTI GARU, Acting Professor of Agriculture at the Agricultural College, Coimbatore, has, on return from leave, been appointed to act as Professor of Agriculture and Superintendent of Central Farm, Coimbatore.

* * *

MR. KALKA PRASAD SHRIVASTAV, Extra Assistant Director of Agriculture, has been appointed to officiate as Mycologist to Government, Central Provinces, in addition to his own duties, during the absence on leave of Mr. J. F. Dastur.

* * *

MR. R. F. STIRLING, F.R.C.V.S., I.C.V.D., has been confirmed as Second Superintendent, Civil Veterinary Department, Central Provinces, with effect from the 6th April, 1923.

* * *

MR. MAYA DAS, Professor of Agriculture, Agricultural College, Cawnpore, has been appointed to officiate as Principal of the College, with effect from the 8th March, 1923, *vice* Dr. H. E. Annett, on leave.

* * *

MR. D. P. JOHNSTON, Deputy Director of Agriculture, Lyallpur, Punjab, has been granted leave on average pay for five months from the 21st May, 1923.

CAPTAIN E. SEWELL, M.R.C.V.S., M.C., Professor of Hygiene, Punjab Veterinary College, Lahore, has been granted leave on average pay for 2 months with effect from the 1st May, 1923, combined with the College vacation from the 1st July to 30th September, 1923.

* * *

CAPTAIN U. W. F. WALKER, Professor of Surgery, Punjab Veterinary College, Lahore, has been appointed to officiate as Professor of Hygiene in addition to his own duties with effect from the 1st May, 1923.

* * *

ON completion of his training, Mr. T. J. Egan has been appointed Assistant Superintendent, Government Cattle Farm, Hissar, with effect from the 6th April, 1923.

* * *

THE services of Mr. O. T. Faulkner, Deputy Director of Agriculture, Punjab, have been transferred permanently to Nigerian Service with effect from the 15th June, 1921.

* * *

MR. W. L. SCOTT, I.C.S., has been appointed as Director of Land Records and Agriculture, Inspector-General of Registration, Registrar-General of Births, Deaths and Marriages and Superintendent of Stamps, Assam, *vice* Mr. J. Hezlett, I.C.S., appointed to act as Commissioner, Surma Valley and Hill Division.

Reviews

The Co-operative Movement in India.—By PANCHANANDAS MUKHERJI, M.A., F.R.E.S. Third Edition ; 1923. (Calcutta : Thacker, Spink & Co.)

SINCE we reviewed the second edition of this book in our issue of July 1917, Co-operation in India has made great strides ; the credit side has expanded to a degree which it is difficult to realize from annual reports, while there has been a continuous series of experiments in the application of co-operative principles to new problems. The result is that a book which attempts to deal with a general description of the movement must undergo changes as great as the movement itself ; and we congratulate Professor Mukherji on the success with which he has fulfilled his self-imposed responsibility. The book before us is a careful, accurate and complete compilation of information relating to the present state of Co-operation in the different provinces of India. A comparison of its contents with those of the previous edition provides some idea of the changes that have taken place, the better appreciation of the importance of Co-operation to improved agriculture, the growth of co-operative stores and the better organization of co-operative finance ; while a detailed examination of the chapters discloses the amount of literature on the subject that has appeared in the last six years. On the whole Professor Mukherji adopts an impartial attitude towards controversial questions, quoting the views of differing advocates, and refraining from delivering what would have to be, in most cases, an indecisive judgment. But, occasionally, he takes sides and not always with success. On the subject of the employment of reserve funds in primary credit societies, for instance, he rejects without discussion the view of the Maclagan Committee that these may be utilized in the business of the institutions to which they belong. He objects to village societies becoming independent

units managing their own affairs without support from central bodies. In short, he appears to disapprove of the share system which is becoming more and more popular and which makes for financial soundness. In his paragraph on this subject, he appears to place the importance of the organization above the well-being of the members which the organization is designed to promote, an error which should have been impossible after the fiasco in the Central Provinces and the practical collapse in Agra and Oudh.

On the moral effects of Co-operation, Professor Mukherji has much of interest to say, but he seems to lay too little stress on the grand moral effect of a combined effort by a body of men to relieve themselves of the burden of life-long debt by mutual help. That there are many minor results of co-operation in promoting sobriety, restraining gambling, discouraging litigation, fostering education, and so on, will be readily admitted ; but to our mind the greatest of all are the stimulation of self-reliance, the growth of a spirit of self-confidence and enterprise, the appreciation of the practicability of achieving economic liberty, the realization that a member need not of necessity remain the serf of the moneylender but can, by the strength of his character and the persistence of his own effort, achieve full independent manhood, master of his own destiny. There is just a suggestion that Professor Mukherji has never visited an old-established society and witnessed the pride of those who have by their own efforts struggled out of debt, redeemed their land, and pushed the wily *bania* out of the village. The great mass of the people are neither drunkards nor gamblers awaiting redemption, but debt-ridden cultivators from whom all ambition to improve their methods has been long ago driven by the sense of hopeless helplessness born of a vicious system of credit.

It might be possible to point to one or two other minor defects which should receive consideration in a later edition, but of the book as a whole we would say nothing but praise. It is the only source whence can be derived information on the movement as a whole ; it is singularly complete and is throughout characterized by level-headed treatment ; it should prove invaluable to all students of one of the greatest and most important attempts to upraise the

mass of the people and should find a place in the libraries of all who have the welfare of the true people of India at heart. [H. C.]

* * *

Happy India, as it might be if guided by Modern Science.—By ARNOLD LUPTON. Pp. 188. (London : George Allan and Unwin, Ltd.) Price, 6s.

THE book is the result of a tour undertaken by the author in 1914 in order to get some idea of the actual condition of India. His suggestions for relieving the poverty which he found are summarized in the following passage :—

“ If the people of India wish to be healthy, wealthy, comfortable and happy, they will at once carry out all the well-known sanitary measures which I have mentioned. They will adopt immediately a more intensive system of agriculture. They will proceed without delay with afforestation, with great irrigation, drainage and land reclamation works. They will get more hydro-electric power stations. And at the same time they will so organize their family life that the population does not tend to increase more than, say, one million a year, so that it shall not be necessary for death in the shape of ‘ fevers ’ and other horrible diseases to slaughter them.”

These suggestions represent for the most part ideals which, it is needless to say, are always before the Government of India, but which the author says should be realized immediately. He indicates obvious ways in which effect can be given to his recommendations—ways which again, it is needless to say, whether practicable or not, are familiar to the men on the spot. He does not indicate the means by which they are to be carried out—but then he is not responsible for India’s finances.

As a statement of ideals we may heartily commend the book. As an indictment of the feebleness of Government’s efforts to realize its ideals we may admire its candour—and the public spirit of its author—but we can only say that, however absurd the fact may be, no Government in the world has yet succeeded in freeing itself of the cramping necessity or, rather, habit of horrowing money at

interest—the rate of which strictly limits the sphere of practical politics. [A. C. D.]

* * *

The Common Birds of India.—By DOUGLAS DEWAR. Illustrated by G. A. LEVETT-YEATS. Vol. I, Part I, pp. viii + 44 illustrations. (Calcutta: Thacker, Spink & Co.) Price, Rs. 2-8-0.

THIS is the first part of a volume to be devoted to those birds in which the sportsman is most interested, *i.e.*, the ducks, pheasants and pigeons. This subject has already been covered by such volumes as those by Hume and Marshall on the Game-birds of India, by Stuart-Baker on Ducks and Snipe, and by Beebe's luxurious monograph on the Pheasants, but all these books are expensive and perhaps rather unnecessarily detailed for the ordinary man who wishes to find out just a little about the birds which he may come across in every-day life. To such, the present may be commended as offering at a reasonable price the modicum of information required. The reading-matter is well written in a clear and attractive style and the illustrations suffice for the recognition of the birds indicated, although some (*e.g.*, that on page 41) are not quite so life-like as they might be, and we fully realize the extreme difficulty of securing in India the requisite combination of ornithological accuracy and artistic skill.

In our own series on Birds, appearing in this Journal, we have purposely omitted consideration of all game-birds, as they have been dealt with already in other works, and we considered that there was more need of an illustrated account of the commoner birds found in and around gardens in India, most of the illustrations in standard works on ornithology being devoted to new or rare species. There is, however, a decided demand in India for well-illustrated and not too technically written accounts of the more common birds. The present volume of Mr. Dewar's book, as already indicated, will deal with the wild fowl, game-birds, and pigeons, and, if the first volume is successful, it is proposed to issue a further four volumes dealing with all the common birds of India. We hope that the financial aspect of this first volume will justify the early publication of the other volumes thus promised. [T. B. F.]

NEW BOOKS

ON AGRICULTURE AND ALLIED SUBJECTS.

1. Citrus-By-Products and Utilization of Wastes, by S. K. Mitra. Pp. 101. (Dacca: Krishi-sampad Office.) Price, R. 1-8.
2. Fertilization of Tea in India, 1923-24. (Calcutta: Allen Bros. & Co. (India), Ltd.)
3. Farm Implements and Machinery, by J. R. Bond. Pp. xvi + 282. (London: Benn Bros., Ltd.) Price, 35s. net.
4. Poultry Keeping on the Farm, by E. Brown, Pp. 54. (London: Benn Bros., Ltd.) Price, 2s. net.
5. Pests of the Garden and Orchard, by Ray Palmer and W. Percival Westell. Pp. 413 + 47 Plates. (London: Henry J. Drane, Farringdon Street, n. d.) Price, 25s. net.
6. Encyclopædia of Veterinary Medicine, Surgery and Obstetrics, by Prof. George H. Wooldridge. In 2 Vols. Vol. 1: Veterinary Medicine. Pp. xiv + 546 + xxiii. Vol. 2: Surgery and Obstetrics. Pp. viii + 547-1,106 + xxx. (London: H. Frowde and Hodder and Stoughton.) Price, £6 6s. net.
7. Dates and Date Cultivation of the Iraq. Part 3. (Agricultural Directorate, Ministry of Interior, Iraq, Mesopotamia. Memoir No. 3.) Pp. v + 97. (Cambridge: W. Heffer and Sons, Ltd.) Price, 10s. net.
8. The Principles of Agriculture: A Text-book for Lectures on Agriculture, Rural School Masters, Young Farmers, and Students of Agriculture, by J. M. Cutcheon. Pp. 217. (Edinburgh: E. and S. Livingstone.) Price, 4s. 6d. net.

THE following publications have been issued by the Imperial Department of Agriculture in India since our last issue :—

Memoirs.

Note on the Permanent Plots, Coimbatore, by Roland V. Norris, D.Sc. (Chemical Series, Vol. VI, No. 8.) Price, R. 1-4 or 1s. 9d.

Studies of an Acid Soil in Assam, by A. A. Meggitt, B.Sc., F.C.S. (Chemical Series, Vol. VII, No. 2.) Price, As. 12 or 1s.

Bulletins.

The Cultivation of Lac in the Plains of India, by Rai Bahadur C. S. Misra, B.A. (Bulletin No. 142.) Price, R. 1-8.

Ber (*Zizyphus jujuba*) Fruit and its Fly Pest, by J. L. Khare, F.E.S. (Bulletin No. 143.) Price, As. 6.

Some Observations on the Barren Soils of Lower Bari Doab Colony in the Punjab, by S. M. Nasir. (Bulletin No. 145.) Price, As. 3.

Miscellaneous.

Catalogue of Indian Insects : Part 2—Culicidæ, by R. Senior-White, F.E.S. Price, R. 1-10.

VOL. XVIII, PART V

September, 1923

THE AGRICULTURAL JOURNAL OF INDIA



EDITED BY

The Agricultural Adviser to the Government of India

PUBLISHED FOR

THE IMPERIAL DEPARTMENT OF AGRICULTURE IN INDIA

BY

THACKER, SPINK & CO., CALCUTTA

W. THACKER & CO., 2, CREED LANE, LONDON

Price R. 1-8 or Two Shillings

Agents for the Sale of Government Publications

IN EUROPE

- Constable & Co., 10, Orange Street, Leicester Squares, London, W.C.
Kegan Paul, Trench Trübner & Co., 68-74, Carter Lane, E.C., and 25, Museum Street, London, W.C.
Bernard Quaritch, 11, Grafton Street, New Bond Street, London, W.
P. S. King & Sons, 2 & 4, Great Smith Street, Westminster, London, S.W.
H. S. King & Co., 65, Cornhill, E.C., and 9, Pall Mall, London, W.
Grindlay & Co., 54, Parliament Street, London, S.W.
Luzac & Co., 46, Great Russell Street, London, W.C.
W. Thacker & Co., 2, Creed Lane, London, E.C.
T. Fisher Unwin, Limited, 1, Adelphi Terrace, London, W.C.
B. H. Blackwell, 50 & 51, Broad Street, Oxford.
Deighton, Bell & Co., Ltd., Cambridge.
Oliver & Boyd, Tweeddale Court, Edinburgh.
E. Ponsonby, Ltd., 116, Grafton Street, Dublin.
Ernest Leroux, 28, Rue Bonaparte, Paris.
Martinus Nijhoff, The Hague, Holland.
Otto Harrassowitz, Leipzig.
Friedlander and Sohn, Berlin.

IN INDIA AND CEYLON

- Thacker, Spink & Co., Calcutta and Simla.
W. Newman & Co., Calcutta.
R. Cambray & Co., Calcutta.
S. K. Lahiri & Co., Calcutta.
B. Bannerjee & Co., Calcutta.
The Indian School Supply Depot, 309, Bow Bazar Street, Calcutta, and 226, Nawabpur, Dacca.
Butterworth & Co. (India), Ltd., Calcutta.
Rai M. C. Sarkar Bahadur & Sons, 75-1-1, Harrison Road, Calcutta.
The Weldon Library, 57, Park Street, Calcutta.
Standard Literature Co., Ltd., Calcutta.
Lal Chand & Sons, Calcutta.
Higginbothams, Ltd., Madras.
V. Kaliyanarama Iyer & Co., Madras.
G. A. Natesan & Co., Madras.
S. Murthy & Co., Madras.
Thompson & Co., Madras.
Temple & Co., Madras.
P. R. Rama Iyer & Co., Madras.
E. M. Gopalakrishna Kone, Madras.
Thacker & Co., Ltd., Bombay.
A. J. Combridge & Co., Bombay.
D. B. Taraporewala, Sons & Co., Bombay.
Mrs. Radhabai Atmaram Sagoon, Bombay.
Sunder Pandurang, Bombay.
Gopal Narayan & Co., Bombay.
Ramchandra Govind & Son, Kalbadevi, Bombay.
A. H. Wheeler & Co., Allahabad, Calcutta and Bombay.
N. B. Mathur, Superintendent. Nazir Kanun-i-Hind Press, Allahabad.
Rai Sahib M. Gulab Singh & Sons. Mufid-i-Am Press, Lahore.
A. Chand & Co., Lahore, Punjab.
Ram Krishna & Sons, Lahore.
Superintendent, American Baptist Mission Press, Rangoon.
Manager, the "Hitavada," Nagpur.
S. C. Talukdar, Proprietor. Students & Co., Cooch Behar.
A. M. & J. Ferguson, Colombo, Ceylon.
Manager, Educational Book Depôts, Nagpur and Jubbulpore.*
Manager of the Imperial Book Depot, 63, Chandney Chank Street, Delhi.*
Manager, "The Agra Medical Hall and Co-operative Association, Ltd." (Successors to A. John & Co., Agra.)*
Superintendent, Basel Mission Book and Tract Depository, Mangalore.*
P. Varadachary & Co., Madras.*
H. Liddell, Printer, etc., 7, South Road, Allahabad.*
D. C. Anand & Sons, Peshawar.*
Ram Dayal Agarwala, 184, Katra, Allahabad.*
Manager, Newal Kishore Press, Lucknow.*

* Agents for the sale of Legislative Department Publications only.

CONTENTS

(VOL. XVIII, PART V)

ORIGINAL ARTICLES

	PAGE
SOME COMMON INDIAN BIRDS. NO. 23. THE JUNGLE CROW (<i>Corvus coronoides levaillanti</i>) ..	<i>T. Bainbrigg</i> <i>Fletcher, R.N.,</i> <i>F.L.S., F.E.S.,</i> <i>F.Z.S.; and C.M.</i> <i>Inglis, M.B.O.U.,</i> <i>F. E. S., F. Z. S.</i> 451
DIGESTION EXPERIMENTS WITH PADDY STRAW ..	<i>F. J. Warth, M.Sc.</i> 456
INBREEDING IN COTTON AND ITS IMPORTANCE TO THE PLANT BREEDER	<i>S. C. Harland, D.Sc.</i> <i>(Lond.), F.L.S.</i> 465
ON THE PROBABLE ERROR IN VARIETY TRIALS WITH PADDY	<i>B. N. Sarkar, L.Ag.</i> 475
THE OPERATIONS AGAINST THE BUD-ROT OF PALMYRA PALMS ON THE EAST COAST ..	<i>W. McRae, M.A.,</i> <i>B.Sc.</i> .. 487
THE INFLUENCE OF NOTCHING ON THE YIELD OF THE FIG TREES	<i>G. S. Cheema,</i> <i>M.Sc.; and S. R.</i> <i>Gandhi, B.Ag.</i> .. 501
THE MOSAIC DISEASE OF SUGARCANE IN INDIA ..	<i>Jehangir Fardunji</i> <i>Dastur, M.Sc.,</i> <i>D. I. C.</i> .. 505
POULTRY BREEDING IN THE UNITED PRO- VINCES	<i>Mrs. A. K. Fawkes</i> 510
THE RELATIONSHIP OF THE SPECIES OF <i>Fusarium</i> CAUSING WILT AND DRY ROT OF POTATOES IN WESTERN INDIA	<i>S. L. Ajrekar, B.A.;</i> <i>and M. N.</i> <i>Kamat, B.Ag.</i> .. 515

	PAGE
SELECTED ARTICLES	
HAWAIIAN SUGAR FACTORY RESULTS FOR THE 1922 SEASON ..	521
DECLINE IN THE AVERAGE YIELD OF EGYPTIAN COTTON ..	525
NOTES	
POST-GRADUATE TRAINING IN AGRICULTURE AT PUSA ..	528
COTTON RESEARCH STUDENTSHIPS	532
HOW TO MAKE MANURING PROFITABLE IN INDIA ? ..	534
ROOT DISEASE OF SUGARCANE IN JAVA	536
IS FLOWERING A SERIOUS DRAWBACK IN A NEW SUGARCANE ? ..	538
REPORT ON THE THIRD ALL-INDIA EGG-LAYING COMPETITION ..	539
SOIL ACIDITY AND PLANT DISTRIBUTION	545
THE WORLD'S DAIRY CONGRESS	546
UNITED PROVINCES POULTRY ASSOCIATION	547
MEXICAN MALVAVISCO PLANT AS A SUBSTITUTE FOR JUTE ..	547
BLENDING INDIAN AND AMERICAN COTTON	548
CHINESE COTTON	550
COTTON RESEARCH	552
PERSONAL NOTES, APPOINTMENTS AND TRANSFERS, MEETINGS AND CONFERENCES, ETC.	555
REVIEW	
REPORT ON AN ENQUIRY INTO WORKING CLASS BUDGETS IN BOMBAY	558
CORRESPONDENCE	
THE CATTLE PROBLEM IN INDIA	560
RIPENING OF COCONUT FLOWERS	561
NEW BOOKS ON AGRICULTURE AND ALLIED SUBJECTS ..	562

LIST OF ILLUSTRATIONS

	The Jungle Crow (<i>Corvus coronoides levaillanti</i>) ..	Frontispiece
		Facing page
Plate	XVI. Estimated yield curve for paddy No. 51 on Kanke farm	482
„	XVII. Normal fertility curve of paddies on Kanke farm ..	484
„	XVIII. Area infected by bud-rot of palms in Godavari and Kistna Districts	499
„	XIX. Mosaic on leaves of Sathi 131 sugarcane ..	506
„	XX. <i>Fusarium</i> causing wilt and dry rot of potatoes ..	520

**The following Original Articles will appear in our next issue
(November 1923).**

- SOME COMMON INDIAN BIRDS. No. 24. THE
 BENGAL TREE PIE (*Dendrocitta rufa vagabunda*) T. Bainbrigge Fletcher,
 R.N., F.L.S., F.E.S.,
 F.Z.S.; and C. M. Inglis,
 M.B.O.U., F.E.S., F.Z.S.
- FURNACES FOR THE MANUFACTURE OF *Gur* H. R. Stewart, A.R.C.Sc.I.,
 D.I.C., N.D.A.; and
 Sardar Sahib Kharak
 Singh, M.A.
- EXPERIMENTS ON WHEAT THRESHING AT
 LYALLPUR H. R. Stewart, A.R.C.Sc.I.,
 D.I.C., N.D.A.; and
 D. P. Johnston,
 A.R.C.Sc.I., N.D.A.
- THE MESQUITE (*Prosopis juliflora*) .. W. Robertson Brown.
- THE GRAM CROP IN BURMA A. McKerral, M.A., B.Sc.
- POLLINATION METHODS AMONGST THE LESSER
 MILLETS W. Youngman, B.Sc.; and
 S. C. Roy, L.Ag.
- SOME ECONOMIC PLANTS OF THE NAGA HILLS J. H. Hutton, I.C.S.
- LINKAGE RELATIONS IN THE COTTON PLANT .. K. I. Thadani, M.Sc.,
 F.L.S.
- THE CULTIVATION OF POTATO IN ITALY .. G. S. Kulkarni, M.Ag.
- ROOT PRUNING OF THE MANGO PLANT .. Raj Kishore Singh, B.Sc.



THE JUNGLE CROW (*CORVUS CORONOIDES LEVALLANTI*)

Original Articles

SOME COMMON INDIAN BIRDS.

No. 23. THE JUNGLE CROW (*CORVUS CORONOIDES LEVAILLANTI*).

BY

T. BAINBRIGGE FLETCHER. R.N., F.L.S., F.E.S., F.Z.S.,
Imperial Entomologist ;

AND

C. M. INGLIS, M.B.O.U., F.E.S., F.Z.S.

THE "country cousin" of the House Crow is the Jungle Crow which, although it seems to prefer a *mofussil* life, is often seen, like human country-folk, in large towns to which it comes on a shorter or longer visit or in which it is frequently a permanent dweller. The House Crow and the Jungle Crow are the only two crows found commonly distributed in the Plains of India and are easily distinguishable, the House Crow being a smaller bird with a grey neck, the Jungle Crow being larger, with a heavier bill and black neck. In the extreme North, in areas bounding the Hills, other species of *Corvus*, such as the Raven, the Carrion-Crow, the Eastern Rook and the Eastern Jackdaw, descend to the Plains in the winter months. Of these, the Raven, distinguished by its much larger size, is common throughout the year as far South as the United Provinces ; the Carrion-Crow, found along the North-West Frontier, is much like the Jungle Crow but with more intensely black plumage ; the Eastern Rook, which is also somewhat like the Jungle Crow but has a more slender bill, the base of which is bare of feathers in adult birds, and the lower plumage intensely glossed

with blue and purple, is also found along the North-West Frontier and often does considerable good by feeding on grasshoppers and other insects on cultivated land; whilst the Eastern Jackdaw, which looks more like the House Crow but has the chin and throat grey like the breast, is found in the winter as far South as Ferozepur and as far East as Ambala.

The Jungle Crow is found throughout the Plains of India, and has been divided into forms, distinguished by length of wing and bill, the medium-sized form being the subject of our Plate, whilst in Southern India and Ceylon it is replaced by the Southern Jungle Crow (*Corvus coronoides culminatus*) with much shorter wing and smaller, slenderer bill; in the Himalaya it is replaced by the Himalayan Jungle Crow (*Corvus coronoides intermedius*), a larger race with the bases of the feathers in adult birds pale or pure white, and in the Andamans there is found the Andaman Jungle Crow (*Corvus coronoides andamanensis*) which is also a larger race with a longer and stouter bill. All the Indian forms, it may be added, are merely races of the Australian Jungle Crow, whilst the form *macro-rhynchus*, under which name the Indian crows have usually been placed, is found in Java. It will be seen, therefore, that, like its grey-necked relation, the Jungle Crow affords an example of species in the making, its representatives in various geographical areas (the Himalaya, the North Indian Plains, South India and Ceylon, Andamans, Australia) having acquired in each area a characteristic facies without having as yet overpassed the rather vague limits which bound the sum-total of characters constituting a species. Although this bird is not a regular migrant and seems to keep to restricted areas in its wilder haunts, yet the races which have taken to scavenging cities and villages for food probably travel over very wide areas in the non-breeding season, and the result of this habit is that the limits of the geographical areas tend to overlap.

Except for its preference for a country life, in habits the Jungle Crow is much like the House Crow. Not being such a confirmed parasite of man, however, it is not so bold as its grey-necked relative. The subspecies *levaillanti*, however, in particular, seems to be in process of semi-domestication and is usually found within easy

distance of human habitations where an easier living is obtainable, either by open scavenging or by following agricultural operations such as ploughing or irrigating. When such are going on, this crow soon discovers the fact and congregates, with many other birds, following the plough and picking up insects exposed by the turning of the soil, and also feeding on insects driven out by irrigation-water. This crow also attends cattle, picking ticks off the animals and also feeding on dung-beetles attracted to their excrement. Other animal food taken under non-scavenging conditions includes caterpillars, beetles, grasshoppers, etc., centipedes, worms, frogs and lizards. The Jungle Crow is very fond of frogs and lizards and, like the House Crow, apparently often worries them to death and then does not eat them. Young chickens, pigeons and even kids are sometimes treated in the same way. The young and eggs of other birds are always eaten if opportunity occurs and this propensity is so well known that, should it venture into or near the tree containing their nests, this crow is vehemently hustled away by such birds as Drongos and Black-headed Orioles. Carcasses of animals are fed on and a corpse floating down a river is usually attended by some of these black ghouls. Vegetable food, however, seems to be taken far in excess of animal and many crops are attacked to a destructive extent. Maize, especially in the case of early crops or under garden cultivation, suffers considerably and in Madras this crow also damages ripening paddy. It is also fond of ground-nuts and, in many districts where this crop is grown, coolies with slings have to be employed as bird-scarers. When in season, the Jungle Crow is also very partial to the flowers of the silk-cotton tree (*Bombax malabaricum*), to all kinds of fig fruit, and to mulberries. Mr. Mason states that the stomachs, which he examined, almost invariably contained vegetable matter much in excess of any other food material. From an agricultural view-point this crow may probably be classed as of neutral or faintly beneficial value, the damage done to crops by pulling up germinating seeds and eating of ripening grain and fruits being compensated, or perhaps slightly more than compensated, by the good done by its feeding on injurious insects. In sufficiently insanitary localities this crow does a little

good by scavenging but is more of a nuisance around houses by its thievish habits. Like most of its tribe, the Jungle Crow is fond of carrying off any bright articles sufficiently small for it to manage and silverware especially is greatly appreciated, the disappearance of small spoons, etc., being often attributable to crows. On one occasion when I was at Coimbatore, a crow was seen to carry off a tea-spoon from the verandah of a bungalow and fly with it onto the roof; a search on the roof revealed, not only the missing spoon, but three others which had been misappropriated in the same way. It is hard to say wherein lies the attraction for glittering objects of this kind, which are of no use for purposes of interior economy, but it is certainly a very real one, and little seems to come amiss, even pieces of ice being carried off at times. Sometimes the object taken is simply carried off and dropped, sometimes it is promptly buried, in which case it may be dug up again and re-buried and is then apparently forgotten. A golf-ball, especially a new one, is often an irresistible attraction, being carried off and eventually dropped at a distance; presumably it is mistaken for an egg. Dewar, however, relates how he once scored off a crow by dropping an "approach shot" onto its back as it was swaggering about in the neighbourhood of the "green." He also tells a story of a rook which attempted to hatch out a golf-ball in mistake for an egg.

The Jungle Crow seems to be much less clannish than his grey-necked relation, which is kept in its proper place when the two species enter into competition for food. It is also less gregarious and in the *mofussil* each pair has often its own particular area from which it excludes all other crows. The breeding-season is very variable according to locality, usually from January to April, earlier in the South and later in the North. The nest, which is placed in a high tree, is a well-made cup of small, flexible twigs, compactly intermixed with leaves or softer material, and lined with grass or hair. The usual number of eggs is four or five, rarely more, the egg being about 40 by 29 mm., and spotted, as shown in our Plate, with dull red or brown on a ground-colour of bluish-green. Like the House Crow, this species is also parasitized by the Koel and by the Muscid fly, *Passeromyia heterochaeta*,

In Indian folk-lore the crow often acts as a messenger and is supposed to announce approaching visitors. Crows are also often fed as a propitiation to spirits and, when a child is sick, crows and other birds may be bought by its mother and female relatives and released as a propitiation. The crow is generally regarded as a type of knavery and inferiority,—in short, as a wicked rascal. The local vernacular name for this crow in North Bihar is *Kag*, that for the House Crow being *Kowa*.

DIGESTION EXPERIMENTS WITH PADDY STRAW.

BY

F. J. WARTH, M.Sc.,

Physiological Chemist, Agricultural Research Institute, Pusa.

THE experiments described in the present paper refer to two bullocks which were fed for 10 months on a ration consisting of paddy straw together with a small amount of concentrates. No green food was given.

During the greater part of the test the actual quantities of food supplied to the two animals were :—

1. Mahadeva (average body weight 500 lb.)—8·8 lb. straw, 12·8 oz. cake, 12·8 oz. maize.
2. Kailas (average body weight 700 lb.)—11·0 lb. straw, 1 lb. cake, 1 lb. maize.

Towards the end of the feeding period the maize was deleted from the ration and the cake increased slightly in order to bring the protein supply up to the previous level.

It should be noted here that the average live weights of the two animals are in the proportion of 1 : 1·40, while the food given is in the proportion of 1 : 1·25.

During the course of the feeding trial digestion determinations were carried out on five occasions, the tests in each case covering about 12 days. The average results obtained in these digestion experiments are given in Table I.

TABLE I.

Average digestion co-efficients for the mixed ration.

		Dry matter	Organic matter	Total nitrogen	Ash	Ether extract	Fibre	Nitrogen free extract		
M A H A D E V A	FOOD	Concentrate ..	587.9	552.4	26.11	35.5	56.0	29.0	303.9	
		Straw ..	3,665.2	3,007.7	18.32	659.5	52.3	1,269.1	1,569.9	
		TOTAL ..	4,253.1	3,560.1	44.43	695.0	108.3	1,298.1	1,873.8	
	Fæces ..	2,099.0	1,467.9	24.05	631.1	30.0	390.0	904.9		
	Food digested ..	2,154.1	2,092.2	20.38	63.9	78.3	908.1	968.9		
	Digestion co-efficient ..	50.6	58.2	45.80	..	71.8	69.8	51.6		
	K A I L A S	FOOD	Concentrate ..	750.5	707.2	33.26	43.3	72.8	36.3	390.3
			Straw ..	4,501.0	3,669.6	22.11	831.3	73.1	1,574.1	1,884.3
			TOTAL ..	5,251.5	4,376.8	55.37	874.6	145.9	1,610.4	2,274.6
		Fæces ..	2,544.0	1,779.4	30.15	763.8	39.4	450.4	1,119.2	
Food digested ..		2,707.5	2,597.4	25.22	110.8	106.5	1,160.0	1,155.4		
Digestion co-efficient ..		51.5	59.3	45.02	..	72.7	72.0	50.5		

It may be noted that the digestion co-efficients obtained from the two animals agree very well in every particular. About half of the total dry matter supplied in the food is digested and half excreted. Of the organic matter very nearly 60 per cent. is digested. Coarse, therefore, though the bulk of the food undoubtedly was, the animals were able to utilize it to a very satisfactory extent.

The digestion of crude protein was found to vary somewhat in the different tests. As it is an important item in the ration, the figures relating to protein digestion are given in full in Table II.

TABLE II.

Digestion of crude protein in the mixed ration. Quantities of total nitrogen in gm. per day.

Crude proteid nitrogen		Expt. I	Expt. II	Expt. III	Expt. IV	Expt. V	
MAHADEVA	FOOD {	Straw	22.65	18.57	17.00	15.07
		Concentrate	26.10	25.14	26.00	27.18
		TOTAL	48.75	43.71	43.00	42.25
	In fæces	25.57	25.12	23.22	22.29	
	Food digested	23.18	18.59	19.78	19.96	
Digestion co-efficient	47.50	42.60	46.00	47.20		
KAILAS	FOOD {	Straw ..	19.0	28.30	23.20	21.20	18.80
		Concentrate ..	34.3	33.80	31.50	32.60	34.10
		TOTAL ..	53.3	62.10	54.70	53.80	52.90
	In fæces ..	29.8	31.34	31.20	29.70	28.60	
	Food digested ..	23.5	30.80	23.50	24.10	24.30	
Digestion co-efficient ..	44.0	49.60	42.90	44.70	45.80		

In this table the relatively high digestion co-efficients obtained in Experiment II are worth noticing. They are undoubtedly due to better quality straw during this period, as will be shown later.

In the other tests the digestion co-efficient is seen to increase as the proportion of "concentrate nitrogen" is increased. The amount of nitrogen in the fæces, on the other hand, increases as the amount of straw nitrogen is augmented.

The figures as a whole show that small differences in the nitrogen content of the straw may be expected to produce distinct differences in feeding results. This important point will be considered again later.

DAILY ASSIMILATION OF NUTRIENTS.

The figures for daily assimilation were obtained in the course of the digestion experiments and are given in Table I. It merely remains to express them in a simpler form which is more generally adopted.

For this purpose the digestible crude fibre and digestible nitrogen free extract are considered to be similar, and their sum is

designated digestible carbohydrate. The digestible crude protein is found by multiplying the nitrogen figure by 6.25. The values thus obtained from Table I and converted into pounds are shown in Table III.

TABLE III.

Average daily assimilation of nutrients.

	Mahadeva Body wt. 500 lb.	Kailas Body wt. 700 lb.	Ratio of food assimilated
	lb.	lb.	
Proteid	0.280	0.347	1 : 1.24
Carbohydrate	4.130	5.116	1 : 1.24
Fat	0.170	0.234	1 : 1.38
Nutritive ratio of digested food	1 : 16.1	1 : 16.3	..

The last column shows that the proportion of nutrients digested by the two animals agrees closely with the proportion in which the food was given, namely, 1 : 1.25. The nutritive ratio of the digested food is seen to be a wide one. It would appear that such a ratio must be considered normal for bullocks in India.

MAINTENANCE RATIONS FOR BULLOCKS.

During the feeding tests the animals were weighed regularly. A gain in weight was observed but it was scarcely greater than the experimental error.

In condition also the animals improved somewhat but the improvement was slight.

The evidence of this long period feeding test, therefore, shows that the ration given was just above a maintenance standard. As such, it is of considerable importance in itself, and is also of interest for purposes of comparison with standards worked out in other countries.

From the results of Table III by calculation it is found that to maintain a 1,000 lb. bullock in the same condition as our experimental animals would require the following amounts of digestible nutrients, *viz.*, 0.52 lb. protein, 6.5 lb. carbohydrate and

0.28 lb. fat. This is a distinctly lower ration than the old maintenance standards of Wolff and Kühn which allowed 0.7 to 0.75 lb. digestible protein and 6.6 to 8 lb. digestible carbohydrate.

Armsby's energy standard allows 0.5 lb. protein and 6 therms energy for strict maintenance, while Hacker's standard for strict maintenance is 0.6 lb. digestible protein and 6 lb. digestible carbohydrate.

The above preliminary results obtained at Pusa may be considered a first approximation towards a maintenance ration.

This ration is, according to experiments now in progress at Pusa, undoubtedly liberal as regards protein. Further work will no doubt prove the local bullock to be a very thrifty animal. A more strict maintenance ration, however, still remains to be determined.

DIGESTIBILITY OF STRAW.

This can be estimated in the first place from the data contained in Table I by making allowance in the usual manner for the digestibilities of the concentrates used.

The data so obtained are given in Table IV in full.

TABLE IV.

Digestion co-efficients for paddy straw.

			DIGESTION CO-EFFICIENTS				
			Fat	Dry matter	Organic matter	Fibre	Carbohydrate
Expt. I	..	Kailas ..	61.1	44.1	55.2	71.9	36.4
		Mahadeva
.. II	..	Kailas ..	67.3	49.9	61.7	72.3	40.5
		Mahadeva ..	65.0	44.1	53.7	69.3	41.6
.. III	..	Kailas ..	75.2	47.0	56.5	71.9	45.8
		Mahadeva ..	68.7	45.3	54.6	67.4	47.3
.. IV	..	Kailas ..	64.8	44.8	55.6	71.1	40.5
		Mahadeva ..	61.4	43.4	54.0	68.9	39.3
.. V	..	Kailas ..	50.6	50.3	61.9	75.7	50.5
		Mahadeva ..	50.3	50.0	60.9	78.7	50.1
.. VI	..	Kailas ..	59.9	51.3	59.4	75.5	49.7
		Mahadeva ..	59.9	46.9	54.6	72.1	43.5
AVERAGE ..			62.2	47.0	57.1	72.0	44.1

This table also contains data obtained in a sixth digestion experiment which has not been referred to before. It was carried out at the conclusion of the long period feeding trial. The ration during the sixth digestion experiment consisted of straw alone without concentrate, so that the digestibility of the straw was in this case determined directly without the need for a correction on account of added concentrate.

The results of the six experiments do not agree perfectly. The variations are due partly to changes in straw quality and partly to normal fluctuations in the digestion capacities of the animals.

The nitrogen digestion is not included here. It is discussed in greater detail below. The averages of Table IV show that the organic matter of paddy straw is digested to the extent of 57 per cent. Of this organic matter the fibre fraction is much more readily digested than the nitrogen free extract, the digestion co-efficients for these two constituents being 72 per cent. and 44 per cent. respectively. The corresponding averages found in American experiments are 59 per cent. and 46 per cent. respectively.

Given straw of normal composition, these figures indicate that our bullocks have digested 10 per cent. more organic matter than was digested in the American experiments.

The total amount involved is not large, but a 10 per cent. increase in digestion means a much greater increase in the net energy value of the food. It would appear from these results that the energy derived from paddy straw in the Pusa experiments was by no means negligible, as it is sometimes contended to be.

Indeed, the fact that the animals were maintained for such a length of time on a ration in which the concentrate could not have yielded more than a fraction of the energy requirements of the animals is in itself a proof that the straw yielded a large proportion of the energy for maintenance. This was derived from the digestible carbohydrate and fibre.

DIGESTION OF STRAW NITROGEN.

The results for the apparent digestion of straw nitrogen are of special interest. Full data are shown in Table V.

TABLE V.

Digestion of nitrogen in relation to straw composition.

				Per cent. nitrogen in straw	QUANTITY DIGESTED DAILY BY	
					Kailas	Mahadeva
					gram.	gram.
Experiment	I	0.442	- 3.30
..	II	0.642	+ 4.10	+ 2.56
..	III	0.502	- 1.37	- 1.25
..	IV	0.492	- 1.64	- 0.76
..	V	0.402	- 3.01	- 1.78
..	VI	0.402	- 2.82	- 3.05

It would appear from these results that only in one set of tests (Expt. II) was there a favourable balance of nitrogen from the straw. In the remaining tests the digestion was negative, more nitrogen being eliminated in the fæces than was supplied by the straw.

These figures, because in five of the experiments they were obtained indirectly by making allowance for the assumed digestibility of the concentrated food, might be called in question; but they are amply confirmed by the results of the last test in which straw alone was fed and consequently no correction was necessary. The last experiment proves in fact that the digestion co-efficients of nitrogen assumed for the concentrates in the first five tests represent very accurately the actual digestibilities attained.

Further light on this adverse balance is obtained by examining the figures for the nitrogen content of the straw during each of the above tests. The figures make it clear that the positive digestion in Experiment II is associated with an unusually high nitrogen content of the straw. In the succeeding experiments the nitrogen content of the straw diminished steadily, and with this diminishing nitrogen content of the straw there occurred a fairly regular increase of adverse balance. •

The experiments indicate that small changes in the nitrogen content of the straw may make all the difference between a positive and negative balance of nitrogen. We have been apt to take little note of such small differences in straw composition in the past. The experiments described above will have served a useful purpose if more emphasis is in future laid on these small differences.

Another aspect of the matter must also be referred to. In Experiments I and II fresh straw was used, but the samples having been obtained from different cultivators differed considerably in nitrogen content. Here the difference in nitrogen content is related to differences in straw quality at harvest time—the one giving a bad negative balance, the other a positive balance.

Experiments III, IV, V and VI were, however, carried out with straw which was initially much the same as that used in Experiment II but gradually deteriorated in keeping as is shown by the steady fall in its nitrogen content. It would appear, therefore, that serious loss of quality (as regards nitrogen content) is likely to result from exposure to the weather, or during storage. This point undoubtedly deserves attention.

It is necessary finally to add some remarks on the nitrogen requirements of bullocks in this country.

The long period feeding test with a mixed ration (Table II) showed that when these animals digested 25 and 20 gm. nitrogen respectively per day they were able to put on some flesh. For strict maintenance the nitrogen metabolism (*i.e.*, the nitrogen excreted in the urine) should be somewhat less than these amounts.

Accurate data are at present wanting, but from experiments now in progress at Pusa it would appear that from 12 to 15 gm. is the minimum quantity required to maintain a nitrogen balance in the animals of the size experimented with. Compared with experience in other parts of the world this is a low figure, and yet it far exceeds the greatest amount which the animals were able to assimilate from the straw, namely, 4 gm. in Experiment II. Even with this straw, if fed alone, there would be a marked daily deficit.

•

In the other tests the daily loss of nitrogen on a purely straw ration would have been serious. Without the addition of some concentrate, therefore, it appears unlikely that any paddy straw can maintain the nitrogen balance.

To minimize this demand for expensive concentrates it is essential to avoid loss of nitrogen from the straw by exposure to the weather.

The following figures are instructive in this connection. In Experiment II, Kailas had a net positive digestion of 4 grm. nitrogen. Later in Experiment V he had a negative digestion of 3 grm. nitrogen from similar straw after it had lost quality. The total difference in nitrogen is 7 grm. By using the better straw, therefore, the concentrate could be reduced by one-half—a result which is of very great significance.

INBREEDING IN COTTON AND ITS IMPORTANCE TO THE PLANT BREEDER.

BY

S. C. HARLAND, D.Sc. (London), F.L.S.,
Late Imperial Department of Agriculture for the West Indies.

INTRODUCTION.

THE methods to be followed in the improvement of any crop depend on the degree to which that crop will tolerate self-fertilization. It is the object of this paper to discuss the question of the effects of inbreeding in cotton, with particular reference to their practical significance to the plant breeder. A certain number of observations made by the writer in the West Indies, and hitherto unpublished, will also be described.

It will be convenient to summarize at the outset the observations of Shull¹, and of East and Jones², on the effects of inbreeding in maize. Maize is an especially suitable crop in which to elaborate the general effects of inbreeding into a series of general principles. This is because it is a crop which is ordinarily subject to a large amount of crossing in the field, and further because it has been studied carefully through no less than twelve generations of selfing.

SUMMARY OF THE EFFECTS OF INBREEDING IN MAIZE.

(1) The progeny of a self-fertilized maize plant is inferior in size, vigour, and productiveness to the progeny of a cross-bred plant from the same source.

(2) The decrease in vigour and productivity accompanying selfing becomes less in succeeding generations till, when

¹ Shull, G. H. The composition of a field of maize. *Amer. Breeders Assn. Rept.* (1908), 4, 296-301.

² East, E. M., and Jones, D. F. *Inbreeding and Outbreeding*, 1919.

approximate homozygosity is attained, a position of stability is reached.

(3) A number of monstrosities appear. The chief of these are : Dwarf plants rarely capable of producing progeny from their own pollen and plants showing various grades of pollen and ovule sterility.

(4) Strains differing markedly in ability to grow are isolated.

(5) Plants of surviving strains, while smaller in size and lower in productivity, are perfectly healthy and functionally normal in every way, except that in some strains a notable reduction in amount of pollen is found.

(6) Inbreeding seems to affect the plants in much the same way as poor environmental conditions.

(7) If the number of factor differences present in the original mother plant is large, most progress to homozygosity is made in the generations 3 to 6 of selfing. It is in these generations that most of the abnormal and defective types begin to appear as recessives, being formerly present in the stock but hidden by their dominant allelomorphs.

(8) The inbred strains after 8 to 12 generations of selfing are normal and healthy, and monstrosities such as seed in tassels, anthers in ears, and sterile forms no longer appear.

The main point of importance in the above is that a field of maize consists of a mixture of complex hybrids, enormously heterozygous, which are converted into elementary species in some ten generations of selfing. Some of these elementary species are characterized by more or less female sterility, but sterility is not a necessary consequence of inbreeding except in so far as genetic factors for sterility are segregated out into certain lines.

COMPARISON OF JONES' PURE LINES OF MAIZE WITH PURE LINES OF SELF-FERTILIZED PLANTS.

It will be instructive to draw an analogy between pure lines of *Pisum* and tobacco, normally self-fertilizing plants, and the pure lines of maize obtained by Jones after 12 generations of selfing, normal in every way except that vigour is lacking.

In field crop we are accustomed to see pure lines, or mixtures of pure lines of peas and complex hybrids of maize. *Pisum* is in no danger of becoming extinct, and neither, under suitable conditions, are the pure lines of maize. Both peas and maize when crossed with other pure lines show greatly increased vigour and productivity. Mendel's own observations on the increase in size of *Pisum* hybrids over the parents are particularly to be noted in this connection, as are East's experiments with tobacco, where an enormous increase in vigour can be obtained in the F_1 of certain crosses. The analogy between peas and maize when reduced to a state of genetic purity is complete. Imagining for a moment that maize is a self-fertilized crop and that Jones' pure lines are grown commercially, we should express no surprise at the yield normally given nor at the great increase of vigour and productivity through crossing, since we should be familiar with just as great an increase in other self-fertilizing lines when out-crossed. We should emphasize the increase in vigour through crossing rather than the evil results of inbreeding. Further, we should probably invent a practical method of utilizing F_1 vigour in maize just as is now being done with tobacco and tomatoes.

To sum up, inbred strains of naturally cross-fertilized plants are comparable in every respect with elementary species or biotypes of naturally selfed plants, provided that both have been subjected to natural selection.

RELATION OF VIGOUR TO DEGREE OF HETEROZYGOSIS.

The isolation of homozygous types is the one main demonstrable effect of inbreeding. It is true that a general reduction in vigour is experienced, which in the case of maize leads to a reduction in yield of 50 per cent. or more, but the diversity of the resulting strains depends directly on the genetic composition of the original mother plant, and is likely to vary with the amount of natural crossing to which that plant and its ancestors have been subjected. Any particular plant may be vigorous or weak, fertile or sterile, according to the particular combination of genes which it contains.

THE EFFECTS OF CONTINUED INBREEDING IN COTTON.

*Work of Leuke and Ram Prasad.*¹

On the results of some of their experiments with Indian cotton, Leake and Ram Prasad concluded that self-fertilization in one variety caused a marked diminution in fertility as measured by the percentage of fruits set in the second generation of selfing. With other varieties, continued selfing apparently brought about "a marked degree of sterility which is further associated with abortion or incomplete development of the stamens." The following is a summary of the evidence presented:—

TABLE I.

(From Leake and Ram Prasad.)

	TYPE 3				TYPE 9				TYPE 6a				TYPE 6b			
	Selfed		Crossed		Selfed		Crossed		Selfed		Crossed		Selfed		Crossed	
	No.	Set	No.	Set	No.	Set	No.	Set	No.	Set	No.	Set	No.	Set	No.	Set
1906	17	8	14	7	10	6	20	11
1907	20	3	6	2	21	9	22	11	20	10
1908	10	0	7	3	18	9	1	0	16	9

Dealing generally with the question of sterility, Leake and Ram Prasad say "Sterility may take various forms. Thus the fruits of flowers fertilized by their own pollen may fail to set, or having set may undergo partial development only and fail to ripen. They may on the other hand produce seed which, when sown, gives rise to plants which are completely or partly sterile."

Discussion.

As a criticism of the position which Leake and Ram Prasad have taken up, the following points may be put forward:—

- (1) The percentage of bolls set on self-fertilization varies from day to day through environmental conditions,

¹ Leake, H. M., and Ram Prasad. Notes on the incidence and effect of sterility and cross-fertilization in the Indian cottons. *Mem. Dept. Agri. Ind., Bot. Ser., IV, No. 3, pp. 37-72.*

and any of the above results which are put down to a diminution of ability to set bolls are explicable on this basis alone. In St. Vincent, the percentage of retained bolls in Sea Island cotton varies from 0 to 95 per cent. on different days according to weather conditions.

- (2) Selfing may result in the isolation of genotypes which are either more resistant or less resistant to shedding conditions than the original heterogeneous population.
- (3) On statistical grounds the above results are inadmissible as evidence.

Kottur¹ compared commercial Kumpta with Kumpta selfed for 6 years and showed that shedding was considerably less in the self-fertilized plants.

INBREEDING AND CONTABESCENCE OF ANTERS.

Leake and Ram Prasad (l. c.) allude to another phenomenon—that of contabescence of anthers, which they believe to have resulted as a consequence of self-fertilization. In 1908, their type 9 (*G. neglectum*) in the third selfed generation showed flowers in which a condition of almost complete sterility was present. The stamens were white and shrivelled, and rarely contained pollen. In 1909, however, the sterile condition of anthers was not so marked.

On the general question of contabescence of anthers there is a considerable body of collateral information which it will be useful to bring together. Kottur (l. c.) notes the occurrence of more or less contabescence of anthers in commercial Kumpta cotton in about 75 per cent. of the flowers. He states that all varieties which have come under his observation are affected. Further, he shows that contabescence of anthers was not increased in Kumpta cotton by 7 generations of selfing, but was in some cases actually reduced. Balls² working with Egyptian cotton notes the presence of more or less contabescence and ascribes it to cold at a critical period

¹ Kottur, G. L. Cross-fertilization and sterility in cotton. *Agri. Jour. Ind.*, 1921, pp. 52-59.

² Balls, W. L. *The cotton plant in Egypt.*

The writer¹ published a short note on the sporadic appearance of a male sterile form in Sea Island strains which had attained practically a homozygous condition through 6 generations of self-fertilization. The rare occurrence of the same form in commercial stocks was also noted. The most striking features of this type, known locally as "man cotton," consisted in the complete absence of pollen from the anthers, which were white and shrivelled, and the presence of a large degree of sterility on the female side, shown by the fact that on one plant over 200 pollinations with normal pollen were unsuccessful, and that in another plant only one boll containing two seeds was produced, presumably as the result of a natural cross.

These two seeds gave rise to two plants entirely normal in appearance. Further observations on the second generation of the cross in January 1921 showed that of 36 plants, not one was like the "male sterile" grandparent. All showed a certain amount of contabescence of anthers but not more than was exhibited (a) by pure lines of Sea Island, (b) by F_1 , F_2 , and F_3 hybrids between pure lines of Sea Island.

The interpretation of the above results is not simple. The occurrence of "male sterile" after 6 generations of selfing falls into line with Jones' observation that it is in the 3rd to 6th generation of selfing that aberrant and semi-sterile forms are most likely to be produced. Up to this time they have been hidden by their dominant allelomorphs.

The distinction between "male sterile" and normal is sharp, and no intermediate grades accompany them in the strains in which they occur. It is thus probable that "male sterile" is due to some peculiarity in genetic composition which would yield to further analysis. Its mode of inheritance is not that of a simple recessive, as shown by its relatively infrequent occurrence, but it may be either a triple or quadruple recessive.

The most likely explanation has its basis in an analogy to the case of "beaded wing" worked out by Muller in *Drosophila*. Here the factor conditioning the appearance of "normal" is linked closely

¹ Harland, S. C. A peculiar type of rogue in Sea Island Cotton. *Agri. News, Barbados* (1920), p. 29.

with a lethal factor, and only comes to light occasionally through a break in the linkage by crossing over. On Muller's hypothesis "male sterile" is analogous to "normal." On the plant side the occurrence of "male sterile" in Sea Island cotton finds its closest parallel in the male sterile *laeta* mutation in *Oenothera lamarckiana*.

It is not improbable that the Sea Island type is in a condition of permanent heterozygosis, the consequence of which is that aberrant types will continue to appear in so-called pure lines through crossing over from lethal factors. The possibility of other commercial cottons being in the same condition should not be lost sight of by the cotton breeder.

ENVIRONMENTAL CONTABESCENCE OF ANTHERS IN WEST INDIAN COTTONS.

In contradistinction to the case of male sterility presented above, contabescence of anthers of a similar type to that described by Balls (l. c.) occurs occasionally in Sea Island cotton, particularly towards the end of the season. In some seasons it occurs but rarely, but when it does so it is not found to a greater extent in pure lines than in commercial stocks.

In the West Indian perennial types which have been described by the writer¹ as an assemblage of elementary species, and which bred true from the time of their introduction into pedigree culture, contabescence of anthers is rare.

THE CAUSES OF EMPTY POLLEN GRAINS.

A summary of the causes leading to empty pollen grains and aborted embryo sacs is given by Belling.² It will be useful to quote his analysis.

He says:—

- "(1) There is a mortality due to accidents of environment; in which case the lethal effect is usually different in different flowers on the same plant, or in different

¹ Harland, S. C. Studies of inheritance in cotton. The inheritance of corolla colour. *West Indian Bulletin*, XVIII, pp. 13-19.

² Belling, J. Lethal factors and sterility. *Jour. Heredity*, 12 (1918), pp. 161-165.

plants of the same homozygous line, or at different times of the year . . . This mortality is apparently not selective and presumably does not affect the ratios of zygotes.

- “(2) There is a partial mortality of pollen grains due to zygotic factors, which factors I have found cause the death of usually a small fraction of the pollen grains in certain fertile and semi-fertile lines from *Stizolobium* crosses. This tendency is inherited, but is apparently not selective.
- “(3) The whole, or nearly the whole, of the pollen of a plant may perish by the action of zygotic factors, as in the sweet pea with empty anthers. In these cases the abortion is not selective.”

Of the cases which have been discussed, contabescence of anthers is mostly to be placed in Belling's group 1. The "male sterile" Sea Island form falls into group 3. It is probable that certain forms of pollen grain abortion in cotton fall into group 2, but it would not be possible to state this with certainty unless the environmental effect were carefully eliminated.

STERILITY OF OVULES.

In all the cottons examined by the writer, whether self-fertilized or open pollinated, a certain percentage of the ovules fail to develop. Kottur (l. c.) has also noted this feature in Indian cotton. Possibly inadequate pollination is responsible for the non-development of some ovules.

A summary of the information available on this point is as follows :—

- (1) A certain percentage of undeveloped ovules is found in all varieties of cotton examined. These include native West Indian perennials, pure Sea Islands, commercial Sea Islands, Upland, and Egyptian.
- (2) Second generation segregates from crosses between widely different sorts, e.g., Sea Island \times native West Indian, are often characterized by a large percentage of

undeveloped ovules. This may be due to inability of the pollen to fertilize as a consequence of some morphological peculiarity in flower structure. The extreme case was a segregate whose stigma was buried in the column. Other causes of failure of ovule development may rest in competition between ovules for food supply, or may have a genetic basis, involving gametic incompatibility, or action of lethal factors preventing development of the embryo sac.

- (3) No greater percentage of ovule sterility is found in pure lines than in cross-bred sorts.
- (4) Pure lines differing constantly in percentage of undeveloped ovules can be isolated by self-fertilization.

SUMMARY.

(1) The conclusions of Leake and Ram Prasad on the evil effects of inbreeding in cotton need revision in the light of recent genetic investigations. Their cases of alleged reduction in fertility as measured by the ability of selfed plants to set bolls are discussed, and it is pointed out (a) that the results are not statistically significant, (b) that the neglect of environmental causes of shedding preclude the data from being accepted for critical purposes.

(2) The appearance of a partial degree of male sterility in Leake's cultures is brought into line with observations made by other workers, and it is thought that the cases of contabescence observed by him are either of the environmental type or due to the segregation of lethals.

(3) A case of complete "male sterility" in Sea Island cotton is considered as due to genetic causes.

(4) Continued inbreeding has not been found to result in progressive diminution in fertility as measured by percentage of ovules set, either in Sea Island (Harland) or Kumpta (Kottur). On the contrary, it is clear that inbreeding may result in the isolation of types more resistant to shedding than the commercial ancestors.

(5) Continued inbreeding does not necessarily lead to sterility as measured by abortion of pollen grains, for such abortion is not more frequent in elementary species or pure lines than in commercial stocks or first generation hybrids.

(6) The position of cotton when homozygous is analogous to homozygous lines of maize, or to pure lines of a normally selfed crop such as the garden pea. Inbred lines of cotton are in no way distinguishable from commercial stocks except in a reduction of general vigour which is usually slight and of little consequence to those engaged in cotton breeding.

ON THE PROBABLE ERROR IN VARIETY TRIALS WITH PADDY.*

BY

B. N. SARKAR, L. AG.,

Assistant Director of Agriculture, Chota Nagpur Circle, Ranchi.

PADDY being the main crop in most parts of India has, of late, received considerable attention from the various Agricultural Departments, the object being chiefly to find out varieties that will give the maximum yield to the cultivator under his conditions. In such work it frequently becomes necessary to compare together or with a chosen "standard" a large number of varieties. Accuracy is essential in such work, and any method either of laying out the experimental plots or of interpreting the results which leads to increased accuracy is therefore of considerable value. Much has been written about the estimation of "probable error" in valuating the results of field experiments. But the usual methods of estimating the probable error appears to lead to serious under-estimation of the results under certain field conditions which are by no means of unusual occurrence. A study of the problem by different ways of looking at the results may, therefore, be of interest.

There are innumerable factors that affect the yield of paddy. These may be placed under two categories, *viz.*, those that are internal to the plant and those that are external. The internal factors are responsible for the purely varietal differences in yield between the different varieties, and it is the object of variety trials to clearly bring out this difference. This implies that the external factors should remain constant for all the varieties under trial. But this becomes impossible in practice under most field conditions.

First of all it is impossible to get land of even fertility. A field which appears approximately uniform from the growth of a

* Paper read at the Indian Science Congress, Lucknow, 1923.

standing crop shows large variation when harvested and weighed in small plots. But generally we cannot get even seemingly uniform land. In the particular case to be discussed later there was a difference of about 40 per cent. in yield between one end of the field and the other. It may easily be understood that this order of difference in fertility of the land may quite obscure the results of most quantitative experiments.

Then again there are many other factors that induce error in field experiments. If the land is not evenly puddled and levelled, which has to be done before planting, the land is left in humps and hollows, and these may affect the different varieties in different ways. Blanks are sometimes caused by planting weak seedlings. Heavy showers may burst the "ails" and wash away a lot of the plants near the breach. Animals such as crabs, rats and birds sometimes damage portions of the crop. There may be mistakes in harvesting, threshing or weighing. It is the occurrence of large accidental errors of this kind that may upset the results of experiments. But such errors may be considerably reduced if the experiment is carefully supervised. What cannot be controlled are the small variations of the above factors and the comparatively large variation in the fertility of the land.

Mr. Dobbs drew attention to the very bad effect of variation in soil fertility on the results of experiments involving the comparison of yield of crops as early as in 1911.¹ To discount such variations he suggested that the experimental plots compared should be as long and as narrow as practicable and along side of one another, "on the obvious principle that while small local variations in the fertility of the soil will be neutralized by one another to an extent proportional to the size of plots, any large general variation is likely to be gradual and continuous, and that therefore the probable normal difference of fertility between two small adjoining plots will vary more or less directly as the distance between their centres, *i.e.*, as their breadth." The result of the experiment might in fact be interpreted with the aid of fertility

¹ *Agri. Jour. Ind.*, VI, Pt. 1.

curves drawn by testing the fertility of the land before starting the experiment, as also by putting normally treated "controls" in every alternate plot throughout the experimental field. He showed how otherwise misleading results could be discounted by means of these fertility curves.

Since then a considerable literature has grown up abroad about the estimation and value of probable errors in field experiments. In India, Mr. Parnell, working with paddy, showed that under the conditions of his trials on carefully selected land, plots 50' × 4' gave a little more than 2 per cent. probable error of the difference between any two strains, when any number up to 8 strains were included in any one series, each strain being repeated 8 to 12 times according to the size of the field.¹

The above principles were followed in laying out the experimental plots for paddy variety trials at the Kanke Farm last year. The fields were recently levelled and were known to be not at all uniform in fertility. One of these fields, 80' in width, was divided into sixty 4' wide plots running across the entire width of the field with an 18" space between every two plots, thus making the experimental plots as long and as narrow as practicable. Six varieties—all flowering within a fortnight—were included in the series, and were planted in a recurring series, each being repeated ten times. The seeds for these were obtained from "pure lines" and were grown separately. The spacing was not done accurately but equal number of lines were planted in every strip laid out by strings. Single seedlings were planted throughout. The plan of the experimental plots and their yields in *tolas* (40 *tolas* = 1 lb.) are given below:—

TABLE I.

					<i>Tolas</i>
1	Indrasal	795
2	C. P. Lochai	857
3	Dudhsar	1,008
4	No. 26	1,080
5	No. 51	1,057
6	Kalamdan	867
7	Indrasal	773
8	C. P. Lochai	808
9	Dudhsar	935

¹ *Agri. Jour. Ind.*, XIV, Pt. 5. 9

TABLE I—*concl.*

						<i>Tolas</i>
10	No. 26	998
11	No. 51	1,045
12	Kalamdan	893
13	Indrasal	830
14	C. P. Lochai	763
15	Dudhsar	875
16	No. 26	900
17	No. 51	985
18	Kalamdan	920
19	Indrasal	780
20	C. P. Lochai	710
21	Dudhsar	805
22	No. 26	833
23	No. 51	1,000
24	Kalamdan	742
25	Indrasal	775
26	C. P. Lochai	635
27	Dudhsar	828
28	No. 26	830
29	No. 51	988
30	Kalamdan	830
31	Indrasal	685
32	C. P. Lochai	980
33	Dudhsar	825
34	No. 26	902
35	No. 51	827
36	Kalamdan	738
37	Indrasal	675
38	C. P. Lochai	914
39	Dudhsar	768
40	No. 26	788
41	No. 51	831
42	Kalamdan	786
43	Indrasal	672
44	C. P. Lochai	905
45	Dudhsar	695
46	No. 26	790
47	No. 51	755
48	Kalamdan	650
49	Indrasal	615
50	C. P. Lochai	848
51	Dudhsar	640
52	No. 26	745
53	No. 51	883
54	Kalamdan	650
55	Indrasal	567
56	C. P. Lochai	625
57	Dudhsar	600
58	No. 26	640
59	No. 51	680
60	Kalamdan	625

It may be seen from the above table that there is a large amount of variation in yield of the same varieties in different parts of the field. It may also be seen that No. 51 gave higher yields than the nearest plots of Dudhsar and Kalamdan in every case, and 9·7 per cent. and 12 per cent. more respectively on the means. These differences ought to be enough to clearly establish the superiority of No. 51 over Dudhsar and Kalamdan. But if the relative positions of the plots be ignored and the difference of their means is judged by its probable error given in Table II below, the results might not be considered decisive.

TABLE II.

Name of variety	Mean yield of 10 plots in <i>tolas</i>	Probable error of mean	Co-efficient of variability	Difference between the mean of No. 51 and the mean of—	Error of difference	Ratio of difference to error	REMARKS
Indrasal ..	716·7	± 8·42 or 2·57 %	11·4 %	168·4 or 19 %	± 35·12	4·8 : 1	Indrasal definitely inferior.
C. P. Lochai	804·5	± 25·57 or 3·47 %	14·1 %	80·6 or 9·1 %	± 40·17	2 : 1	Not sufficiently conclusive.
Dudhsar ..	797·9	± 27·2 or 3·4 %	16·4 %	87·2 or 9·7 %	± 41·31	2·1 : 1	Do.
No. 26 ..	850·6	± 26·92 or 3·16 %	14·0 %	34·5 or 3·9 %	± 41·12	1 : 1·2	Difference insignificant.
No. 51 ..	885·1	± 34·41 or 3·5 %	15·7 %
Kalamdan..	778·1	± 21·26 or 2·7 %	12·2 %	107 or 12 %	± 37·12	2·6 : 1	Not sufficiently conclusive.

Note. The percentage in all cases has been calculated on the mean yield of No. 51.

The above results so estimated are very disappointing as no varieties but Indrasal, which was decidedly too late for the land, seemed to be decisively eliminated. But in view of the more conclusive results of simple comparisons of the adjoining plots it was clear that a very large part of the error was due to variation of fertility and could be discounted by an appropriate modification of the usual statistical method of comparison.

In arriving at the results in Table II the mean yield alone had been taken into consideration, entirely disregarding the arrangement of the plots. The whole yield under each variety was in effect bulked together, and, had it not been necessary to work out the probable errors, it would have been more accurate to bulk them

at harvest so as to avoid errors in threshing, drying, weighing, etc. The object of having narrow adjoining plots is, however, to diminish the effect of any continuous variation in fertility of the land, for, when the individual differences are worked out from the actual yields of a pair of narrow plots lying alongside each other, these differences, owing to their being derived from within a narrow strip, are practically independent even of very large continuous variations of fertility. The probable error of the mean of these differences is therefore likely to be relatively small. This brings us back to the suggestion of Mr. Dobbs quoted above that the "control" or "standard" should be grown in every alternate plot. As an illustration of this the result of a trial consisting of only two varieties—Early Indrasal and Kalamdan—are given below. This series was also tried in the same land as the other series given in Table I. The plan of the experimental plots with their yields and differences between each pair of plots in favour of Kalamdan shown as + are given in Table III. The yield of individual plots and the differences are given in *tolas*.

TABLE III.

Name of variety			Yields and differences between each pair of plots in <i>tolas</i>	
Early Indrasal	670
Kalamdan	703
				} + 33
Early Indrasal	630
Kalamdan	705
				} + 75
Early Indrasal	560
Kalamdan	653
				} + 93
Early Indrasal	615
Kalamdan	640
				} + 25
Early Indrasal	542
Kalamdan	700
				} + 158
Early Indrasal	667
Kalamdan	715
				} + 48
Early Indrasal	702
Kalamdan	647
				} - 55
Early Indrasal	750
Kalamdan	848
				} + 98
Early Indrasal	758
Kalamdan	918
				} + 160
Early Indrasal	830
Kalamdan	870
				} + 40

Table IV shows the result of comparison when the difference between the two means is measured by its probable error.

TABLE IV.

Name of variety	Mean yield of 10 plots in <i>tolas</i>	Probable error of mean	Co-efficient of variability	Difference between the two means	Probable error of difference	Ratio of difference to error	REMARKS
Kalamdan ..	739.9	± 21.5 2.77%	12.9 %	67.5 or 9.1 %	± 28.5	2.4 : 1	Not sufficiently conclusive.
Early Indrasal	672.4	± 19.33 2.87%	12.7 %				

The result arrived at is not sufficiently conclusive though Kalamdan gave higher yields in 11 cases out of 12 and 9.7 per cent. more on the average. Table V shows the result of comparison when the mean of the differences between pairs of adjoining plots is compared with its probable errors. The result thus arrived at is more what was expected from the number of differences in favour of Kalamdan.

TABLE V.

Difference of 10 pairs of plots in favour of (+) or against (-) Kalamdan	Mean difference	Prob. error of mean difference	Ratio of mean difference to error	REMARKS
+33 +75 +93 +25 +158 +48 -55 +98 +160 +40	67.5 or 9.1 %	± 14.1	4.8 : 1	Kalamdan definitely superior.

But when 6 or 8 varieties have to be tested for yield, which becomes imperative in dealing with crops like paddy in which a large number of varieties have to be dealt with, the system of growing the standard in every alternate plot takes much more land, which is not always available, and also much more care and trouble in

harvesting, weighing, etc., than the system shown in Table I. So the former must be avoided if possible. At the same time it is not possible to subject the results of Table I to the same treatment as in the case of Table V to bring out the true significance of the difference between any two varieties which are not alongside each other, because the difference in fertility between any plot of Indrasal and the nearest plot of, say, No. 51 may be considerable on account of the distance between them, and the error due to this cause alone may be large.

The difficulty can, however, be overcome in the following manner. Any of the varieties may be taken as a standard. The yield that this would have given in each plot is estimated by dividing the actual yield of the variety grown on that plot by the mean for that variety and multiplying the quotient by the mean of the standard, and is marked to any scale on the central line of the plot on a diagram of the plots. Then a curve (Plate XVI) showing the estimated variation of fertility is drawn across the plots, the curve being smoothed out between the points marked. Then the actual yield of each plot of each variety is marked by any convenient mark across the plot and the difference between that actual yield and the estimated yield of the standard variety in the same plot as determined by the area between the mark and the curve is measured. The results are then treated as if they represented the actual difference of yield in each plot from that of a corresponding standard plot—the mean of these differences and error of the difference being calculated as before. Plate XVI combined with Table VI shows the results as calculated on the above lines and may be compared with Table II giving the results as calculated without reference to the arrangement of the plots. No. 51 is taken as standard in both cases and the percentage difference is calculated on the mean yield of the estimated No. 51.

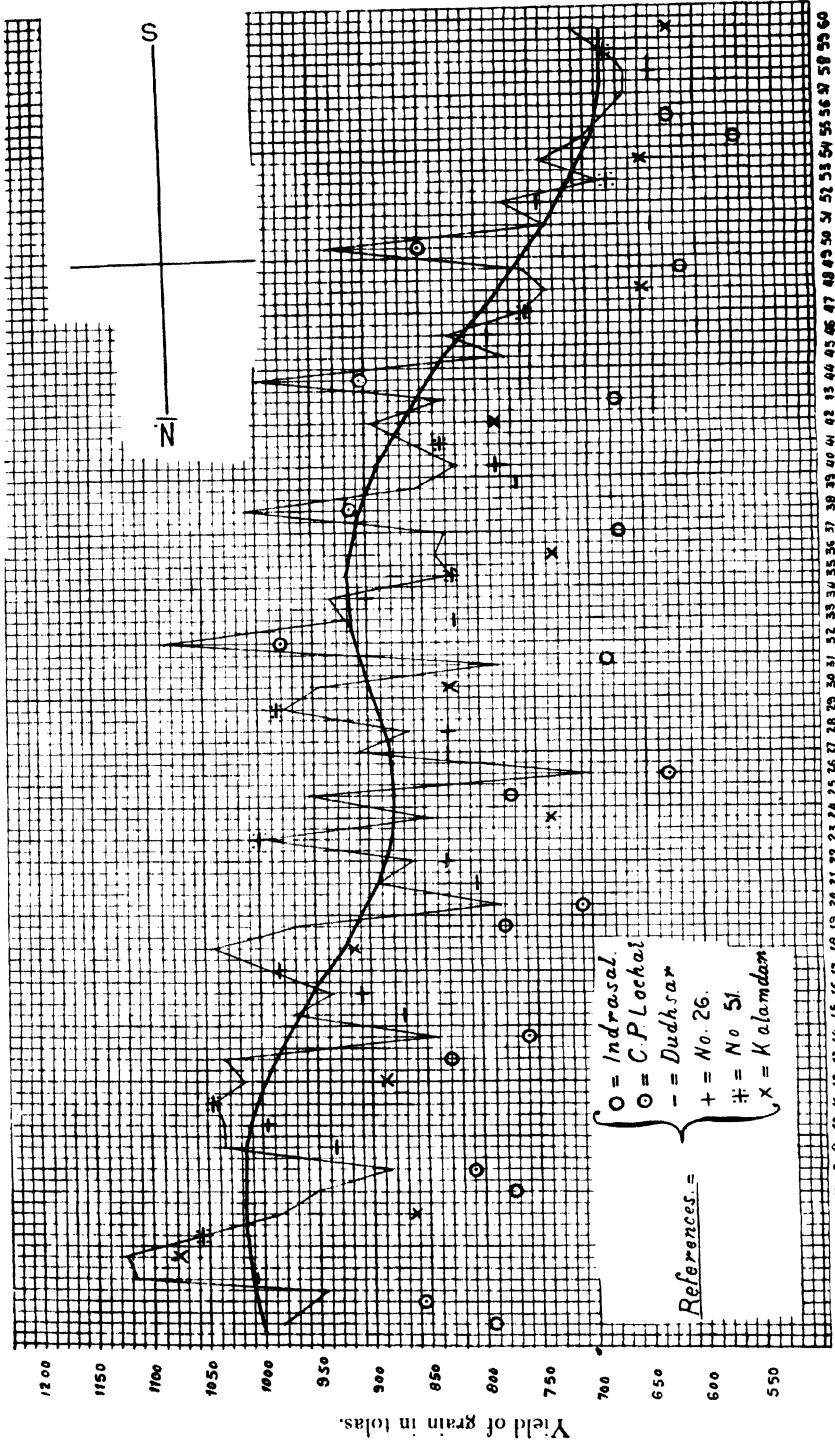

ESTIMATED YIELD CURVE FOR PADDY No. 51.

Plot Nos.

TABLE VI.

Name of variety	Difference of yield of ten plots of each variety in favour of (+) or against (-) No. 51 (estimated) in <i>totas</i>										Mean difference	Probable error of mean difference	Ratio of difference to error	REMARKS
Indrasal ..	+207 +242 +188 +185 +103 +220 +236 +181 +150 +128	+176 or 19.7%	±10.35	17:1	No. 51 definitely superior.									
C. P. Lochai ..	+148 +207 +202 +193 +245 -68 -9 -65 -98 +65	+ 83 or 9.3%	±28.54	2.9:1	Not sufficiently conclusive, due probably to some accident in the Lochai plots in the middle making the probable error too large.									
Dudhsar ..	+2 +75 +90 +90 +54 +90 +131 +130 +94 +87	+ 84.3 or 9.52%	±7.88	10:1	No. 51 definitely superior.									
No. 26 ..	-68 +10 +52 +55 +58 +15 +102 +18 -17 +42	+ 26.7 or 3.0%	±9.98	2.7:1	Not conclusive.									
No. 51 (actual) ..	-45 -43 -45 -120 -98 +93 +49 +40 +32 +0	- 13.7 or 1.5%	±15.79	1:1.2	No difference.									
Kalamdan ..	+145 +107 +5 +138 +66 +176 +82 +122 +55 +60	+ 95.6 or 11.0%	±10.95	8.7:1	No. 51 definitely superior.									

It will be seen from the above figures that the varieties can be compared by statistical methods with some assurance down to a difference of 9 per cent. on the yield by discounting variations in fertility which would otherwise make the errors too large. In another series of trials consisting of 8 varieties a difference of 7 per cent. between the two means proved to be significant when compared on the above lines.

The above method is really an extension of the principle of comparing adjacent plots. Instead of comparing actual yields of two adjacent plots we compare the actual yield of each plot with an estimated yield of a standard variety on the same plot. There is, however, one objection to it that the estimated yield of any plot may be unnecessarily magnified or reduced unless the variety selected as standard for making the curve happens to have been grown on plots that give an unusually accurate index of the variation in fertility of the field. This difficulty might be got over by the method of successive approximation, taking any of the other varieties, say Dudhsar, as standard for a revision of the curve in Plate XVI.

But it was thought that a sounder method would be to plot the fertility curve by taking the mean of each consecutive six plots as representing fertility at the point in the centre of the six—*i.e.*,

$$\frac{A_1 + B_1 + C_1 + D_1 + E_1 + F_1}{6} \text{ represents fertility between } C_1 \text{ and } D_1$$

$$\frac{B_1 + C_1 + D_1 + E_1 + F_1 + A_1}{6} \quad \text{,,} \quad \text{,,} \quad \text{,,} \quad D_1 \text{ and } E_1$$

and so on. This value is expressed as a percentage of the mean of all the values thus arrived at, or, in other words, of the "mean fertility." The value for the three plots at either end cannot be obtained in the above way but can be calculated in terms of the mean fertility in proportion to the actual and mean yields of the variety actually grown on each of these end plots. Then a curve is drawn by plotting all these values, the curve being smoothed out as before (Plate XVII). For convenience of reference this curve is called the "normal fertility curve" or simply "normal." Now the actual yield of each plot under each variety—expressed also as a percentage of the mean fertility—is compared against the normal on that plot.

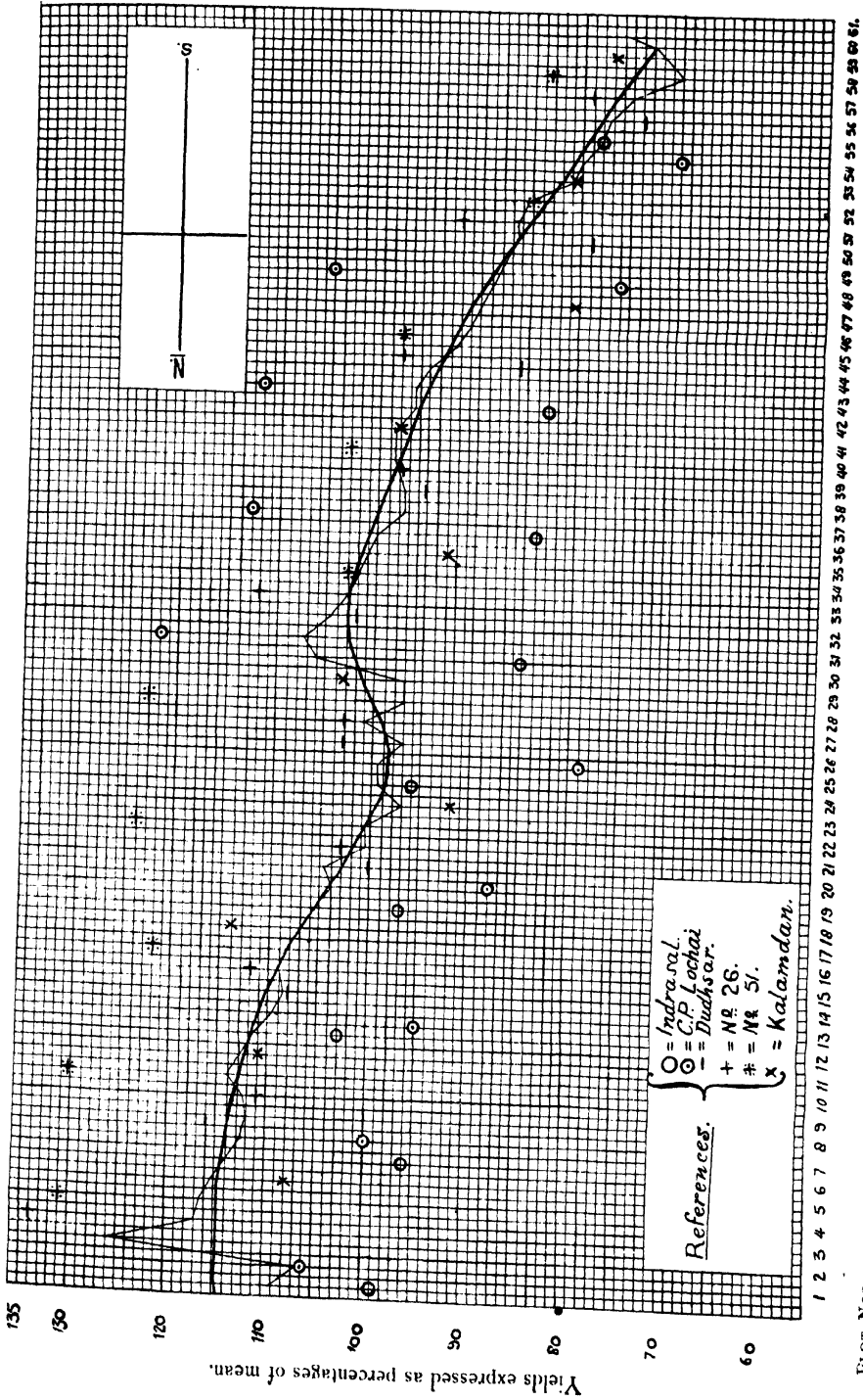

NORMAL FERTILITY CURVE.

The percentage differences are then averaged and the probable errors worked out as before. Table VII gives the mean percentage differences and probable errors as calculated by this method.

TABLE VII.

Name of variety	Percentage difference of 10 pairs of plots in favour of (+) or against (-) "normal"										Mean difference in percentage	Probable error of mean difference to error
Indrasal ..	+16	+18	+8	+9	+2	+17	+17	+13	+13	+9	+12.2	±1.09
C. P. Lochai ..	+9	+14	+15	+16	+19	-19	-13	-17	-17	+1	+ 0.8	±3.35
Dudhsar ..	-10	+2	+1	+3	-4	+1	+4	+8	+7	+4	+ 1.6	±1.12
No. 26 ..	-9	+2	-3	0	-4	-9	+1	-5	-7	-2	- 4.6	+1.31
No. 51 (actual)	-16	-17	-14	-24	-23	-1	-5	-6	-1	-8	-11.5	±1.81
Kalamdan ..	+6	+6	-7	+7	-1	+8	-1	+10	+1	-2	+ 2.2	±1.14

From these differences and probable errors we can now compare any variety direct with our original standard No. 51, the percentage difference between the standard and each of the other varieties being worked out by simple calculation on the basis of the normal, and the error of the difference being arrived at by averaging the two errors and multiplying the average by $\sqrt{2}$. The results are given in Table VIII below.

TABLE VIII.

Name of variety	Difference in percentage	Error of difference	Ratio of difference to error	REMARKS
No. 51 vs. Indrasal ..	21.2	± 2.04	10.4 : 1	No. 51 definitely superior.
No. 51 vs. C. P. Lochai	11.0	± 3.64	3 : 1	Do.
No. 51 vs. Dudhsar ..	11.7	± 2.07	5.7 : 1	Do.
No. 51 vs. No. 26 ..	6.2	± 2.20	2.8 : 1	Not sufficiently conclusive.
No. 51 vs. Kalamdan	12.6	± 2.07	6 : 1	No. 51 definitely superior.

It will be seen from the above Table that the results give similar conclusions as were reached from Table VI.

The instances dealt with in this paper show that variation of fertility of the land may so affect the yield figures of paddy that the results of comparative variety trials may be underestimated or overestimated unless particular care is taken in their interpretation. The probable error certainly forms the basis of the value of such results, but a large part of this error may sometimes be due to variation of soil fertility which should be discounted, as far as possible, by appropriate means. So far as the estimation of probable error—and for that matter the accuracy of the results—is concerned, the effect of this variation can be reduced to minimum by reducing the distance between the centres of the experimental plots to 4', and by comparing only plots lying alongside of one another. Greater accuracy is obtained by looking at the results not in lump, *i.e.*, the mean, but in the details of which the mean is composed. That is why we see in Tables IV and V that a number of detailed comparisons gave greater accuracy than a lump comparison of the mean of these details. But a direct comparison of adjacent plots is not always practicable, particularly when a large number of varieties have to be dealt with. This can, however, be indirectly done as shown in Tables VI and VIII. Of these two methods the latter is thought to be the more accurate as it gives smaller errors on the mean differences with the "normal" as shown in Table VII, though for final comparison in Table VIII the errors became comparatively larger owing to their being multiplied by $\sqrt{2}$; but that keeps us on the safe side. It will however require further tests to establish the relative accuracy of one or the other of these two methods, and interesting results are expected from this year's trials.

Lastly, I beg to express my gratitude to Mr. Dobbs and to Mr. A. P. Cliff, my superiors in office, for many valuable suggestions in the preparation of this paper.

THE OPERATIONS AGAINST THE BUD-ROT OF PALMYRA PALMS ON THE EAST COAST.*

BY

W. McRAE, M.A., B.Sc.,
Offy. Imperial Mycologist.

BUD-ROT is a disease of palms in Eastern and Southern India. On the palmyra it is found in the Hooghly District of Bengal, in Kistna and Godavari Districts on the east coast and in Malabar District on the west coast of the Madras Presidency, while on the coconut palm it occurs in Godavari District and on the west coast from South Kanara through Malabar and Cochin to Travancore. The first symptoms of the disease are the central leaf or group of leaves becoming pale and dying or one or more rows of spots appearing on the green blades of the leaves. When the crown is dissected, spots, usually from one to six inches in diameter, are found on the leaf-stalks and on successive leaf-bases towards the soft part of the stem ; the bud is rotten and in advanced cases emits a nauseous smell. The disease is said to have arisen in an island of the Godavari river about 1890 and to have increased till it assumed epidemic form and attracted the notice of the Agricultural Department in 1905. Next year Dr. Butler¹ determined the primary cause to be the fungus *Phytophthora palmivora* and suggested measures to combat the disease. The main point of the suggestion was the formation of a special staff under whom would work groups of palm climbers who would cut off the crowns of dead palms and burn them.

The following is an account of the operations that were initiated in the Godavari and Kistna Districts against this disease on palmyra palms. In December 1906, trial measures were begun on a small

* Paper read in the Botanical Section of the Indian Science Congress, January 1923.

¹ Butler, E. J. Some Diseases of Palms. *Agri. Jour. Ind.*, Vol. I, p. 299. The Bud-rot of Palms in India. *Mem. Dept. Agri. Ind., Bot. Ser.*, Vol. III, p. 221.

scale in a part of the infected area to gain experience and to see whether the measures were practicable, for there was some doubt and hesitation in undertaking remedial measures on the large scale that was obviously required. The crowns of 40,000 dead palms were cut off and burned, and it became evident that the difficulties, though great, were not insurmountable. Accordingly in June 1907 operations on a larger scale were begun in Amalapur Taluk, that part of the Godavari delta between the two main branches of the river. Four parties of tappers, who alone could climb the palms, were organized under three mycological assistants and an agricultural demonstrator. They went from one end of the selected area to the other and during 1907 cut 175,229 dead palms. The work was then extended into Ramachandrapur and Cocanada Taluks and 183,100 dead palms were dealt with during 1908. It was found however rather unexpectedly that, very soon after all the dead trees in a village had been cut, new cases appeared in considerable numbers and the staff had to be brought back to deal with them. Thus during 1907 and 1908 Amalapur Taluk was completely worked over three times. It thus became obvious that the interval between infection and the appearance of outward symptoms of disease was longer than was anticipated, and that consequently this method with the staff as sanctioned then could not cope with the disease. The changes in staff were also a difficulty as the mycological assistants could not be spared for long and the revenue inspectors who replaced them were frequently changed. Besides, only a part of the infected area was being dealt with. From October 1908 accordingly a new system was introduced whereby actual cutting and burning was to be carried out by the tappers and village servants under the direction of the village officers upon whom was thrown the responsibility for getting the work done. The members of the special staff thus relieved became inspecting officers. This was the aim of the new system, but only gradually did it take effect in practice, and not till 1920 when the Pest Act was applied was it fully realized. Another great improvement was the fact that the whole of the infected area in Godavari was brought under operation at the end of 1908 and that of Kistna in 1910.

While the village officer was moving about the village on revenue duty, he noted the position of dead trees and arranged to have them cut. At first the trunks were marked with paint, but as the marks were obliterated by weathering, registers were maintained from 1914 showing the survey number of every field in which disease was found, and each month the numbers of diseased palms cut were entered in the appropriate places. The revenue inspectors checked the number of headless palms in the fields, noted all trees that had been missed and had them cut, and also paid the cutting charges which at different times varied from $\frac{1}{4}$ to $1\frac{1}{2}$ annas per tree. The difficulties of introducing an entirely novel and little appreciated method of dealing with a disease were very real and required patient, continuous effort to overcome. Gradually as the years passed, the work was better done and the tree-owners were even induced to bear the cost of cutting and burning, thus showing that they did come to have some belief in the operations, and from 1915 onwards the cost of the special staff was practically all that fell to be charged to Government funds.

The record of the numbers of diseased palms dealt with annually during the fifteen years the operations have been in existence is given in the table on p. 490.

For the sake of convenience in recording the figures the diseased palms were divided into three categories corresponding somewhat to the symptoms of the disease, viz., (1) *dead palms* in which the central leaf or group of leaves was dead indicating that the growing-point was dead, (2) *outwardly infected palms* in which one or more of the leaves had characteristic rows of spots indicating that the growing-point was still alive, and (3) *inwardly infected palms* in which the presence of the disease was detected by stripping the leaf-base from palms that showed no outward symptoms of disease but that grew in the vicinity of dead or outwardly infected palms. Classified in this way, the numbers gave information as to the progress of the operations, inasmuch as the outwardly infected and inwardly infected trees were given a chance of recovery because all their diseased tissue was excised.

Neu palmyra pal cut ann Uly.

Year	GODAVARI DISTRICT					KISTNA DISTRICT					TOTAL				
	Inwardly infected	Outwardly infected	Dead	Total		Inwardly infected	Outwardly infected	Dead	Total		Inwardly infected	Outwardly infected	Dead	Total	
1907	215,229	215,229	215,229	215,229	
1908	183,100	183,100	183,100	183,100	
1909	91,849	91,849	91,849	91,849	
1910	58,765	58,765	15,561	15,561	15,561	74,326	74,326	
1911	67,921	67,921	10,466	10,466	10,466	78,387	78,387	
1912	72,345	72,345	7,107	7,107	7,107	79,452	79,452	
1913	..	19,088	55,204	74,292	..	3,122	3,265	6,387	6,387	..	22,210	22,210	58,469	80,679	
1914	570	38,765	32,842	72,177	4,792	2,347	3,515	10,654	10,654	5,362	41,112	41,112	36,357	82,831	
1915	5,733	23,379	21,847	50,959	6,629	673	721	8,023	8,023	12,362	24,052	24,052	22,568	58,982	
1916	41,337	11,791	25,133	78,261	1,830	711	1,696	4,237	4,237	43,167	12,502	12,502	26,829	82,498	
1917	12,286	8,370	19,873	40,529	1,662	882	2,497	5,041	5,041	13,948	9,252	9,252	22,370	45,570	
1918	12,837	11,529	20,987	45,353	4,080	2,616	4,488	11,184	11,184	16,917	14,145	14,145	25,475	56,537	
1919	7,517	7,717	15,860	31,094	665	703	975	2,343	2,343	8,182	8,420	8,420	16,835	33,437	
1920	14,892	14,892	1,616	1,616	1,616	16,508	16,508	
1921	7,349	7,349	1,343	1,343	1,343	8,692	8,692	
TOTAL	80,280	120,639	903,196	1,104,115	19,658	11,054	53,250	83,962	83,962	99,938	131,693	131,693	956,446	1,188,077	

During 1907 and 1908 a considerable number of the dead trees cut were "old cases" that had died in previous years, so probably the number that died in 1908 was about 100,000 and the 91,849 cut in 1909 all died that year. From 1910 to 1912 the number of trees that died annually over the whole area was fairly constant (from seventy-four to seventy-nine thousand) and considerably below the previous figures for Godavari District alone. Attention was given to getting the work done punctually as soon as symptoms appeared and to extending the area of operations to embrace all outlying infected villages. In 1913 the number of dead palms dropped to 58,469, and there could be no doubt that the method of cutting and burning dead crowns was having an influence in lowering the mortality due to the disease. Still the reduction seemed too slow, and an endeavour was made to deal with diseased trees before they died.

A fairly large number of palms showed the presence of the disease in the appearance of a row of spots on the green blade of a leaf. Such palms lived for upwards of three and a half years before the central group of leaves died and the tree would be dealt with during the ordinary course of the operations. All this time the fungus could be spread from them to their healthy neighbours. It was found that when such a leaf protruded from the bud and began to open, the mycelium developed on the surfaces of the spots and produced sporangia in favourable circumstances such as when there was dew in the cold season or a highly moisture-charged atmosphere during the monsoon. In the presence of water, the sporangia discharged zoospores freely, and their position on the topmost leaf of the palm was an excellent one for dissemination by dripping on the supporting palm or to lower ones or by rain splashing the zoospore-charged drops of water on the leaf to surrounding palms.

It was also found that when the fungus was penetrating the bud, which is from one to two feet in length, about the level of the growing-point, the base of the expanding leaf was penetrated and its tissue destroyed, resulting in the leaf withering and presenting the usual symptoms of disease, and as the fungus was in the vicinity of the growing-point the latter's death occurred within a short time.

But when the fungus was penetrating the bud at a higher level, the folded lamina of a young leaf was penetrated, and as it was developing actively it soon pushed out into the air and expanded, presenting the symptom of disease consisting of a row of characteristic spots on the expanded leaf-blade, and seeing the fungus was at a sufficient distance from the growing-point, all the diseased tissue of the bases, stalks and blades of the leaves could be cut off leaving a mass of truncated leaves around the living growing-point. It was found by trial in several villages in different parts of the infected area, both in the delta and the uplands, that in any season, if this mass of tissue was four inches broad and six inches high, the growing-point would not die but would in ninety-four per cent. of cases produce a new crown of leaves which in two years or more would be as large as the original crown. As soon as it became apparent that this kind of thing could be done, I tried the experiment on every occasion I could persuade the owner to allow me to operate on a case, and as these cured trees began to multiply throughout the area, people began to see that there was some real tangible benefit in such an operation. So it became possible to have these trees treated, and from February 1913 in Kistna District and July of the same year in Godavari District they were definitely included in the scope of the operations.

We wished now to deal with diseased palms at an earlier stage, even before outward symptoms appeared, so experiments were made wherever possible in examining apparently healthy palms in the vicinity of dead and outwardly infected ones by cutting off leaf-bases, and it soon became apparent that a very considerable number that showed no outward symptoms were diseased. Two examples will suffice. In September 1910 at Vijheswaram, where dead trees had persistently appeared during the year, twenty-one were examined that all looked quite healthy : indeed the tapper said it was useless to climb them looking for disease. Ten had the disease, seven having living fungus and three dead fungus. The seven had 8, 9, 15, 22, 24, 25 and 29 leaf-bases spotted respectively, and the three had 2, 3 and 7 respectively. At Jagapetinagaram 203 dead trees were cut after

the disease was discovered there early in 1912. In October 584 healthy looking palms in the immediate vicinity were examined and 99 of them were diseased. These palms were not being touched by the operations till after a longer or shorter period they showed the outward symptoms. It was found from the records that if seventeen leaf-bases were removed from full-grown trees ninety-four per cent. of the diseased trees would be discovered. Of course the number of leaf-bases on a palm depends on how often they are removed for economic purposes and how many are required at a time, and it varies from tree to tree and field to field. Accordingly from any palm that he was examining the tapper removed seventeen leaf-bases or if that number was too great then sufficient till the thickness of the bud at the lowest leaf-bases was equal to that of the trunk immediately below. From trials made here and there in the delta and uplands on comparatively few trees at a time it became apparent that trees so cut would recover perfectly. What remained to be done now was to get information of the result of such an examination on a large scale. It was naturally difficult to get a sufficient number of ryots in any one large area altruistic enough to let us cut their palmyras so drastically as an experiment, though many individuals were willing enough in different localities and to all of them we owe a debt of gratitude for so enabling us to carry out the experimental part of the work. However in 1914 we got the opportunity in the villages of Chikkala and Unagatla which are situated on the edge of the palmyra belt in the Kistna uplands where there is a great trade in sweet toddy for making *jaggery* for the sugar factory at Samalkota. Since the detection of the disease here in 1912 the number of the dead trees had steadily risen and the infected area had increased to 1,059 acres. Great numbers of tappers migrated into this region annually from the central delta for the tapping season from March to June, and it is possible they brought the disease with them. At any rate their operations helped the disease to spread, as the trees were so often handled and the tappers did not distinguish between infected and healthy palms in tapping. It was obvious that the extension of the disease into this belt would cause greater loss

economically than in any other part of the area, and that the operations here should be carried out more intensively. So great had been the opposition to the treating of outwardly infected palms in these two villages in 1913, that the Collector again suggested legislation to give authority to combat the disease; however Government was unwilling to resort to special legislation till the need for it was much more apparent. After a great deal of hard work in the villages the special Tahsildar got a certain number of them done, and towards the end of 1913 the Collector directed the excise officers not to issue any tapping licenses during the coming season for trees situated in the infected area of these villages. At the beginning of the season in 1914 the agricultural and the special officers concerned with the operations visited the villages and pointed out to the villagers that the disease was steadily spreading and would soon be into the heart of their tapping area, and that its progress could be checked if only they would co-operate in working against it instead of opposing the operations. It was consequently agreed that, if the villagers would cut and examine 17 leaf-bases from all the big trees and operate at once on all those found to be either inwardly or outwardly infected, then the prohibition would be withdrawn. To supervise the work all four Kistna revenue inspectors were concentrated in the two villages while the work was in progress, and an excise officer too remained to issue licenses as soon as trees were ready. Work was finished before the tapping season really set in and tapping on trees known to be healthy proceeded. The result of the examination was as follows :—

Number of palms examined	Found to be diseased but with no external symptoms	Found to be diseased and showing external symptoms	Found to be dead
12,129	963	55	11

In May, as the tapping season was on the wane, the attention of the villagers was drawn to the results of this examination and to the likelihood of many of the palms that remained unexamined because

they were not ready or required for tapping being infected and, if left alone, spreading the infection to the trees they wished to tap next year. They agreed to examine those as well, and all were examined with the exception of 450 palms infested with scorpions, snakes, etc. Those the tappers would not climb. The complete results of both examinations were as follows:—

Number of palms examined	Found to be diseased but with no external symptoms	Found to be diseased and showing external symptoms	Found to be dead
20,831	1,265	72	13

These figures showed that six per cent. of the palms were infected without showing external symptoms, and that in this area the improved operations of cutting and burning dead and outwardly infected trees were dealing with only six per cent. of the total number of the diseased trees actually on the ground at the time.

In December 1914 when I visited Unagatla I had ninety-seven trees that had been examined in the previous March re-examined in the two worst infected fields and found eight diseased. The figures for the examination in March in the two fields were as follows:—

Number of palms examined	Number inwardly infected	Number outwardly infected	Number dead
(1) 375	240	6	1
(2) 1,387	218	8	1
1,762	458	14	2

The result of my examination of those eight trees led to the conclusion that (a) two had been unavoidably missed as the disease began from the fifth and the ninth leaf-base respectively, counting from the lowest on the tree, and eleven and thirty-three leaf-bases

respectively were penetrated, (b) two were probably avoidably missed as the lowest leaf-base in one, and the third, though exposed, leaf-base in the other were spotted and thirty-three and fifteen leaf-bases respectively were penetrated, (c) two had not had all the diseased tissue removed seeing they had been recorded as inwardly and outwardly infected respectively, and (d) two were probably infected during or shortly after the examination as the lowest leaf-bases were spotted and eleven and twelve leaf-bases respectively were penetrated. Two of them were outwardly infected in December and the other six had no outward symptoms. They would all have been discovered at a re-examination. Considering that this was the first time the examination had been done on a large scale, the work, though by no means perfect, was satisfactory from the point of view of materially reducing the disease. It was now definitely beyond the experimental stage, and we were in a position to assure the tree-owners that this method was a good one for detecting diseased palms at an early stage and dealing with them in a way whereby they were preserved instead of waiting till they were dead and useless before cutting them.

The intention in the general examination of palms that was now to be attempted was to take about seventeen leaf-bases off every palmyra within fifty yards of a dead or outwardly infected one and deal with the diseased ones found. To introduce this general examination of trees over the whole infected area that was being worked over was the biggest problem the members of the staff had to face since 1909 when the current system of operations was introduced. It was an uphill task demanding constant exposure in the fields during the hottest and driest part of the year and taxed their energies very considerably, but they did it successfully and it was an excellent piece of work.

It must not be thought that during this examination we made sure that every infected palm in the area covered had been dealt with. There would always be some cases that were actually missed, or in which the work was done imperfectly, or which though standing beyond the fifty yards limit were yet inwardly infected. It must also be admitted that this examination exposed the susceptible

parts of a great many trees to the risk of infection. The risk of passing on infection by means of the tapper's knife was avoided by having the knife sterilized in boiling water or by passing it through a flame, after the tapper had operated on a diseased tree and before he climbed the next one. But the risk of infection by beetles and by splashing during rain had to be taken. That was a weakness of the method but, if we had tried to protect the exposed surfaces with Bordeaux mixture or any other fungicide, the time taken to do so effectively with the staff at our disposal would have prevented the examination of the large number of trees contemplated. We hoped that because of the known slow rate of spread of the disease and because the work was done mostly in the dry weather, the rate at which trees would become infected would be much less than the rate at which they were being dealt with. As it turned out, taking the risk was justified by the result. Altogether 2,800,000 apparently healthy palms were examined between 1914 and 1919, and 99,938 that were found to have the disease were suitably dealt with.

The ordinary operations going on steadily month by month and the special spurt made to examine large numbers of palms in the dry weather each year had a gradually accumulating effect on the disease, and the number of deaths as well as the total number of diseased trees found each year fell rapidly. The results were severely tested by a series of unusually wet years, and the year 1918 was a critical year wherein the numbers of diseased palms in all the categories rose considerably, but a special effort was made from the latter half of 1918 to deal with every case of disease possible, with the result that the numbers again continued in a definite downward progression of substantial amount till 1921, the last year under review.

The people had sufficient faith in the operations to pay all costs except that of the special staff which was borne by Government. If they had become interested to such an extent as to act for themselves, then the special staff could have been withdrawn gradually and the people left to protect themselves against loss from the disease. Most people in the infected area knew about the disease and its symptoms but depended entirely on the special staff and the

village officers to deal with it. The next step was to develop a personal interest. By the application of the Pest Act of 1919 dealing with diseased palmyras became a duty, and it seemed not unreasonable to believe that after people got accustomed to tackling the disease themselves they would come to realize that they could fight it without extraneous help. To ensure that every person in the infected area and around it did know sufficient about the methods of dealing with diseased trees, his duties under the Act and the penalties for non-compliance, the special staff stopped the operations and devoted themselves to a publicity campaign. The fact of the operations being entirely stopped for four months seemed to have impressed the people that Government was in earnest. Pamphlets in the vernacular were written with illustrations given in colour and distributed to all the literate people directly and indirectly connected with the villages, and small posters with an illustration of a diseased palmyra palm were posted in thousands on conspicuous places. To reach the great bulk of the tree-owners who are illiterate, meetings were held in the villages where "sandwichmen" were sent round by day and lantern demonstrations were given by night. Verses were written and folksongs adapted, and they were sung at festivals and fairs, and mask dances were also a feature. Everything possible was done to excite interest, and there is no doubt of the success of the campaign the credit for which is in great measure due to M. R. Ry. Rao Saheb V. Bhogappaya Sastry Garu, the Special Deputy Collector. During the two years the Act has been in force there has been only one prosecution, a fact which speaks well for the tact of the special staff and more especially gives hope that the main aim of the Act will be realized.

SUMMARY.

(a) *The numbers.* During the fifteen years of the operations 1,188,077 palmyra palms infected with bud-rot were dealt with. The crowns of 956,446 dead ones were destroyed, and the diseased tissue was cut from 231,631 about ninety-four per cent. of which recovered and produced good healthy crowns. The number of palms

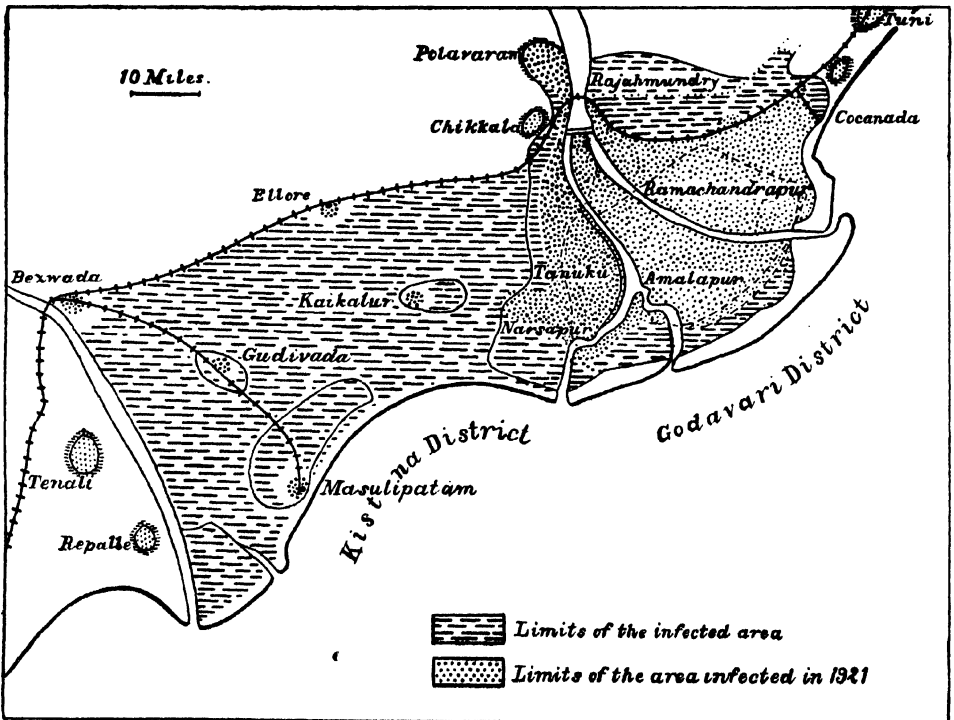
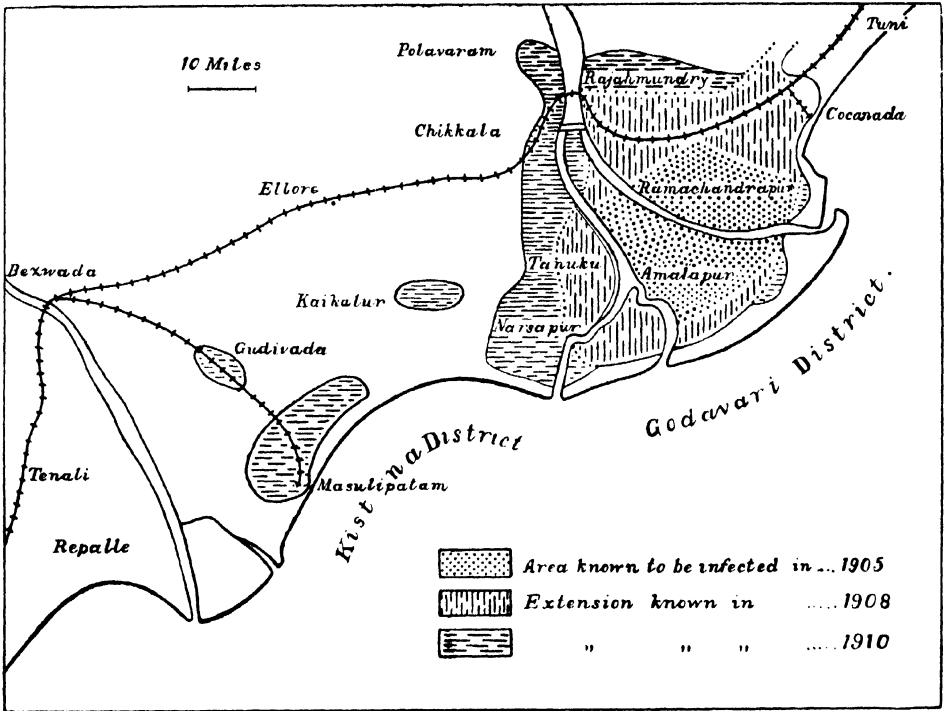

AREA INFECTED BY BUD-ROT IN GODAVARI AND KISTNA DISTRICTS.

that died annually was reduced from about 100,000 in 1908 to 8,700 in 1921.

(b) *The area* said to have been infected in the earlier years is shown in Plate XVIII. In 1905 it was about 500 square miles, in 1908 about 1,200, and in 1910 about 2,000 though subsequently acquired information showed that it had extended more towards the west in Kistna District than was known then. The ultimate limits of the infected region enclosed an area of about 4,000 square miles. Within this area, however, were considerable tracts where palmyras were few and the disease was light, and this is specially true of that part of Kistna District between the Godavari and Kistna rivers. In 1921 the disease was confined in Godavari District to the delta except for two villages near Rajahmundry, two near Peddapur and eight near Tuni which were discovered only recently, the disease having progressed there past the patrolled area. Beyond the river Godavari it existed in the villages on the right bank from Pollavarum to Narsapur and as far west as the Narsapur main canal. Beyond that it existed in isolated spots near Kaikalur, Gudivada, Masulipatam, Bezwada and Ellore and across the river Kistna in two villages near Repalle and six near Tenali discovered recently.

(c) *The intensity of the disease.* The Kistna area was never so intensely infected as the Godavari one, with the exception of those parts of Tanuku and Narasapur taluks between the Narasapur canal and the Vasishta branch of the river, and has been more amenable to treatment by the operations. The disease is in several isolated areas and is nowhere severe except perhaps comparatively so in the riverside villages. Though not to the same extent as in Kistna, the disease has disappeared throughout Godavari District from many places where it once existed, and there are still five areas in which it is severe though nothing like to the same extent as formerly, viz., around Rajahmundry, Mundapeta, Karapa, Vemavaram and Kotapeta. In general the disease has been pushed out and kept out of the uplands around the deltas except to a short distance on the banks of the Godavari river and in two other small areas, while in the deltas it has been thinned out and reduced in intensity.

(d) *The cost.* The total expenditure in connection with the operations from 1906 to 1921 has been in round figures three lakhs of rupees.

So far as they have gone, the operations can without hesitation be said to have reached on the whole a considerable measure of success, but much still depends on unwearied effort during the next few years to fix the benefit that has accrued in the reduction of the disease. Seeing that the people are illiterate and the modern idea of the cause of a disease and its prevention is quite novel to them, it is indeed wonderful that they have been induced to do so much and allow so much to be done. It reveals in an unlooked for way the firm belief of the people that the members of the departments of Government have their welfare at heart, and though their ways be past understanding the results are sure and the benefit substantial.

THE INFLUENCE OF NOTCHING ON THE YIELD OF THE FIG TREES.

BY

G. S. CHEEMA, M. Sc.,
Horticulturist to Government, Bombay ;

AND

S. R. GANDHI, B. Ag.,
Bombay Agricultural Department.

OF all factors that limit the cultivation of the fig in the Presidency of Bombay, the poor keeping quality of the fruit and the low yield of the crop are the most important. Low yield is due to careless cultivation. The plants are allowed to grow into bushes which are never pruned. Consequently new growth is scanty, and yield proportionately low.

The influence of pruning on the rate of new growth is undoubtedly great, but the degree to which the tree could be forced to bear a crop is unsatisfactory. It is observed when a branch of the fig tree is cut off squarely, a few buds, often one, below the cut develop into branches leaving the greater part of the stem naked. Such shoots during the growing period develop into long canes bearing fruit all along their length with very few side branches. As time advances, these canes assume the shape of long naked scraggy branches, the brushlike end portions of which would only bear fruits in season.

The inefficiency of these pruning operations in commanding satisfactory fruit bud formation suggested notching trials to test the influence of this process on the growth of dormant buds.

PREVIOUS INVESTIGATIONS ON THE EFFECT OF NOTCHING.

Sorauer¹ has observed that a notch above the bud diminishes the upward current of water, and the bud gets more water,

¹ Sorauer. *A Popular Treatise on the Physiology of Plants*, London, 1895, p. 158

and grows rapidly, while a notch below the bud helps in the accumulation of the plastic material, normally passing downward in the parenchymatous cells, in the neighbourhood of the bud which, thus supplied, remains bunchy and is very prone to change into a fruit bud. Passy¹ has described how a notch below a branch may weaken growth, while one above strengthens it. Vercier² has supported this statement, but both authors have brought forward no evidence for their conclusions.

Barker and Lees³, however, express the most modern view of this subject. They believe that food substances are not altogether responsible for the dormant condition of the buds, but that an inhibitory substance flowing downward through the stem brings most of the lateral buds on the basal part of a branch to a standstill, only allowing a few of the apical buds to continue growth. This assumption, therefore, suggests that notching above the bud may lead to increased shoot production. The study of this subject is, however, still in its infancy. Previous authors have given out their conclusions as suppositions more than on the basis of experimental evidence. The use of notching as a practical measure to increase yield of any fruit crop has hardly been applied hitherto.

Our results with figs, however, make one point clear. Sorauer has stated that a notch below the bud helps in the accumulation of plastic material which makes the bud bunchy and changes it into a fruit bud. Our results seem to contradict this statement. Notches made below the bud of a fig tree have not given any results whatsoever, while notches made above the buds have proved themselves very satisfactory.

METHOD OF NOTCHING.

The method of notching buds of a fig tree is a very simple operation. With a sharp knife a cut as deep as the wood is made just a little above the bud. Care must be taken to avoid the flow of the milky juice over the bud. Such juice may coagulate thickly

¹ Passy and Vercier. *Ann. Rept. Agri. and Horti. Stn., Long Ashton, Bristol, 1919*, p. 93.

² *Ibid.*

³ Barker, B. T. P., and Lees, A. H. Factors governing fruit bud formation. *Ann. Rept. Agri. and Horti. Res. Stn., Long Ashton, Bristol, 1919*.

over the bud and retard its growth. In practice it is observed that cuts in such cases should always be slanting. The notch must be



Effect of notching above and below a bud. Notching below the bud has prevented growth and kept the bud dormant. The bud with a notch above has grown into a vigorous shoot. (Date of notching, 10th November, 1922.)

deep and wide in proportion to the size of the branch. The breadth of the notch may vary from one-sixteenth to a quarter of an inch.

In about four days the bud below the notch swells, and after eight days it sprouts. In two months' time the shoots sometimes grow as long as two feet. If the wound is shallow, it heals up very soon, and the bud does not grow. If the notched buds fail to grow it may be due to improper notching or to the unhealthy condition of the bud.

Seasonal notching observations show that the buds which were notched in July develop sufficiently large shoots to bear fruits in the fruiting period. The shoots produced by notching later on, although vigorous and continuously growing, do not grow so rapidly as those of July notching. The wounds heal up more rapidly in the case of July notching than of October notching. Notching on lateral branches at any time is quite as successful as on the main trunk. In fact, buds can be notched at any time of the year if the fruiting of the shoot is ignored.

At this stage it is worth while mentioning that the operation of notching gives much less irritation to the plant than other methods adopted to accelerate its productiveness, and takes one or more months, according to the season, to fill up the notch. After four months the branches which were given out as a result of notching become so thick that the scars of notches above them are nearly untraceable. We have never found any parasitic fungi or insect pest lodging over the notches.



CONCLUSIONS.

(1) Notching in the manner described makes dormant buds grow. (2) Notching helps to increase yield, as the addition of more lateral branches means more fruits. (3) Notching helps to build up the desired shape of the tree. The whole framework of the tree becomes compact and handsome. (4) After notching the long naked scraggy branches become clothed with a number of laterals and thus are less breakable by wind. (5) After notching the fruits are less exposed to birds, due to the compactness of the framework.

THE MOSAIC DISEASE OF SUGARCANE IN INDIA.

BY

JEHANGIR FARDUNJI DASTUR, M. Sc., D.I.C.,
Officiating Mycologist to Government, Central Provinces.

ONE of the most serious diseases of sugarcane which causes severe losses in many cane-growing countries, such as Java, the Hawaiian Islands, Egypt, Porto Rico, Cuba, Louisiana and other Southern States of America, is the disease which is well known as mosaic, mottlings, yellow stripe, etc. It was first described from Java in 1890 and has since been introduced in other countries on cane imported from Java. In recent years it has attracted considerable attention, because it has spread very rapidly and because it causes enormous losses in tonnage. For example, in the Hawaiian Islands, the disease is responsible for the reduction in the yield of sugar from 5 to 40 per cent., depending on the variety of the cane; considerable decrease in yield is also reported from Porto Rico and in the United States.

The primary symptom of this disease is a general pallor of the leaves which is very conspicuous. The leaf loses its uniformly green colour and develops lighter coloured streaks or spots which form distinct patterns, as the normally coloured and mottled areas are sharply delimited; though there is a great diversity of patterns, still "the arrangement is so constant in any particular kind of cane that the characteristic can be used as an aid in determining varieties." The deleterious effects of the disease have been found to be cumulative in the United States and other countries. The secondary symptoms are observed only on ratoons of diseased cane or in plants originating from diseased cuttings. The mottled leaves develop opaque white spots on the light green areas and the stalks

may become cankered and attenuated. There is also a tendency towards shortening of the joints and premature development of roots at the nodes of standing cane.

This disease was first observed at Pusa in 1921 on D99 and Sathi 131. Only a few setts of the former were grown by the writer, while Sathi 131 was grown on the Pusa Farm. When this cane was found to be infected, the whole crop was uprooted and burnt, and the growing of this variety has since been discontinued. Fortunately, cane in the other cane-growing parts of India has been reported to be entirely free from this disease.

A short account of mosaic in Pusa is given below.

In February 1921, some thick varieties of cane were grown at Pusa (Bihar), on a small scale, in connection with cane smut experiments. Of these varieties, one was D99. Only three setts of this variety survived the attacks of white ants. In the first week of July the plants from these three setts showed a peculiar mottling of the leaves. The ground colour was dark green which was relieved by yellowish white or pale yellow spots or streaks which as a rule remained separate, but sometimes they ran into each other and occasionally formed islands of pale yellow surrounded by green. The upper surface of the mid-rib remained white and unspotted but the underside which is green in colour developed the mottling.

The same year in August, another variety, Sathi 131, of which about an acre was grown on the Pusa Farm, also showed discoloration of the leaves. There was a general pallor of the leaves, which could easily be spotted from a distance, in contrast with the healthy green colour of the other varieties of cane growing by the side of this variety. The leaves were covered generally by longitudinal narrow streaks, pallid green in colour and irregular in length (Plate XIX). At times the streaks were replaced by spots of varying size. The colour of the healthy leaf is dark green, but in advanced cases of the disease, the dark green remained scattered as small patches or "islands" surrounded by pale green or yellowish white colour. The upper surface of the mid-rib of a diseased leaf was not discoloured but its undersurface was mottled.



Fig. 1. Mosaic on leaves of Sathi 131, upper surface.

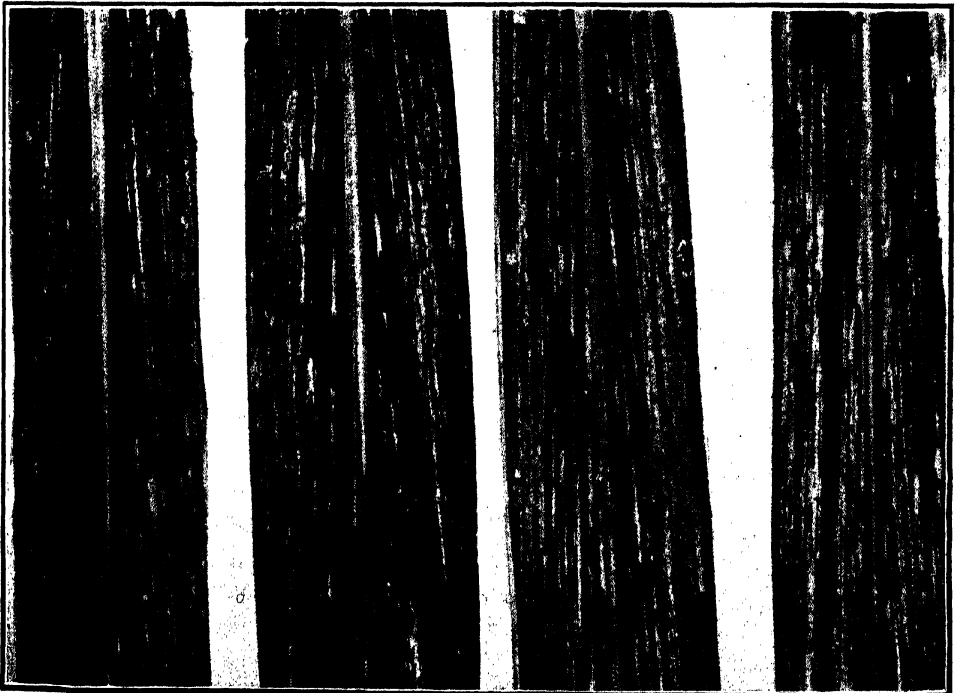

Fig. 2. Mosaic on leaves of Sathi 131, lower surface.

The growth of the badly mottled canes was considerably retarded, there being hardly any development of the stem ; but they tillered freely.

The secondary symptoms of cankering of the cane stalk, and the development of longitudinal white stripes on the nodes, which are common in Trinidad, have not been observed in Pusa ; probably because there has never been a ratoon crop of Sathi 131, as cane is not allowed to ratoon on the Pusa Farm. An infected stool of Sathi 131 was carefully transplanted to a big deal-wood box in August 1921. A few setts were taken from this plant in February 1922 and the remaining portions of the plant were kept undisturbed in the box. The setts developed mottled shoots but the internodes were neither cankered nor striped. The original parent plant and its tillers had been kept under observation till last January, but the stalks, though they were drying up, did not show the secondary symptoms ; the internodes were considerably shortened (the whole plant being not more than 2 feet high), and many of them were sunken and attenuated. The new shoots had hardly developed any stem. The new leaves showed very little of the normal green colour.

In August 1921, a few plants of Sathi 131 were inoculated with juice of the mottled leaves of D99. The juice was extracted by crushing the leaves in a marble mortar. It was diluted with distilled water, and injected, by means of a hypodermic syringe, in the growing points and leaf buds. In October the new crown leaves and the leaves of the shoots were mottled. The inoculated plants, except for the discoloration of the leaves, remained normal. The control plants showed no mottling of the leaves.

In February of the following year, setts from the inoculated and control plants were used as " seed." In March, the shoots from the setts of the inoculated plants showed early signs of mottling, and in April, the mottling was very distinct. The setts from the control plants developed healthy normally green shoots.

Similar inoculations on Sathi 131 were made with the juice extracted from the mottled leaves of Sathi 131 and the results were identical.

Sugarcane insects, like *Pyrilla* spp. (both adults and nymphs) and *Phenia moesta*, which are generally found in Pusa, were fed for four days on mottled plants of D99 and Sathi 131 kept in wire cages, and were then transferred to healthy plants of Sathi 131 similarly enclosed in wire cages. These plants did not develop any mottling.

In August 1922, setts of Sathi 131, Hemja and Saretha were injected with the juice from mottled leaves of Sathi 131. They were kept in moist chambers for four days before they were planted in big pots. In January of this year, Hemja showed the characteristic mottling of the leaves but Saretha and Sathi 131 had normally coloured leaves. Plants of Sathi 131, Saretha and *Saccharum spontaneum* also were injected through their "eyes" or leaf buds and through the cut ends of the stems, after removing the tops. Hemja developed mottling on the new leaves, but the others showed no signs of infection. It is not always that the injected plants show in one season visible signs of infection, which may remain dormant for a long time; for example, some Sathi 131 plants inoculated by injection in August 1921 did not produce any mottling of the leaves; but, the following season, plants raised from setts taken from these inoculated but apparently normal plants, and new shoots from these inoculated plants that were allowed to ratoon, in February 1922, developed typical mottled leaves.

The experiments described above show that the mottling of the leaves is due to some agency or cause which can be transmitted to other cane plants by injection.*

The variety D99 was first got from America along with some other canes for trial by the Pusa Farm. In 1920 this cane was discarded, as it was found to be unsatisfactory. It is probable that the unsatisfactory condition of the cane may have been due to this mosaic disease causing the mottling of the leaves.

Sathi 131 is a non-descript cane, which was originally received by the Pusa Farm in 1912, from a factory at Sathi in Bihar, hence

* While this paper was in the press, Ray Nelson of Michigan Agricultural College has found definite protozoan organisms in constant association with mosaic plants and therefore he considers that they are probably the cause of mosaic diseases.

the name, but its origin is not certain. This cane also proved to be unsatisfactory, because the percentage of sucrose was found to be low. Judging from the amount of mottled canes (over 800 stools in 0.77 acre) in 1921, and from the fact that for the 1921 season the setts were not imported but were taken from the farm crop of the previous season, it may well be assumed that this variety did not suffer for the first time that season from mosaic disease or mottling of the leaves ; but that it must have been infected, more or less, on the farm, in previous years as well. But because of the unconscious selection of cuttings or " seed " from well-developed plants with green leaves, the use of infected seed would be restricted, and because cane is not allowed to ratoon, not only the spread of the disease, year after year, would necessarily be slow, but the visible effects may also have been not so prominent and so general as to have attracted attention. The low sucrose content may have been due to the effect of this disease.

Whether the disease was first brought on the Pusa Farm in the original imported " seed " of D99 or of Sathi 131, and that the one caught the infection from the other or whether both were originally infected, it is impossible to say. However, the important point is that though this very serious disease of sugarcane, which has done considerable damage in several cane-growing countries, has been present on these varieties on the Pusa Farm, certainly for one year, and possibly for as many as eleven years, still the other varieties, which have been for years grown side by side with D99 and Sathi 131, have remained, so far, free from this disease ; the reason may be that either these varieties are inherently immune to this disease, or that, under local conditions, it is not capable of infecting them or that the carriers of this disease are not present at Pusa.

When in 1921, Sathi 131 was found to be badly infected by mosaic, all the other varieties were carefully examined and also the canes growing in the neighbourhood of Pusa, but they were found to be quite free from this disease. Since then a careful search has been made from time to time and to date no fresh attack has been observed.

POULTRY BREEDING IN THE UNITED PROVINCES.

BY

MRS. A. K. FAWKES,

Poultry Expert to Government, United Provinces.

THERE are three classes of poultry breeders in the United Provinces who may be said to be responsible for the carrying on of this industry and they may be roughly classified as follows.

Firstly, the European and domiciled community whose main object in keeping poultry is that of providing their household with eggs and birds, but who also sell eggs for hatching purposes and surplus birds for stock.

Secondly, the Indian gentlemen, chiefly Mahomedans, who keep poultry for pleasure and many of these are very keen fanciers.

Thirdly, by far the larger class of poultry keepers are what we may term the professional class, *i.e.*, those who make their living by the produce of their poultry, though a large number of people have other means of livelihood and add to their incomes by keeping a few fowls and selling what they produce. In the city of Lucknow, for instance, the market is largely supplied by house to house collections of small numbers of eggs in addition to eggs brought in by dealers from outlying villages.

The greater number of the professional poultry breeders come from the depressed classes to whom poultry keeping is a valuable asset, and one that, if encouraged, offers a great opportunity to a class of people too poor and uneducated to undertake other farming.

Among this latter class of people very valuable work is being done in Etah District by Mr. A. E. Slater, and a separate report is attached of what he is doing.

In the northern half of the province, especially in the districts of Saharanpur, Meerut, Moradabad and neighbouring parts, a very

large egg trade is carried on, which has as its central distributing station Saharanpur. To this depôt eggs, etc., are brought in by dealers in large numbers for the supply of the hill stations of Mussoorie and Simla. Large quantities of eggs from Peshawar also find their way to this market.

To foster this industry among all classes, Sir Harcourt Butler conceived the idea of instituting a Provincial Poultry Association and sent for myself as Poultry Expert, trained at Wye College and with considerable practical experience of both Home and Indian conditions of poultry farming, to carry out this work. The initial step was to construct a demonstration poultry farm at Lucknow as an educational centre. This farm was stocked with breeding pens of birds from Australia and Europe of proved heavy laying strains, and after 2 years of work the farm is now self-supporting. There is a ready sale for eggs and birds to the public, and a certain number of birds are given out at very low rates to deserving and suitable poor Indians. Students, both Europeans and Indians, are given courses of training at the central farm, and small branch farms have been started in about nine districts of the province. Educational work is also carried on by means of lantern lectures and holding of poultry shows for Indians at the many agricultural fairs held in the province. These are well attended and supported and have served to popularize the industry. The correspondence received by the Association is a proof of the ever increasing interest taken in this subject, and constant relays of visitors to the farm and the business done are a further proof that this work is meeting a need of the public for better stock kept under better conditions.

The Leghorn variety for village work has already proved itself an economic producer, and among the heavy breeds suitable for those in cities and with limited ground the Australian Black Orpington and the Rhode Island Red appear the breeds most capable of resisting climatic conditions.

Granted support by Government for a few years longer, this industry should make great strides and the poor producing fowls be gradually bred to better stock, deriving thereby great profit to the poorer classes of this province.

•

THE MISSION POULTRY FARM, ETAH.

(By A. E. Slater, B.S.A.)

THE Mission Poultry Farm at Etah was started by the American Presbyterian Mission in 1913 under the management of the writer, a lay missionary and graduate in agriculture, who has had charge of the work since that time, being authorized by the mission to give his whole time to it.

Object. The aim from the first has been to introduce, foster and encourage a "cottage industry" for the benefit mainly of the "depressed classes," it being the writer's desire and purpose to devote his life to their spiritual, social and economic uplift, and in his opinion no line of work offered a greater opportunity to those who have little or no land, capital, or education. Results have fully justified this hope.

Government aid. In 1915-16, the Local Government made a non-recurring grant of Rs. 3,500 and a recurring grant of Rs. 500. In 1920 the recurring grant was increased to Rs. 1,500, and in 1922 a non-recurring grant of Rs. 5,000 was made, and Rs. 5,000 entered in the estimates for 1923-24.

Experimental stage. The years from 1913 to 1918 were largely experimental. Many breeds were kept. Orpingtons, Wyandottes, Rhode Island Reds, Indian Game, Minorcas and Leghorns were all given a fair trial. Much valuable though costly results were obtained. Makes of incubators and brooders were tested out. Hearson's, Tammins, Cyphers, Buckeye and Cycle have all been tried, the premier machine for India seeming to be Hearson's.

The breeds kept have narrowed down to three—White Wyandottes, Black Minorcas, and Leghorns (both the Black Leghorn and White Leghorn).

The breed par excellence for the plains and village conditions. There is but little doubt that the Leghorn is the breed *par excellence*. Eggs are the main consideration, not a large table fowl, in India. The hens in the villages must live largely by foraging and also be small eaters. Another reason for Leghorns is that jackals and village dogs prey on poultry, and the Leghorn is a nimble bird well

able to fly and evade them. Also they roost at night largely on the trees nearby and are particularly hardy and stand the rains and exposure very well.

The Etah Poultry Farm. The farm consists now of about five acres. There are eight breeding pens with capacity of about 150 adult breeding stock, and six houses for accommodation of about 600 growing stock, also a house for sitting hens, hospital for isolation of sick birds, incubator room, *daftur* and grain godown. About 100 fruit trees have been set out for shade and a $4\frac{1}{4}$ b.h.p. oil engine and pump provides water. This year living quarters have been erected for training village boys and young men in poultry keeping.

Breeding operations are carried on for the supply of pure bred eggs at nominal rates of one anna per egg to villagers, and pure bred cockerels for distribution in selected villages for cross-breeding purposes. The general public are also supplied with eggs for hatching at Rs. 12 per dozen and breeding stock at an average rate of from Rs. 15 to 25 per fowl.

Village distribution. Every year has shown a growing demand for eggs for hatching. For instance, in 1921, 2,410 eggs were sold at one anna each. This year the number was 2,895 and these were purchased by 138 individuals. The demand far exceeds the supply, many being refused, and it must be remembered that there would be no difficulty in disposing of these at one rupee each to the public.

Great success has also followed the distribution of pure bred Leghorn cockerels for crossing purposes in selected villages. Last year one hundred were purchased by the U.P.P.A., and thus distributed. It is a comparatively easy matter to thus grade up a good, useful, hardy and productive fowl for village conditions, though I favour the establishment of pure bred Leghorn flocks in every case where a start is being made and country fowls not kept.

Sub-farms. Small breeding centres in selected villages have proved very successful. One man raised his own stock from eggs supplied, kept a breeding pen of ten hens and two cocks and distributed pure bred eggs in ten adjacent villages, selling these

at one anna each. His sales amounted to about Rs. 141 in the year for fowls and eggs; he had his original stock on hand and some young stock, and had created a keen interest in that vicinity for pure bred fowls of a good laying strain.

These centres should be greatly increased, and each centre could cater to from ten to twenty adjacent villages. They are one of the most promising features of all of the work.

The Etah Poultry Show. A popular and growing poultry show for Indians only is held yearly. This show is of value in determining whether we are going forward or back. Every one of the 438 birds exhibited this year were owned by Indians, of which 206 pure bred Leghorns and Minorcas were reared by the people of some thirty-eight villages in the Etah District. The judging was done by Mrs. A. K. Fawkes, Secretary of the U. P. Poultry Association.

The smallest unimproved country fowl weighed 1 lb. 13 oz., the best cross-bred hen weighed 7 lb. The weight of the smallest six country hens' eggs was 5 oz., the heaviest six cross-bred eggs weighing 14 oz. This proves what can be done by stocking the villages with good class poultry.

Cash prizes amounting to Rs. 450 were distributed: Hindus, Mahomedans, and Christians from the depressed classes were the winners.

The Etah Poultry Industry Exhibit. A decorative pyramid consisting of twenty-seven White Leghorns was erected in the Alfred Park, Agra, at the request of the Local Government, on the occasion of the visit of H. R. H. the Prince of Wales. Much interest and enthusiasm was awakened, and the car containing H. R. H. the Prince and H. E. the Governor slowed down to examine it.

There is no doubt that the country is waking up to the possibilities of poultry keeping as a sound profitable "cottage industry" for the poorest, and a paying hobby for the wealthy. Given business judgment, sound utility stock, and perseverance, success can be made of it, and a distinct addition to the economic wealth of the country, and to me its greatest value of all lies in its adaptation to the needs and requirements of the poorest and lowliest of village communities.

THE RELATIONSHIP OF THE SPECIES OF
FUSARIUM CAUSING WILT AND DRY
ROT OF POTATOES IN WESTERN
INDIA.

BY

S. L. AJREKAR, B.A.,

Plant Pathologist to Government, Bombay ;

AND

M. N. KAMAT, B.AG.,

Assistant Mycologist, Department of Agriculture, Bombay.

DURING the course of the investigations on potato cultivation in Western India, the results of which have been embodied in "Bulletin No. 102 (1920) of the Bombay Department of Agriculture," two distinct diseases of the potato plant came to be recognized, each due to a species of *Fusarium*, a wilt disease of the potato plant and a dry rot of the potato tuber. Nagpurkar and Kulkarni, the authors of chapter VII of the Bulletin which deals with this part of the subject, after mentioning one or two observations which incline them to suspect that the two forms of *Fusarium* found by them might perhaps be identical, remark that "the whole question of the relationship of the two forms requires careful and thorough investigation at an early date."

In 1920, during the course of several inoculation experiments with the two *Fusarium* forms on potato tubers, one of us (M. N. K.) had observed that while the tubers inoculated with the dry rot *Fusarium* normally developed the typical powdery dry rot, those inoculated with the *Fusarium* obtained from tubers showing the brown vascular ring characteristic of the produce from plants affected with *Fusarium* wilt invariably caused a soft rot.

Some evidence was also obtained showing that the temperature relations of the two forms were different. Thus the optimum for the wilt *Fusarium* was found to be between 23°C. and 25°C., while that for the dry rot *Fusarium* between 25°C. and 30°C.

It did not become possible, owing to some reasons, to pursue the subject further until June 1922. Cultures were then obtained from the underground part of the stem of a wilted potato plant and from a tuber showing the typical dry rot in storage respectively, and the morphology and physiology of the two forms were carefully studied.

The cultures were grown on glucose peptone agar * at temperatures between 23°C. and 36°C. A large number of observations were made of which the following may serve as samples :—

EXPERIMENT NO. 1.

(25°C. to 27°C.).

DRY ROT <i>FUSARIUM</i>				WILT <i>FUSARIUM</i>			
Date	Mode and extent of growth	Colour	Texture	Date	Mode and extent of growth	Colour	Texture
27-VI-22	Starting day	27-VI-22	Starting day
29-VI-22	Visible growth	White	Wooly	29-VI-22	No growth
30-VI-22	Good progress	30-VI-22	Growth just visible	White	Powdery
1-VII-22	Rapid progress	1-VII-22	Slow progress	Pinkish	..
2-VII-22	Tube full	Slight yellow tinge	..	2-VII-22	Meagre progress
3-VII-22	Tube quite full	3-VII-22

REMARKS. Wilt *Fusarium* makes slow growth at 25°C. to 27°C. Colour characters, as also texture, are different in the two forms.

* Prepared according to the following formula :—Glucose 10 gm., meat extract 2 gm., peptone 5 gm., sodium chloride 2.5 gm., agar 7.5 gm., water 500 c.c.

EXPERIMENT No. 2.

(At 36°C. constant.)

DRY ROT *FUSARIUM*

WILT *FUSARIUM*

Date	Extent of growth	Colour	Texture	Date	Extent of growth	Colour	Texture
7-VII-22	Starting day	7-VII-22	Starting day
9-VII-22	Slight visible growth	White	Wooly	9-VII-22	No growth
10-VII-22	Slight progress	10-VII-22
11-VII-22	11-VII-22
12-VII-22	No progress	12-VII-22
13-VII-22	Restricted growth	13-VII-22	Cultures transferred to 24°C.
14-VII-22	No progress	14-VII-22	Just visible growth
15-VII-22	15-VII-22	Very slow growth

REMARKS. While the dry rot *Fusarium* made very slow growth at 36°C., the wilt *Fusarium* remained absolutely dormant and showed no growth; but growth occurred when the culture was transferred to the normal laboratory temperature.

The following descriptions of the two *Fusaria* are based on many similar observations.

WILT *FUSARIUM*.

Growth aerial, texture powdery, colour pinkish at 23°C. to 25°C. and white at higher temperatures. Optimum temperatures for growth between 23°C. and 25°C. No growth at 36°C.

Mycelium, thin, with few septa.

Microconidia predominate in numbers. Macroconidia generally 2- to 3-septate, rarely 4-septate, narrow and short, hyaline, thin-walled.

Average size of macroconidia, 25-35μ × 4.2μ.

Average size of microconidia, $8-18\mu \times 3.7-4\mu$.

Microconidia pointed at one end.

Chlamyospore-formation very vigorous, terminal, intercalary or in long chains, 1 to 2 celled, thin-walled.

Conidiophores branched and in clusters. On potato agar and on sterilized potato slabs, blue coloured sclerotium-like bodies are formed in old cultures.

DRY ROT *FUSARIUM*.

Growth submerged, texture wooly, colour varying from white in young cultures to faint yellow in older cultures. Optimum temperature for growth between 25°C . and 30°C .

Mycelium, thick and with many septa.

Macroconidia are the predominant spore-form ; generally 3- to 4-septate, frequently 5-septate, rarely 6-septate, longer and broader than those in wilt *Fusarium*, thick-walled with big vacuoles in each cell, greyish in colour.

Average size of macroconidia, $20-40\mu \times 5.5-6.25\mu$.

Average size of microconidia, $10-20\mu \times 5.5\mu$.

Microconidia broad at both ends.

Chlamyospores bigger and formed later and in smaller numbers than in wilt *Fusarium*, spiny and thick-walled.

Conidiophores simple, unbranched. (Plate XX, figs. 3 and 4.)

INOCULATIONS ON TUBERS.

In order to ascertain any difference in the nature of the rot caused by these two obviously distinct forms of *Fusarium*, the following inoculation experiment was made.

Perfectly sound-looking tubers were washed with tap-water and subsequently dipped in 0.1 per cent. mercuric perchloride solution for two hours and then dried. These were divided into four lots, two of which were inoculated, each with one form of *Fusarium*, and the other two were left as controls. The fungus was introduced into the tuber by removing a small wedge of tissue, which was replaced immediately and sealed with paraffin to prevent infection by other organisms. The tubers were placed under glass covers.

The experiment was started on 28th June and concluded on 14th July, 1922. The following table summarizes the results :—

Inoculated with	No. of tubers inoculated	No. of tubers with successful inoculation	Nature and extent of rot	REMARKS
Dry rot <i>Fusarium</i> ..	6	3	Dry and slight	Vigorous sprouting of eyes of tubers.
Wilt <i>Fusarium</i> ..	6	6	Soft and extensive	Eyes of tubers killed.
CONTROLS ..	6	nil	nil
	6	nil	nil

REMARKS. The temperature throughout this experiment ranged between 23°C. and 24.5°C. The dry rot *Fusarium* caused the typical symptoms of the storage dry rot and the wilt *Fusarium* caused a soft rot, the flesh having turned pinkish. The former stimulates sprouting of potato eyes and the latter appears to kill them. (Plate XX, figs. 1 and 2.)

This result is an experimental confirmation of the belief of potato cultivators that the dry rot tubers germinate specially vigorously.¹

The inoculated fungus and no other organism was recovered from the rotten tubers in each case.

These results confirmed those obtained in experiments conducted by one of us (M. N. K.) in 1920 and placed beyond doubt the conclusion already arrived at on morphological and physiological grounds that the wilt *Fusarium* and dry rot *Fusarium* are distinct species. Plate XX, figs. 3 and 4, shows the characteristics of the two *Fusaria* in these experiments.

It is not possible to completely identify the two *Fusaria* dealt with in this paper without detailed comparisons with the host of species of *Fusarium* described in American literature, but we might mention that the dry rot *Fusarium* seems to us to agree more nearly with *Fusarium cœruleum* Lib., and the wilt *Fusarium* with *Fusarium radicolica* Wr., as described and figured by C. W. Carpenter² and

¹ Mann and Nagpurkar. *Bombay Department of Agriculture Bull.* 102, p. 63.

² Carpenter, C. W. Some potato tuber rots caused by species of *Fusarium*. *Jour. Agri. Res.*, Vol. V, No. 3, p. 183.

Sherbakoff,¹ than with *F. trichothecioides* Wr. and *F. oxysporum* Schlecht., respectively, as believed by Nagpurkar and Kulkarni.²

SUMMARY.

The *Fusaria* causing the dry rot of potato tubers and the wilt disease of the potato plant in Western India respectively are shown to be two distinct species both in their morphology and physiology.

They differ in spore measurements, form of growth, temperature relations and in the nature of the rot produced by each on the potato tuber.

¹ Sherbakoff. *Fusaria* of potatoes. *Cornell Agri. Mem.*, Nos. 3-8, p. 97.

² Nagpurkar and Kulkarni. *Ib.*, p. 62.

EXPLANATION OF PLATE XX.

Fusarium disease of potato.

Fig. 1. A. Tubers inoculated with Wilt *Fusarium*.

B. " " " " Dry Rot *Fusarium*.

" 2. Sectional views of tubers in Fig. 1.

Figs. 3 and 4. Wilt and Dry Rot *Fusarium*

(a) Macroconidia, (b) Chlamydo-spores, (c) Conidiophores with microconidia.



Fig. 1.

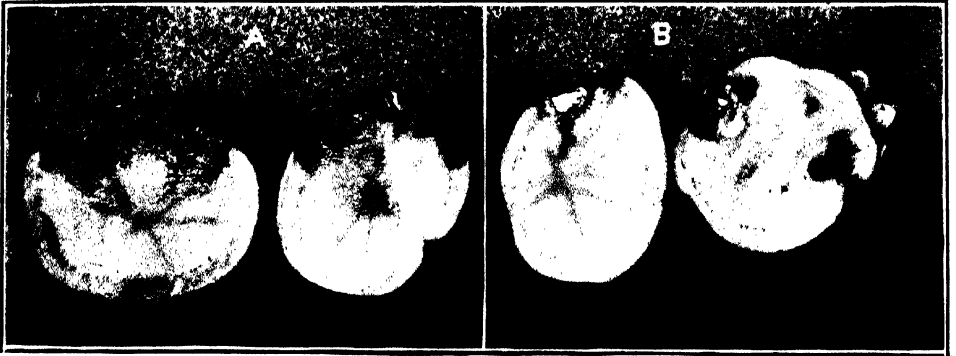

Fig. 2.

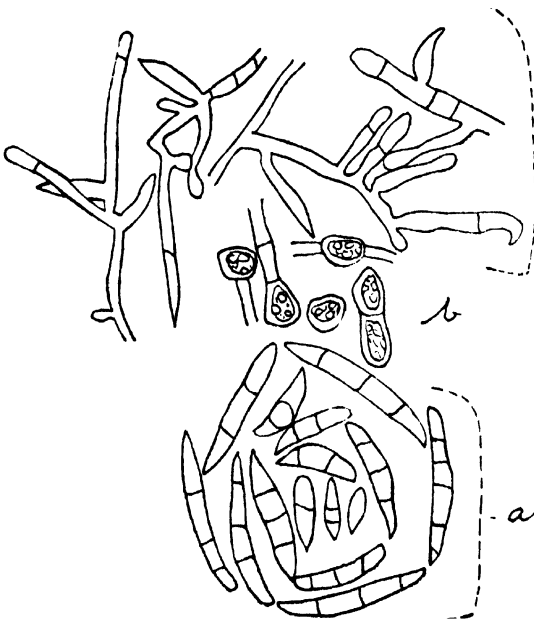

Fig. 3.

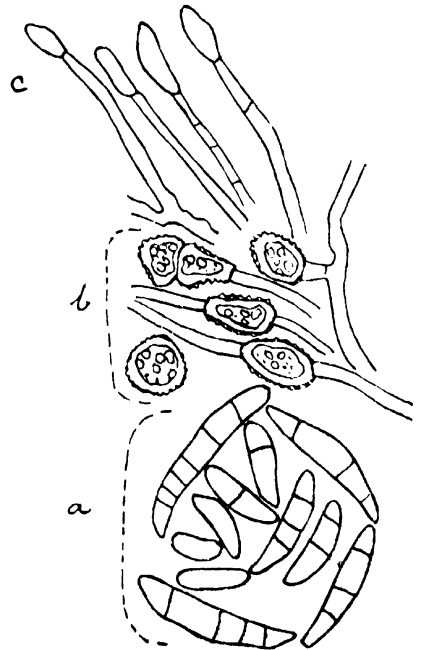

Fig. 4.

FUSARIUM DISEASE OF POTATO.

Selected Articles

HAWAIIAN SUGAR FACTORY RESULTS FOR THE 1922 SEASON.*

BY

E. T. WESTLY.

CONSIDERING, first, the varieties of cane milled, we find that the old stand-bys—Lahaina and Yellow Caledonia—are giving ground to H. 109 and D. 1135. Yellow Caledonia still leads, however, for 40·3 per cent. of the total 1922 Hawaiian crop was made up of this cane. H. 109 is now in second place—21·1 per cent. of the crop coming from this variety. 12·2 per cent. of the crop was D. 1135. Lahaina, once the leading cane variety in Hawaii, is now fourth in importance, as only 12 per cent. of the last crop was from Lahaina cane. We note, therefore, that in Hawaii they are not satisfied with their old canes, but are always looking for something better. Had they not done so, the Hawaiian crop would to-day have been very much less than it is.

As to the quality of the cane ground during 1922, the figures show that the cane was poorer than in any previous year. 12·97 polarization was the average with 14·91 maximum and 10·92 minimum average for any one factory. The average per cent. fibre was 12·95, which is the highest average recorded for any one year. One factory reported an average for the season of 15·68 per cent. fibre, while the lowest reported was 11·79 per cent. Average purity of first mill juice was 86·84 per cent., only a little higher than the 1921 average of 86·22 per cent., which was the lowest crop average on record. The best average first mill juice

* Reprinted from *Sugar News*, IV, No. 4, pp. 177-178.

purity reported by any factory is 88·9 per cent. and the poorest is 81·41 per cent.

Coming next to milling, we find that very high extractions are still being obtained by most of the factories in Hawaii. The average, however, was not as good as in 1921, and 1922 is the first year since 1911 that does not show an improvement over the preceding season. 96·98 per cent. extraction was the average for 1922 against 97·43 per cent. for 1921. The highest average obtained by any factory was 98·84 per cent. Five mills record averages over 98 per cent. and sixteen over 97 per cent. The lowest milling loss obtained was 1·10. The average milling loss was 3·02 against 2·64 for 1921. One of the main reasons for this drop in recovery at the mill is undoubtedly that less maceration was used. 34·75 per cent. dilution on normal juice is the average for 1922 and 39·30 per cent. for 1921. Less maceration and lower extraction has undoubtedly had its influence on the juice purities, as we find that the drop from first mill to last mill purity during 1922 was 17·71, against 20·33 in 1921, and the drop from first mill juice to mixed juice was 3·11 during 1922, against 3·45 during 1921. Tons cane ground per hour was, as in former years, very low.

A study of the boiling house work reveals several interesting facts. The figures show that more lime was used in clarification than previously, and in most cases a better increase in purity from mixed juice to syrup is reported. On the other hand, we find that more mud was obtained and the polarization of press cake was higher than in any previous year for which figures are available. It is the writer's experience that when juice is over-limed a greater volume of settlings are obtained and consequently the work required of the presses is increased. Several Hawaiian factories practising over-liming during 1922 report better recoveries. The density of the syrup was higher during 1922 than any previous year. The average density was 63·37 brix. No doubt this, to a great extent, is due to reduced maceration of the mills. The average polarization of the Hawaiian sugar crop in 1922 was 96·88, slightly higher than during 1921, when it was 96·75. The moisture content of the sugar is coming down from year to year and was, for 1922, 0·87.

Average gravity purity of the final molasses for 1922 was 38·75 against 38·53 for 1921. Notwithstanding the higher molasses purity, the loss of sucrose was less due to a lesser amount of molasses. This again was due to a higher purity syrup during 1922.

Undetermined losses are being lowered. The average was 1·27 per 100 sucrose in cane against 1·76 during 1921.

Commenting on the 1921 factory results in Hawaii, the writer made a comparison of the results obtained in 1914 and 1921, and would at this time like to correct a typographical error appearing on page 100 of the March (1922) Number of the *Sugar News*. The commercial sugar polarization per 100 polarization in cane figures for 1914 and 1921 should be reversed and should read 86·56 for 1914 and 85·86 for 1921, giving a decrease of 0·70.

The writer placed considerable stress on purities while commenting on the 1921 results, and will again discuss the subject.

Below is a comparison of some of the figures for the last two Hawaiian crops :

The polarization of cane is 0·15 lower for 1922. This should give less sugar in the bags.

The extraction was 0·45 lower in 1922 and should also tend to give less sugar recovered. The press work was poorer in 1922 (0·91 higher polarization than in 1921), indicating an expected further reduction of sugar recovered in the bag. When we also find that the gravity purity of the final molasses was 0·22 higher in 1922 than in 1921 we would be justified in expecting less sugar recovered, as everything points that way. But what is the fact ? The fact is that, in 1922, 87·02 per cent. of the polarization in cane was bagged as commercial sugar against 85·86 during 1921 or 1·16 per cent. more. Why ?

A higher percentage of the sugar coming to the Hawaiian factories in 1922 was put into the bags, even with poorer factory work, because in 1922 the purity of first mill juice was 0·62,—the mixed juice 0·96 and the syrup purity was 1·06 higher than in 1921. Watch the purities ! High extraction is good, so is low polarization of press cake and low gravity purity of final molasses, but in the writer's opinion it is of far greater importance to see to it that the

purity of the juice in the cane delivered to the mill is as high as possible and that this purity is improved in the factory. When all is said and done it is the amount of polarization put in the bags from the sugar coming in the cane to the factory that we are after. The higher purities the more we will recover. They automatically increase a factory's pan capacities, crystalizer and low grade centrifugal capacities. They also reduce the amount of labour required. High purities will also cut down on materials and will help to reduce costs per ton of sugar.

DECLINE IN THE AVERAGE YIELD OF EGYPTIAN COTTON.*

“THE basis of Egyptian agriculture and its relation to the decline in the average yield per feddan of cotton” is the subject dealt with by Messrs. E. McKenzie Taylor and A. Chamley Burns in Bulletin No. 25 issued by the Technical and Scientific Service of the Ministry of Agriculture, Egypt.

Many different factors have been given prominence as possible causes of the decline in the average yield per feddan of cotton in Egypt. Of these the most weight has hitherto been given to the effect of the increased height of the sub-soil water-table, the lack of drainage, deterioration due to salting, soil exhaustion, the incidence of fungal and insect attacks, and to deterioration in the plant. The effects of manuring, the reduction of supply of Nile silt and changes in variety of cotton grown have also been discussed. The present authors regard all these possible causes subsidiary at least to the preponderant effect of the conversion of Egypt from the older basin system of irrigation, practised prior to 1820, to the present system of perennial irrigation which has become general since that date. The basin system allowed of a period through May, June and July, during which the land received no water. The authors compare this enforced *sharaqi* period with the summer fallow, as practised on heavy lands in England, and to it they attribute the fertility of the soil in the older system of Egyptian agriculture. It is held that there has been no development in the agricultural practice of the country to meet the new conditions of perennial irrigation. The fertilizing properties of Nile silt are minimized, though the experimental evidence produced by the authors from the chemical and biological standpoints appear somewhat slight. Statistical evidence for the conclusion is also presented, and it is held that the fertilizing effects first observed by Russell in relation to the partial sterilization of soil

* Reprinted from *Jour. Textile Inst.*, XI^V, No. 1.

in England occurred as a result of the *sharaqi*. Thus it is concluded that the decline in the yield of cotton can be directly attributed to the factor limiting bacterial activity, and hence the formation of the optimum soil solution. It is suggested that since Egyptian agriculture in the future must be based on perennial irrigation, the *sharaqi* effect would be intensified by ploughing during the summer period, thus completely suppressing protozoa in the soil and restoring it to its crop producing power. The paper is illustrated by charts relating to the yield of cotton, and is furnished with an appendix describing a new method for determining ammonia in soils.

Whilst from the large volume of discussion and hypothesis in this paper based on relatively few experimental facts it may be difficult to accept the authors' conclusions, they should form a further starting point for a really scientific investigation into the decline in the yield of cotton in Egypt.

COTTON RESEARCH BOARD, EGYPT.

The Second Annual Report of the Cotton Research Board in Egypt claims to give substantial evidence that research has been seriously initiated into the varied problems connected with the cultivation of cotton. New laboratories have been staffed and equipped, and it is stated that the majority of the criticisms and suggestions received have been embodied in the present report. The botanists of the Board, however, differ from Dr. Balls and Dr. Harland in regard to the methods of comparison used in relation to field experiments. The critics recommended the use of flower and boll counts for purposes of comparison, instead of crop yields, but the local workers prefer the latter method, owing chiefly to the labour involved in collecting data by the former method, and also because the farmer prefers results in the form of crop yields. Investigations involving the recording of flower counts are also being carried out.

The report proper opens with a note on the decline in yield of Egyptian cotton, but evidence is produced which justifies the conclusion that with careful cultivation and due attention to seed selection the Egyptian crop could be very substantially improved in

quantity and quality. Of the commercial varieties grown in Lower Egypt, the tests of the past two years show that Sakel grown from Domains' seed is by far the most profitable variety to grow, with the possible exception of Dr. Balls' variety "No. 310." Some of the Botanical Section's selected strains are also highly promising. It is noteworthy that none of the proprietary varieties attain the standard of the seed in the possession of the Government. Drainage experiments have indicated that considerable differences in the level of the sub-soil water produced no effect on the crop. If this result be confirmed, it will modify present views as to the effect of the soil water-level in relation to decline in the yield of the crop. Experimental work on the extraction of pure lines, on bulk selection and propagation of selected strains, field tests of varieties, hybridization, growth and flowering curves, bud and boll shedding, sore-shin wilting and on boll-worm is described in considerable detail in the second part of the report. The third section deals with the programme of experimental work for 1922. This includes work on the partial sterilization of soil and the effect of Nile silt as a fertilizer on the chemical side, and from the botanical standpoint cotton breeding on similar lines to the work in the present season will be continued. Experiments will also be carried out on the water table in relation to root growth, the effect of irrigation on lint length and on sore-shin, and wilt diseases, as well as many other matters on which work has already been initiated. On the entomological side, boll-worm and other insect pests will be studied in detail. The report concludes with four parts devoted to summaries of literature relating to cotton in Egypt and in the rest of the world, and a number of appendices deal with the Egyptian climate, cotton legislation in 1921, Egyptian moneys, etc. The report is fully illustrated by charts, and must prove extremely valuable to all concerned with matters relating to the production of cotton.

Notes

POST-GRADUATE TRAINING IN AGRICULTURE AT PUSA.

THE following press communique, dated 22nd June, 1923, has been issued by the Government of India in the Department of Education, Health and Lands :—

In relation to the Provincial Agricultural Colleges the Agricultural Research Institute and College at Pusa occupies the position of a higher teaching institution in enabling students by means of post-graduate courses of the highest possible standard to qualify for the best appointments in the various branches of agricultural work not only in India but in the neighbouring Colonies. The position of the Pusa Institute and College was examined by the Royal Commission on the Public Services in India, and it was recommended that (1) Pusa should be maintained principally for research work, and (2) facilities should be provided at the Research Institute for the training of post-graduate selected students in agricultural research up to the highest standard provided by the best equipped agricultural institutions of Europe and America, such additions being made to the staff of that institution as might be necessary for the purpose. A scheme for the expansion of the Institute to provide training on a larger scale both for direct recruitment and promotion to the Imperial Service has been sanctioned by the Secretary of State, but the depressed condition of the Imperial finances makes the immediate realization of the full scheme impossible. Excellent facilities, however, exist at Pusa for a complete training in special branches of agricultural science, such as, Agricultural Chemistry, Botany, Mycology, Agricultural Bacteriology and Entomology. and since its establishment the Pusa Institute has given post-graduate training in these specialized branches to

131 students, besides affording laboratory facilities to 26 scientific research workers for short periods. Most of these students, who have undergone the post-graduate training, were deputed by Local Governments and Indian States, and many of them have been absorbed in their respective agricultural departments, a few in the Indian Agricultural Service cadre and the rest in the Provincial Services.

With a view to develop the post-graduate training at Pusa to the highest possible standard so that Indians who wish to enter the Indian Agricultural Service may be afforded facilities comparable with those available to European students, the prospectus of the Pusa Institute has been under revision. The revised draft was considered by a special conference held at Pusa in February 1922, and it was recommended that admission to those post-graduate courses in special subjects should be strictly limited to post-graduate students who may be :

- (1) Students who have passed with distinction through the course of a Provincial Agricultural College and are recommended by their Local Governments.
- (2) Graduates in science from an Indian University who should preferably, subsequent to taking their degree, have spent at least one year at an Agricultural College and who are recommended by the Director of Agriculture of the province as likely to profit by the course of instruction which they propose to follow.
- (3) Students deputed by an Indian State who may be admitted on the application of the State concerned, provided they have the qualifications indicated above, and that accommodation is available.

The conference was also of opinion that a two years' training under the specialists would form a suitable qualification for admission to the Indian Agricultural Service. It was, however, considered that what was wanted was more the association of the post-graduate students with the research work in progress rather than a hard and fast course of instruction, and that it must be left open to the Head

of the Section concerned to frame the course of instruction so as to suit individual requirements and afford all facilities for conduct of research.

The Government of India have accepted these recommendations with slight modifications and have decided to start these courses in the next cold weather commencing from 1st November, 1923, and to throw them open to distinguished graduates of Universities or Agricultural Colleges and also to students who have undergone training in agriculture and its allied branches in British Universities or in one of the recognized Agricultural Colleges and who possess suitable qualifications. Candidates for admission will appear before a responsible selection committee and only those who are likely to be able to make the most use of the courses will be selected. As a start it is proposed to admit twelve students to these post-graduate courses commencing on 1st November, 1923, viz., 3 in Agricultural Chemistry, 2 in Mycology, 2 in Entomology, 3 in Agricultural Bacteriology and 2 in Botany. For further particulars regarding the courses, fees chargeable, etc., application should be made to the Director and Principal, Agricultural Research Institute and College, Pusa. All applications for admission must reach that officer before 1st October next.

It must, however, be pointed out that the Government can give no guarantee of employment, and that the number of specialists appointments in the Indian Agricultural Service cadre, both under the Imperial and Provincial Governments, is very limited, the normal rate of recruitment to these research posts being less than one a year.

A further press communique, dated 28th June, 1923, states :—

The Government of India have had under consideration for some time the provision of courses of study qualifying for admission to the Indian Agricultural Service.

Officers entering this Service generally belong to two classes :—

- (1) The general (or agricultural) branch occupying such posts as Deputy Directors of Agriculture, Professors of Agriculture in the agricultural colleges, etc.

- (2) The specialized branches such as Chemistry, Botany, etc.

While excellent facilities exist at the Agricultural Research Institute, Pusa, for a complete training in Chemistry, Botany, Agricultural Bacteriology, Entomology and Mycology, training in the general branch, owing to the width of the subject, presents considerable difficulties. The qualifications accepted from candidates for the general branch recruited from abroad are :—

- (a) a degree or diploma of a recognized University or Agricultural College ;
- (b) experience of practical agriculture on an up-to-date farm.

India at present possesses five well equipped Agricultural Colleges in the provinces teaching up to a standard similar to recognized institutions abroad, but facilities for obtaining a correspondingly good post-graduate experience in practical agriculture have, owing to a variety of reasons, among which is the general backwardness of agriculture in the country, not hitherto been available.

At a conference held at Pusa in February 1922, it was decided that the only satisfactory alternative to sending young Indians abroad for this experience was the institution inside the country of courses in special branches of practical agriculture suited to graduates or diplomates of the Provincial Agricultural Colleges offering at least as good opportunities as exist elsewhere. Animal husbandry and agronomy, agricultural engineering, and plant industry were suggested as suitable branches of practical agriculture for post-graduate training, and it was recommended that a six months' course in each of two of these branches be considered equivalent to the usual practical experience gained abroad in counting for qualifications for the Indian Agricultural Service.

It is the intention of the Government of India to establish a complete course of the type recommended by the conference at Pusa when funds permit. For financial reasons they are unable to start a complete course in agricultural engineering at once ; but they hope at a very early date to be in a position to initiate a course in agronomy. They have decided to begin with a course in animal

husbandry and dairying, coupled with a special course in agriculture at Pusa, which will be confined to officers of the Provincial Agricultural Service who have put in at least 2 years' service in the local Agricultural Departments. Local Governments are being invited to recommend officers for this course. The transference of three of the military dairy farms to the Agricultural Department will provide the latter with nearly all the equipment necessary for a course in this subject and offers an opportunity of making an early start with the course. In view of the delay involved in the inauguration of the other proposed courses, the Government of India have decided to accept as a provisional measure a 15 months' course in animal husbandry as equivalent to two 6 months' courses in the other branches, and propose to open the first course next cold weather at the dairy farm at Bangalore under the Imperial Dairy Expert and the Physiological Chemist in charge of Animal Nutrition, finishing off at Pusa under the Imperial Agriculturist. Applications for particulars as to syllabus, fees, etc., should be made to the Director, Agricultural Research Institute, Pusa. It is not expected that the tuition fees will exceed Rs. 25 per pupil per mensem.

* * *

COTTON RESEARCH STUDENTSHIPS.

THE following notice issued by the Indian Central Cotton Committee with regard to the research studentships which they propose to offer will be of interest to many readers of the *Agricultural Journal of India*. To prevent misunderstanding it is perhaps desirable to emphasize the fact that these are research studentships and not research grants. The object of the studentships is to build up in India a corps of qualified investigators in cotton problems. It is not proposed to allow students to select their own subjects for research. After such preliminary training in research methods as may be necessary, the intention is that a specific piece of work connected with the general cotton research at the institution in which he is working should be allotted to each student to be carried out under direction.

NOTICE.

The Indian Central Cotton Committee will award this year six research studentships for the encouragement of cotton research. Applications are invited from distinguished graduates of Indian Universities which ordinarily should be submitted in the first instance to the Director * of Agriculture of the applicant's Province or State. Selected applicants must be prepared to attend at Bombay for interview at their own expense.

The research studentships are of the value of Rs. 150 per mensem and, subject to a satisfactory report on the first year's work, will be tenable for two years. Successful candidates will be required to devote their whole time to research work during their tenure of the studentships, will be placed under an experienced research worker actually engaged on cotton research for training in research methods and will be expected to carry out a definite investigation under general direction.

In allocating students to the various institutions in India offering facilities for such students consideration will be given to the student's wishes, but the Committee reserve absolute discretion in this respect.

The Committee desire it to be clearly understood that no guarantee whatever of subsequent employment is given or implied by the grant of a scholarship. The Committee believe, however, that there is a demand in India for qualified research workers and will keep possible employers advised of the names and qualifications of suitable candidates.

The Committee reserve the right to require each student to enter into a bond, on such terms as they may decide, agreeing to engage diligently in research work during the tenure of his studentship and, if called upon to do so, to refund to the Committee the amount of the studentship drawn by him in case of resignation before the expiry of its tenure or of its forfeiture for misconduct or for unsatisfactory progress.

* Applications from Sind should be addressed to the Deputy Director of Agriculture, Karachi.

Studentships for 1923-24 are provisionally allotted to the different branches of agricultural science as follows :—

Botany	..	Cotton-breeding	..	3
Entomology	..	Cotton pests	..	2 or 1
Mycology	..	Cotton diseases	..	1 or 2

Applications should state the candidate's age, present employment (if any), particulars of any research work already carried out and full details of University career with copies of testimonials and certificates which will not be returned.

* * *

HOW TO MAKE MANURING PROFITABLE IN INDIA ?

I HAVE read the article in the *Agricultural Journal of India*, Vol. XVIII, Part II, on "Experiments on the Green Manuring of Rice" by Messrs. Somers Taylor and Manmathanath Ghose, with a great deal of interest. Their results are all the more interesting if considered in conjunction with an article on "Commodity Prices and Farming Policy" by Mr. Orwin in the *Journal of the Royal Agricultural Society of England*, Vol. 83.

The conclusions in the case of wheat in England may be applied to these results for paddy. It is evident from Table III published in the *Agricultural Journal of India*, that each increase in cost of applying increased quantities of bonemeal in conjunction with green manure was accompanied by a smaller proportionate return, and that a point would be reached sooner or later (determined by the price of paddy) at which the increased return is insufficient to meet the increased cost.

If we chart the figures given for paddy as Mr. Orwin has charted those he quotes for wheat, we obtain the curves Nos. 1 to 3 in the accompanying graph. The cost of production rises uniformly with increasing applications of bonemeal, costing Rs. 8-6 per cwt. On the other hand, the profits which rise steeply for the first cwt. begin at once to flatten out after this point, and the third cwt. of bonemeal gives a very small return on the extra money expended and results in an actual loss.

This is much more apparent if we plot the successive *increments* in cost of production and the accompanying successive increments

of profit obtained. This has been done in curves Nos. 4 and 5 on the graph, and it will be seen that the curve of successive increments of profits falls below that of successive increments of cost after the first application of bonemeal, so that it is not worth while incurring

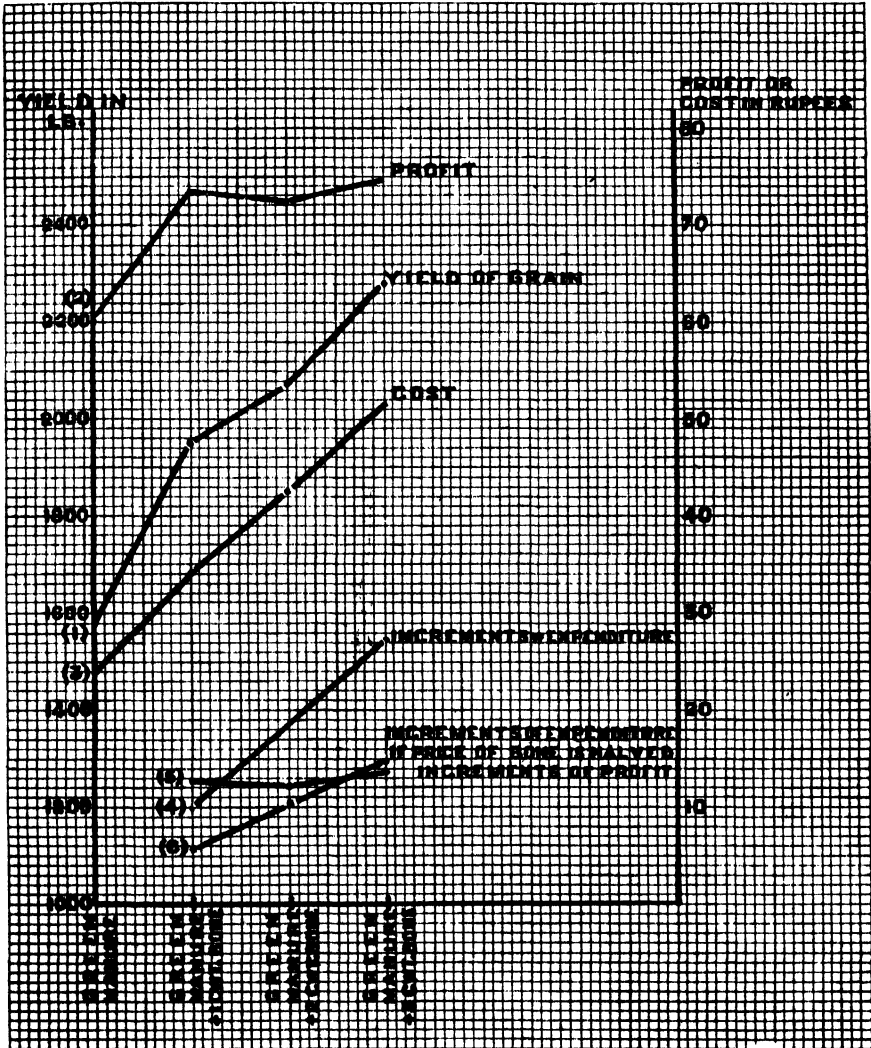

expenditure on further applications even though these increase the yield of grain by 31 and 44 per cent. respectively.

As Mr. Orwin points out, "Intensive cultivation and liberal expenditure on manure is only justified in times of high prices and is no remedy for low ones," and this was preached by Lawes

more than a generation ago and illustrated by experiments at Rothamsted.

There is, however, a factor at work in India, which affects this problem and which has not been taken into consideration by Mr. Orwin because it is not operative in England to the same extent. This factor is the steadily rising price of an indigenous manure like bonemeal owing to its demand in other countries and its constant export. This is a question which has been raised again and again by representatives from Madras at meetings of the Board of Agriculture for India and elsewhere. Here we have an excellent illustration of the effects of these high prices.

Suppose for the sake of argument and to make the point quite clear, by some means or other (possibly by the total prohibition of the export of bones as suggested by Madras) the price of bonemeal could be halved, in this particular case brought down from Rs. 8-6 per cwt. to Rs. 4-3, at once the position is changed.

Our increment of cost of production curve falls as shown at No. 6 on the graph and the second application becomes a profitable one. Even at this price the third application is unprofitable, which emphasizes the fact that every effort ought to be made to reduce the price of indigenous fertilizers like bonemeal in this country if manuring is to be profitable. If this is not done, in face of figures like these, it is useless for the Agricultural Departments to go on teaching the ryots to use manures. [RUDOLPH D. ANSTEAD.]

* * *

ROOT DISEASE OF SUGARCANE IN JAVA.

A MONOGRAPH* on the factors influencing the occurrence of root disease in sugarcane in Java with special reference to the seedling cane E. K. 28, the best variety now planted in Java, which is specially affected, has been issued by Dr. J. Kuyper.

No special fungus or bacterium has been found in Java as the cause of root disease, nor has the work published in other

* *Archief voor de Suikerindustrie in Nederlandsch-Indie*, 1923, 2de deel, pp. 117-161; and *Mededeelingen van het Proefstation voor de Java Suikerindustrie*, Jaargang 1923, No. 4 (with many tables and 2 graphs). ▴

countries proved anything definite on this point. The author has therefore confined himself to a careful investigation of those factors which were in the first place responsible for the appearance of this disease. It is proved that anaerobic conditions, especially when caused by bad drainage, excess of irrigation water or other means, are very favourable for the occurrence of the disease. In low flat lands with bad drainage where the level of the sub-soil water is very high, E. K. 28 can hardly be grown, while in deep good sandy soils with good drainage it is far and away the best cane.

The more plant residues remain in the soil the more dangerous are the anaerobic conditions, and for this reason the longer the fallow after the cane crop the better.

In Java they have two systems of crop rotation, cane in a two-year rotation and cane in a three-year rotation. The latter is best for dealing with root disease.

Varying water content in the soil and quick and numerous changes in it seem to aggravate the consequences of an attack of this disease.

The author also discusses the question of soil sickness and organic poisons in the soil. He does not think it necessary to bring forward these facts as an explanation of root disease.

The disease is not spread by the seed, but plant cane which is ripe and therefore easily attacked by putrefying organisms helps the disease by causing an anaerobic medium around the young roots.

The planters in Java were very much afraid that the disease was spreading, but tables and figures prove that there is no ground for this belief—E. K. 28 formed 2 per cent. of the planted area in 1916 and 40 per cent. in 1922. The area with root disease has increased during these years but not relatively to the increase of the area under E. K. 28.

Climatic conditions also have much influence—one year showing a small area, another a much larger one. In this connection, the predominant effect of climatic conditions on the different cane varieties grown in Java is dealt with.

Cane which was affected with root disease in a certain field in a certain rotation may remain perfectly free from it when subsequently planted in the same field. This depends on whether the disease was originally brought on by bad cultivation, which can be remedied, or by the field being unsuitable for cane in which case nothing can be done.

Notwithstanding its susceptibility to this disease, it is evident that E. K. 28 is out and out the best cane in Java, even on estates liable to root disease. The average crop throughout the area (40 per cent.) planted with E. K. 28 is much higher than the average crop under other varieties. The writer urges the planters to fight the disease by means of most careful drainage, cultivation and irrigation, so that they may be able to grow this cane, which will well repay them. He also points out that care in cultivation is one of the best means of protecting a crop against all pests and diseases.

* * *

IS FLOWERING A SERIOUS DRAWBACK IN A NEW SUGARCANE ?

THE rather free flowering of some of the Coimbatore seedling canes in certain of the North Indian farms, coupled doubtless with the very novelty of it, has caused anxious enquiries to be made as to any measures that could be adopted for checking it. The flowering has been assumed to be a serious drawback. The harm from flowering results, chiefly, from the stoppage of further growth in the main shoot and the sprouting of buds immediately below, resulting in a lower tonnage. Frequently also, the flowered canes develop a pith in the centre. If cut fairly early after the flowers appear, the phenomenon appears to be practically harmless to the crop. In Java, it is said, cane crops frequently flower and this is not considered a serious disadvantage. The following extract¹ is of some interest as showing that in the case of early canes—and early canes are much to be preferred over large tracts in North India—the flowering is even an advantage.

¹ *Int. Rev. of Sci. and Practice of Agri.*, July 1922, p. 836.

“ The Insular Station (at Porto Rico) has recently carried out a considerable amount of chemical investigation to determine the effect, on the sugar content of the juice, produced by the flowering and subsequent growth of the axillary buds. The results of the analyses of samples taken at different stages from a number of varieties show that on an average the flowering cane gives about 1 per cent. more sucrose and 2 per cent. higher purity than the non-flowering, and the percentage of reducing sugars is also appreciably less. These differences appear to be more marked early in the season. The conclusion is therefore drawn that flowering is not desirable in late varieties, nor in fields reserved for late cutting, but it is clearly of advantage for early canes.” [T. S. VENKATRAMAN.]

* * *

REPORT ON THE THIRD ALL-INDIA EGG-LAYING COMPETITION.

THE interest taken and the success achieved in previous competitions held at the Lucknow Model Poultry Farm by the U. P. Poultry Association has again this year (1922) been repeated, and the Indian laying test has become quite a popular event in poultry circles, both out here and overseas.

The advantage that must accrue to poultry stocks in this country by the annual influx of the best egg producing strains of fowls from overseas is obvious. All imported birds are sold to the highest bidder after the test, and most breeders send a good cockerel mated to their entries, so that purchasers are able to breed straight away from these tested layers. Some of the birds fetched as much as Rs. 150 per trio and no sum lower than Rs. 25 per bird was bid.

The number of birds entered was 93 but 16 of these were refused or withdrawn as unsuitable, strict supervision being exercised by the Association in order that only healthy matured pullets should compete. The remaining 77 birds were penned in single compartments, a daily record being put up on each pen of the eggs laid. Some 18 birds were sent from England and Ireland, arriving on the

25th October in the pink of condition, excellent shipping arrangements having been made by Spratts Patent, Limited.

These birds started to lay forthwith and, with one or two exceptions, kept up a steady production, only two birds going into a partial moult. This is satisfactory considering the distance the birds had travelled and the difference of climatic conditions.

Australorp pullet : Bred from U. P. P. A. Strain imported in 1920 from Australia.

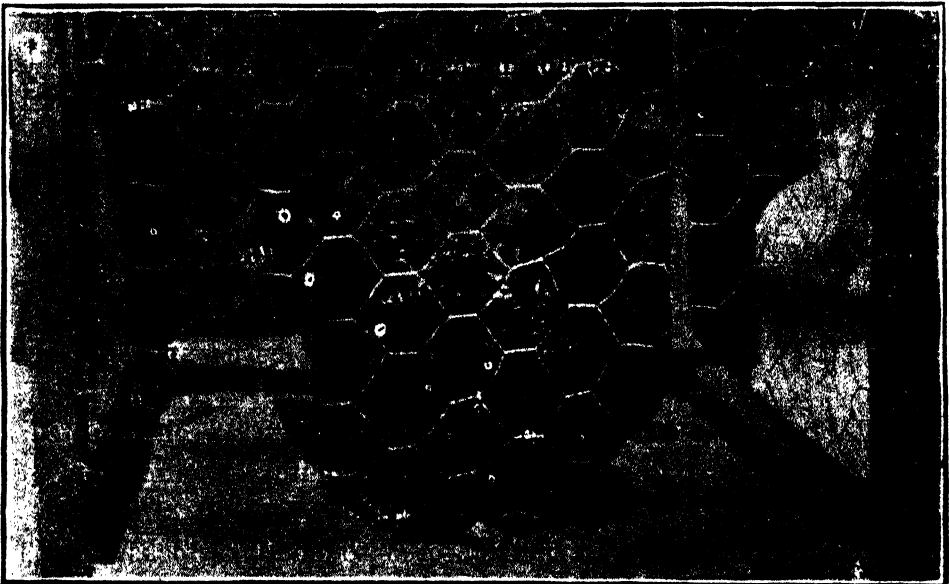

Winner of H. E. the Governor's Cup. (Laid 77 eggs in 92 days.)

The climate of Northern India, in spite of very great contrasts between night and day temperatures, is conducive to egg-laying, and the severe cold at night experienced during the heavy winter rains did not affect the egg records, though all birds were housed under practically open air conditions. The single pens used in the tests are merely wired in on all sides, the only protection given being that of canvas curtains which are let down at night. The day temperatures were high, the pens being situated in the open sunlight (the contrast was sometimes as much as 40° - 85° in the sun and 45° in the shade). Only two birds, both Indian bred, died within a day or two of their arrival. The remaining 75 birds

produced a total of 3,592 eggs during the 3 months' test, *i.e.*, from 1st November, 1922, to 31st January, 1923, an average of 47·9 per hen. This is a higher average than in previous years, last year's record being 3,320 eggs for 80 birds and that of 1920-21 test 2,049 eggs for 55 birds.

The eggs were sold to the public for table purposes, realizing an average of rupee one and annas twelve per dozen eggs.

METHOD OF FEEDING.

Morning (7 A.M.).—Grain (mixed) 2 oz. per bird buried deeply in the sandy litter of each bird's house. The following grains were used—wheat (*geon*), unhusked rice (*dhan*), *bajra* (*P. typhoideum*) and gram.

Midday.—Green food (lucerne), *palak* (Indian spinach), cabbage and salad leaves ; a large bunch to each bird.

Evening.—Mash, based on 2 oz. dry per bird, composed of :—

	1st month	2nd month	3rd month
Bran	.. 4 parts	3 parts	2½ parts
<i>Atta</i>	.. 2 „	2 „	1½ „
Gram flour or maize			
flour in rotation	2 „	2 „	2 „
Meat (cooked)	2 „	3 „	4 „

The meat was in the form of tripe and offal of goats ; the high proportion used has been found to do no harm to the birds as would be in the case were meat meal, *etc.*, used.

The remarkable feature of the test was the performance of a semi-country (*desi*) semi-Leghorn pullet, her dam being *desi* and sire a Brown Leghorn. This pullet laid 61 eggs in 66 days, and would have probably won the competition had she not got ill to begin with from the unaccustomed food. She came from a village near Bara Banki and had had no special care or treatment. The result encourages the hope that the ordinary *desi* fowl is very amenable to improvement by crossing with highly fecund cocks, and it is to be hoped that more of this cross breeding will be done in the future by Indian poultry breeders.

CUP WINNERS.

Handsome cups were donated to the leading birds. The following is the list of specials.

1. His Excellency the Governor's cup for the best layer, irrespective of weight of eggs, won by Mrs. Richardson's Australorp pullet, bred in India, with 77 eggs in 92 days.
2. Best layer from overseas. Lady Anderson's (England) Light Sussex pullet. Presented by the Stewards of Lucknow Races.
3. Best layer from India. Same as No. 1. Presented by the Stewards of Lucknow Races.
4. Best layer in the United Provinces, India. Mrs. Johnson's Lucknow White Leghorn pullet. Cup presented by the Rani of Kantit, Mirzapur.
5. Cup for the best team, won by Master Charters, Amballa. For White Leghorn pullets. Cup presented by Right Hon'ble Lord Dewar, London.
6. Cup for the best layer bred by or purchased from the U. P. Poultry Association. Same as No. 1. Presented by the U. P. P. A.
7. Best layer, light breed. Mr. Bradbury's (England) White Leghorn pullet. Cup presented by the Raja of Mursan.
8. Best layer, heavy breed. Lady Anderson's (England) Light Sussex pullet. Cup presented by the U. P. P. A.
9. Best layer, White Leghorn. Same as No. 7. Cup presented by Messrs. Perry & Co., Lucknow.
10. Best layer, owned by an Indian resident of the United Provinces. Raja of Mursan's White Leghorn pullet. Cup presented by the U. P. P. A.
11. Best consecutive layer, irrespective of weight of eggs. Won by Mr. Fida Husain's cross Leghorn and Indian country bred pullet who laid 61 eggs in 66 days. Cup presented by the U. P. P. A.
12. Best layer, Australorp. Same as No. 1. Cup presented by the U. P. P. A.

DETAILS OF COMPETITION.

Statement showing the performance of pullets entered for the competition.

Owner	Breed	Pen No.	No. of 1st grade eggs laid, i.e., 2 oz. or over	No. of 2nd grade eggs laid, i.e., 1 1/4 oz. to 2 oz.	Gross total	Total to score	REMARKS
W. Bradbury, Progressive Poultry Farm, Tottington, Bury, England	White Leghorn	2	34	11	45	42.8	Winner of special Nos. 7 and 9.
		3	43	31	74	67.8	
	White Wyandotte	4	9	59	68	56.2	
		5	36	20	56	52	
H. Coles, Tottington, Bury, England	White Leghorn ..	7	47	7	54	52.6	
		8	34	23	57	52.4	
		50	43	14	57	54.2	
F. R. Welch, Dowles Poultry Farm, Bewdley, G. W. Ry., England	Light Sussex ..	11	58	13	71	68.4	
		12	37	nil	37	37	
		13	30	1	31	30.8	
		14	32	nil	32	32	
D. Freeland, Co. Down, Ireland	White Wyandotte	17	59	nil	59	59	
		18	60	1	61	60.8	
Lady Anderson, Harrold Priory, Sharnbrooke, Beds, England	Light Sussex ..	20	57	nil	57	57	Winner of special Nos. 2 and 8.
		21	67	nil	67	67	
		22	68	1	69	68.8	
Capt. Greenway ..	Rhode Island Red	24	58	nil	58	58	
		25	25	nil	25	25	
Capt. F. Mayo, Sirmoor State Forces, Nahan, Punjab	White Leghorn ..	26	55	9	64	62.2	
		27	47	2	49	48.6	
		28	58	nil	58	58	
		29	35	4	39	38.2	
Master Charters, Amballa City	White Leghorn ..	30	56	nil	56	56	Winners of special No. 5.
		31	59	2	61	60.4	
		32	46	6	52	50.8	
		33	60	3	63	62.4	
W. D'Cruze, P. W. I., Haripur, Hazara, N. W. F. P.	Rhode Island Red	34	33	nil	33	33	
		35	50	nil	50	50	
		36	47	7	54	52.4	
		37	50	1	51	50.8	
U. P. Poultry Association, Lucknow	Black Leghorn ..	38	60	1	61	60.8	
	White Leghorn ..	39	46	3	49	48.4	
	White Leghorn ..	40	50	5	55	54	
	Australorp ..	41	43	19	62	58.2	
C. Lawrie, Government Telegraph Office, Jhansi	White Leghorn ..	42	1	nil	1	1	
		43	45	10	55	53	
		44	29	32	61	54.6	
		45	45	5	50	49	

DETAILS OF COMPETITION.—*concl'd.*

Owner	Breed	Pen No.	No. of 1st grade eggs laid, i.e., 2 oz. or over		No. of 2nd grade eggs laid, i.e., 1½ oz. to 2 oz.		Gross total	Total to score	REMARKS
Mrs. Richardson, Nahan, Punjab	Australorp ..	46	46	9	55	53·2	Winner of special Nos. 1, 3, 6 and 12.		
		47	10	7	17	15·6			
		48	27	20	56	50·2			
		49	9	68	77	63·4			
A. C. Bullmore, Mount Road, Madras	White Leghorn ..	52	58	nil	58	58			
		53	53	2	55	54·4			
		54	36	6	42	40·8			
		55	42	10	52	50			
Mrs. Muir, Lucknow ..	Rhode Island Red	60	51	2	53	52·6			
		61	57	1	58	57·8			
		62	38	nil	38	38			
R. K. Mitra, Lucknow ..	White Leghorn ..	68	47	nil	47	47			
		69	55	nil	55	55			
Maqsd Ali Khan, Kailas-pur, Saharanpur	White Leghorn ..	70	15	15	30	27			
		71	1	35	36	29			
A. E. Slater, Etah ..	Black Leghorn ..	74	40	nil	40	40			
		75	30	nil	30	30			
		76	48	2	50	49·6			
		77	18	nil	18	18			
Mission Poultry Farm, Etah	White Leghorn ..	78	54	1	55	54·8			
		79	39	5	44	43			
		80	50	nil	50	50			
		81	52	2	54	53·6			
Mrs. K. Johnson, Wingfield Park, Lucknow	Brown Leghorn ..	82	40	15	55	52	Winner of special No. 4.		
	White Leghorn ..	83	40	3	43	42·4			
		84	45	nil	45	45			
		85	58	5	63	62			
Fida Husain, Court of Warts, Bara Banki	Brown Leghorn crossed Desi ..	92	1	62	63	50·6	Winner of special No. 11 laying 35 eggs consecutively and 61 eggs in 66 days.		
Raja Bahadur, Mursan, U. P.	White Leghorn ..	94	58	2	60	59·6	Winner of special No. 10.		
	Black Leghorn ..	95	51	3	54	53·4			
	White ..	96	56	nil	56	56			
Civil Veterinary Department, Lucknow	White Leghorn	97	46	nil	46	46			
		98	36	..	36	36			
Mrs. Toomey, Champaran	99	1	Died early in test.		
	Fida Husain, Bara Banki	White Leghorn ..	93		4	
								1	

Sixteen birds were withdrawn or refused that originally entered.

[MRS. A. K. FAWKES.]

SOIL ACIDITY AND PLANT DISTRIBUTION.

AN important series of studies on the hydrogen ion concentration of the soil and its relation to plant distribution has been published by Carsten Olsen (*Compt. rend. Lab. Carlsberg*, XV, 1923). These studies deal with the hydrogen ion concentrations of a series of Danish soils covered by natural vegetation, the observed range being from pH 3.4 to 8.0. The composition of the vegetation is found to be very closely correlated with the hydrogen ion concentration of the soil, and the author considers that the distribution of the more important species may be largely determined by this factor. The number and density of species in a given place are also found to be greatest when the soil reaction approaches neutrality. Olsen further points out that the vegetation of alkaline soils poor in mineral nutrients bears no resemblance to that of very acid soils poor in nutrients. This section of the paper is very impressive in its wealth of data, and it includes exhaustive tables showing vegetation composition in relation to pH and also a large number of partial soil analyses. Only those who have used the field methods employed by Olsen can really appreciate the extent and thoroughness of his investigations.

The author then deals with the growth of typical indicator species in water cultures. Species normally growing on acid soils are found to show best growth in nutrient solutions with a reaction of about pH 4.0. On the other hand, plants normally growing on neutral or alkaline soils show most vigorous growth in culture media of about pH 6 to 7. In these media the plants of acid soils do not thrive and become chlorotic. Olsen further examines the theory of Hartwell and Pember that soil acidity may be associated with the toxicity of aluminium ions. Though aluminium was found to be toxic to barley the theory appeared not to be valid for plants of alkaline soils in general. Further, while his observations confirm the idea that acid soils as a whole produce ammonia rather than nitrates, Olsen's experiments show no evidence for the supposition that the plants normally growing on acid soils utilize ammonia and not nitrates, or that the plants of alkaline soils can only utilize nitrates. **Both nitrates and ammonia appear to have the same value as sources**

of nitrogen in the cases examined, and, moreover, nitrification may be much more active in acid soils than is commonly supposed, as rapid nitrification existed in soils as acid as pH 4.4.

This valuable paper should be in the hands of all those interested in soil acidity and plant growth. [*Nature*, No. 2797.]

* * *

THE WORLD'S DAIRY CONGRESS.

THE World's Dairy Congress will hold its opening session this year at Washington, D. C., on 2nd and 3rd October, adjourn to Philadelphia, Pa., for 4th October, and continue at Syracuse, N. Y., from 5th to 10th October in co-operation with the National Dairy Exposition. The opening session will include discussions of some interesting papers dealing with the broadest international topics, scientific, economic and humanitarian, with addresses by distinguished speakers from several countries. A reception, a dinner and visits to research laboratories, public buildings and historic places will be a few of the activities in this city. The programme at Philadelphia will include demonstrations of methods and results of health work with school children and with civic and industrial groups done under the leadership of the National Dairy Council. At Syracuse the seventeenth annual National Dairy Exposition will open upon the arrival of the World's Dairy Congress delegates and continue until 13th October. The mornings will be devoted to sessions of the Congress and the afternoons to a study of the milk industry as presented at the Exposition with its competitive exhibits of dairy cattle and dairy products, its displays of labour-saving machinery and scientific appliances and health activities. Evenings will be devoted to meetings of national associations and various groups. On the evening of 10th October, there will be an international banquet in honour of the delegates. A number of excursions, designed to present the most modern developments in cattle-breeding, milk-producing, milk-handling, dairy products and manufacturing and dairy machinery, as well as to show many places of historic and scientific interest, will be arranged for the benefit of delegates. Three excursions of greater length

will be offered in advance of the Congress and one excursion of from four to five days' duration after the Congress.

* * *

UNITED PROVINCES POULTRY ASSOCIATION.

THE third annual report of the United Provinces Poultry Association records considerable expansion in its educational and commercial work. The receipts of the Association's central farm in Lucknow practically make the farm self-supporting and cover among other items the salary of Rs. 300 per month paid to the farm manager which, if the farm were a private concern, would be profit to the owner-manager. When it is realized that an income of Rs. 10,922 was obtained during 1922-23 from only 100 hens kept on the farm, it will be seen that there is money in the industry. The Association has ten smaller farms in the United Provinces, and from these centres a good deal of assistance is being given to the poorer classes of Indians by the distribution of poultry and eggs for setting either free or at a nominal price. Poultry shows and the annual egg-laying competition have almost become permanent features of the Association. It is gratifying to note that many Indians are opening poultry farms on their own account in parts of the province, and that as many as 13 students went through the course of instruction provided by the Association during the year under report.

* * *

MEXICAN MALVAVISCO PLANT AS SUBSTITUTE FOR JUTE.

THE discovery of a new fibre known as malvavisco, which is said to be a substitute for jute, is announced by the Industrial Experiment Laboratory of the Mexican Department of Commerce and Industry. The malvavisco plant grows abundantly in the humid level lands near the rivers and at present is employed in Vera Cruz for making brooms. Prolonged experiments, writes the United States Assistant Trade Commissioner at Mexico City, have shown this plant to possess qualities similar to jute and the cost of extracting the fibre to be small. The fibre has a silky appearance and has been woven into cloth with excellent results. [*Jour. Royal Soc. of Arts*, No. 3682.]

BLENDING INDIAN AND AMERICAN COTTONS.

THE following extract from the *Textile World* (LXIII, No. 12, 1923) is of some interest despite certain obvious inaccuracies in the description of Indian cottons. This confirms other reports of the extended demand for Indian long staple cottons for export this year :—

“ *Technical Editor* :—Lately I have noticed a considerable amount of Indian and Chinese cotton being offered in this country. As I understand it, English mills use this cotton in a blend with American cotton. I would appreciate it if you would write me any information you may have as to the proper method of working Indian cotton with American cotton and how the Indian cotton should be best mixed with American cotton.

“ We assume that you do not refer to rough Indian and Chinese cottons that are regularly used in this country by blanket and flannel manufacturers, and that average not over $\frac{5}{8}$ inch in length.

“ Owing to the high price of American cotton considerable quantities of smooth Indian and Chinese cottons have been imported this season, length averaging about $\frac{7}{8}$ inch, but occasionally running $\frac{7}{8}$ to 1 inch. Most of these cottons are rather rough and are somewhat similar to the Texas cottons grown around Corpus Christi.

“ The only Chinese cotton that compares at all closely with American $\frac{7}{8}$ inch to 1 inch is, we believe, called Tien Tsin. This could be mixed with any similar length of American cotton in the same way that American cottons would be blended. The longest of the Indian cottons is a Madras cotton termed Tinnevely, and a Surat termed Broach. These average $\frac{7}{8}$ inch in length and occasionally run $\frac{7}{8}$ to 1 inch. Considerable Surat and Madras cotton is grown from Egyptian and American seed and averages $\frac{7}{8}$ to 1 inch in length, and many of these longer Indian cottons can be blended with similar lengths of American, or processed separately if the desired break and feel in the finished yarn can be thus obtained.

“ We have run across very few of these long Chinese and Indian cottons in the local market, as they are being used in

larger quantities than ever by English and European spinners in place of American.

“In a general way it may be stated that the blending of short Indian and Chinese cottons with American cottons does not in any way differ from the blending of American cottons and wastes of similar lengths. The shortest of these cottons are best handled by the wool system of carding, using a mule or Whiting frame for spinning. The latter is the system used by most of the blanket manufacturers in this country to spin rough Indian and Chinese cotton.

“If we are correct in assuming from your inquiry that you are looking for the cheapest possible substitute for American cotton about $\frac{7}{8}$ to 1 inch in length, we would state that this can be found in Egyptian linters. Large quantities of these have been imported this season and thousands of bales have been shipped South to be mixed with low grade American cotton by companies operating machining plants and we assume that its identity is then lost. Africa is linters from Egyptian Uppers and the No. 1 grade could have been imported in January at 12 to 12½c. Scarto is linters from Egyptian Sakelarides and the No. 1 grade could have been imported in January at around 18c. Sekina is a low grade Egyptian cotton of mixed staple that is sometimes sold as short Sakelarides; this cotton could have been landed in January within a range of 19 to 22c. according to grade.”

Importations of Indian and Chinese cottons into America (U.S.A.).
Equivalent 400-lb. bales.

				Chinese	Indian
Half-year ending	January 31,	1923.	(Export from		
	India to U. S. A.)		6,832
Year ending	July 31,	1922	..	19,454	about 12,000
	Do.	1921	..	18,403	10,611
	Do.	1920	..	71,481	17,948
	Do.	1919	..	13,589	3,616
	Do.	1918	..	48,705	8,870
	Do.	1917	..	45,079	4,825
	Do.	1916	..	44,740	5,268
	Do.	1915	..	32,039	9,806
	Do.	1914	..	25,965	9,811
11 months ending	July 31,	1913	..	21,886	4,449

CHINESE COTTON.

THE Shanghai Correspondent of *The Manchester Guardian Commercial* (VI, No. 18) writes :—

“The old order changeth, yielding place to new.” We are living in special times. During the past few months the Shanghai merchant has experienced a crop of surprises—record prices for many exportable articles, scarcity of commodities in spite of reports of good crops in the interior, and a host of other interesting and vexatious incidents. All this probably will pale before the extraordinary fact that the United States has been purchasing Chinese raw cotton—an unheard of thing in the whole of the history of the cotton trade of China. Prejudices die hard in this world, but the prejudice of the American manufacturer against the employment of Chinese cotton for spinning purposes appears to be going.

American manufacturers have been good buyers of China cotton for blanket purposes, but it has been coarse fibre such as is grown in the Hankow district and round the Han river. Normally the demand for the United States for this coarse quality averaged about 25,000 bales of four piculs each. During the war America took about 35,000 bales a year. In 1919 the exports to the States reached 49,000 bales, but in 1920 she took only 3,000 bales while in 1921 the shipments further declined to 700 bales, or 3,000 piculs. Since the beginning of the present cotton season 3,000 to 4,000 bales have been exported.

In striking contrast to this is the fact that since November we have shipped from Shanghai 10,000 to 15,000 piculs of spinnable cotton, the first shipment of the better staple going to New York from here last November. Messrs. Fearon, Daniel and Co. bought 10,000 piculs in the Shanghai market for shipment to New York for spinning purposes. It is stated that they are still in the market for more.

HIGH PRICES AND ADULTERATION.

Very few people are aware of the work done in the States by a local cotton merchant in bringing before American millowners the importance of Chinese cotton as a substitute for American in spinning. A good many, when they learnt of the object of Mr. A. B. Rosenfeld's

mission to the United States last September, were inclined to scoff at the idea. The attitude of the millowners when approached did not inspire much hope, though it was pointed out to them that the spinning quality of the seven-eighths to one inch Chinese staple would answer for the 20's. A great deal, of course, depends at present upon the verdict of the American textile manufacturers. Should the cotton answer their requirements, there is no doubt that we shall see the introduction of a very big factor in the Shanghai market outstripping Japan in the rush to buy supplies. It must be admitted that the high price of American cotton has induced the American buyer to take the present chance. There is a difference to-day of $3\frac{1}{2}$ to 4 cents gold per pound between the two grades. The situation is pregnant with great possibilities, possibly not this season, but in future ones.

There is great difficulty at the moment in getting supplies of Chinese raw cotton unadulterated. The Chinese are holding back the good stuff, and there is a tendency to exact higher values than those obtaining on the market for the right quality. There is a strong suspicion that the Shanghai mills are paying higher prices for the long staple than the exporters. It is the high prices that are causing the adulteration. Arrivals of cotton from the producing districts in the interior into Shanghai are extremely small. For instance, there are some 52 buying houses in the Nantao district. At this time of the year the daily receipts used to amount to between 3,000 and 4,000 piculs, whereas now only 500 to 600 piculs are being marketed a day. The conclusion is that the cotton crop this season was nothing like what it has been pictured to be. On the other hand, it is quite possible that the Chinese agriculturist, who has had a prosperous season, may not be in need of hard cash, and is content to hold on to his stocks until prices appreciate further.

The Shanghai cotton mills in recent weeks have bought heavily of Indian cotton, having contracted since last December for 50,000 to 75,000 bales.

It is quite likely that the local industry is beginning to realize the folly of depending upon supplies of Chinese cotton and is laying in stocks of Indian.

The final outturn of this season's China crop, on the whole, is about 70 per cent. of normal. This conclusion, however, may not be altogether correct in this non-statistical country. The exports of Chinese cotton from September 1921 to August 1922 amounted to 376,496 piculs and from September 1922 to December 1922, 207,927 piculs. Last year China imported from India 1,283,518 piculs against 1,328,046 piculs in the previous year, while the imports from the United States amounted to 125,575 piculs against 946,987 piculs in 1921. The reason for the reduced importation of American grades as compared with 1921 was the high prices quoted for American compared with the Chinese staple.

*
* *

COTTON RESEARCH.

THROUGH the courtesy of the British Cotton Industry Research Association, the Secretary of the Indian Central Cotton Committee has sent the following abstracts for publication :—

COMPOSITION OF COTTON WAX.

Further experiments on the constituents of raw cotton have confirmed the previous contention that the raw cotton hair contains much more benzene-soluble substance than can be extracted in the ordinary way. The new results show that only a portion of the total wax is present on the exterior of the hair. The rest of the wax has not been located but it is conjectured that it may be present between the concentric sheaths of the hair substance and thus escape the action of the solvent. The whole of the benzene-soluble substance is only obtained when these barriers are broken down by mechanical means or by destroying the cellulose by an acid of suitable strength. It is shown to be possible to isolate and identify some of the benzene-soluble constituents of raw cotton by working on comparatively small amounts of cotton. Cotton is shown to contain, in addition to the cotton wax of Schunck (m. p. 86°C.), a considerable proportion of another substance having a slightly different chemical composition, melting at 79°C., and being more readily soluble in cold benzene than the former. [*Jour. Soc. Dyers*, 1923, 39, 73-77. E. KNECHT and G. H. STREAT.]

BENNETT COTTON HARVESTER.

The operations of picking, cleaning, ginning, and baling are combined in this machine. The parts of the machine are mounted on a steel frame carried on caterpillar tractors and the power unit consists of a 60 horse-power petrol engine. The machine is provided with 10 lines of vacuum picker hose and the cotton bolls are discharged thence into a cleaning box, which, in turn, delivers to the gin. The lint cotton then passes to a condensor which deposits the cotton in layers in the baling press. The seed is collected in a separate receptacle. In field operation the harvester straddles one row of cotton ; the plants in this row and the two adjacent rows are protected by fenders. The machine moves at a speed regulated according to the relative number of open bolls. Two outstanding advantages of the machine are :—(1) The gins can be kept in perfect order and as there is no need to run them at very high speeds there is very little fibre damage, (2) the gin and its attachments are so small that they can be thoroughly cleaned between harvesting any two crops so that the mixing of seed is prevented. [*Text. Rec.*, 1923, 40, No. 480, 77–81. W. WHITTAM.]

CULTIVATION OF COTTON IN SOUTH CAROLINA.

The results of fertilizer tests with cotton grown continuously for 13 crops on a Cecil sandy loam typical of the Piedmont section of South Carolina are summarized. Applications of fertilizer carrying large amounts of nitrogen or phosphoric acid seem to have a residual effect lasting for several years. Phosphorus is indicated as the first limiting factor on the particular soil and nitrogen a close second. Potash is considered of doubtful value. Lime reduced yields slightly when used with acid alone and caused a slight increase when employed with a complete fertilizer. Its use on this soil for the production of cotton alone would not seem profitable. Acid phosphate with blood gave better results than any other combination of two elements. Eight tons of stable manure and from 352 to 848 lb. of acid phosphate produced the highest yields, 1,312 lb. of seed cotton per acre, of the several treatments used. Plats receiving heavy applications of acid phosphate and nitrogen, with generally

some potash, maintained yields to the end of the experiment. It is difficult to maintain the yield of cotton on this soil by the use of commercial fertilizer alone. [*Exp. Sta. Rec.*, 1922, **47**, 736; from *South Carolina Sta. Bull.* 211, 1922, p. 22. C. P. BLACKWELL.]

GERMINATION OF COTTON SEED.

The results of experiments on germinating cotton seeds in different types of soil, either with the seeds in direct contact with various fertilizers or with the fertilizers mixed with the soil in which the seeds are planted, indicate that germination is generally inhibited by the presence of fertilizers. This inhibition is greater when the fertilizer is in direct contact with the seed and is generally proportional to the amount of fertilizer used; it is greater with the more soluble mineral fertilizers. The inhibiting action is apparently due to a retarding influence upon the osmotic absorption of water from the soil by the seed in the case of the soluble mineral fertilizers or to the stimulation of the growth of fungi which are injurious to the root systems of the young seedlings, in the case of organic fertilizers such as cotton seed meal. Borax in small amounts exerts a marked inhibiting effect upon root growth which is not counteracted by the addition of ferrous sulphate in solution. [*Jour. Amer. Soc. Agronomy*, 1923, **15**, 66-73. M. E. SHERWIN.]

CLINGING POWER OF COTTON HAIR.

The author emphasizes the importance of character as well as staple length, evenness and strength of fibre in buying cotton for manufacturing purposes and asserts that "drag" (presumably the clinging power), which has a direct bearing on yarn strength, receives too little consideration. Only about 6 per cent. of the actual tensile strength of the cotton hairs in a cross section of yarn is effective in the strength of the yarn, the remainder being lost in the slipping of the hairs past one another. For this reason the tendency of the hairs to bind together when spun into yarns is extremely important. [*Text. World*, 1923, **63**, 456. J. McDOWELL.]

**PERSONAL NOTES, APPOINTMENTS AND TRANSFERS,
MEETINGS AND CONFERENCES, ETC.**

MR. J. R. HADDOW has been appointed Veterinary Officer at the Imperial Bacteriological Laboratory, Muktesar.

* * *

MR. P. V. ISAAC, B.A., D.I.C., M.Sc., F.E.S., Second Entomologist (Dipterist), Agricultural Research Institute, Pusa, was on leave on average pay from 3rd to 17th May, 1923, Mr. G. R. Dutt, B.A., officiating.

* * *

DR. R. V. NORRIS, Government Agricultural Chemist, Madras, has been permitted to retire from the Indian Agricultural Service, from the date of expiry of his leave.

* * *

MR. R. C. BROADFOOT, N.D.A., C.D.A., on return from leave, has been appointed Deputy Director of Agriculture, VI Circle, Madura.

* * *

MR. SAADET-UL-LAH KHAN, M.A., B.Sc., Probationary Deputy Director of Agriculture, Madras, has been appointed to work in the VI Circle under Mr. Broadfoot.

* * *

MR. B. RAMAYYA GARU has been appointed to act as Deputy Director of Agriculture, Madras, *vice* Mr. H. C. Sampson on leave.

* * *

MR. K. HEWLETT, O.B.E., Principal, Veterinary College, Bombay, has been granted leave on average pay for four months and twenty-two days from 1st August, 1923. •

CONSEQUENT upon the appointment of Mr. D. Milne, B.Sc., as Officiating Director of Agriculture, Punjab, Mr. Agha Yusuf Ali Khan has been appointed to officiate as Economic Botanist to Government, Punjab, and Lala Chunilal, M.Sc., has been appointed to officiate as Second Economic Botanist and take over charge of the duties of Professor of Botany in addition to his own duties.

* * *

THE services of Sardar Sahib Kharak Singh, Associate Professor of Agriculture, Punjab Agricultural College, Lyallpur, have been placed at the disposal of the Chief Engineer, P. W. D., Irrigation Branch, Punjab, from 23rd May, 1923, in connection with the abstraction of results from crop irrigation observations recorded by the Irrigation Department.

* * *

THE two months' leave on average pay granted to Khar Sahib Maulvi Fateh-ud-din, Personal Assistant to the Director of Agriculture, Punjab, has been extended by one month.

* * *

MR. C. J. N. CAMERON, Officiating Veterinary Adviser to the Government of Burma, has been granted combined leave for two years and four months from 29th August, 1923.

* * *

MR. A. BLAKE, Veterinary Officer of the Corporation of Rangoon, has been appointed Veterinary Adviser to the Government of Burma, as a temporary measure, from 1st September, 1923.

* * *

MR. F. J. PLYMEN, A.C.G.I., Agricultural Chemist, Central Provinces, has been appointed Director of Agriculture, Central Provinces, *vice* Dr. D. Clouston, C.I.E., on other duty.

* * *

MR. A. R. PADMANABHA IYER, B.A., Extra Assistant Director of Agriculture, Nagpur, has been appointed to officiate as Agricultural Chemist, Central Provinces, *vice* Mr. Plymen officiating as Director of Agriculture, Central Provinces.

MR. S. G. MUTKEKAR, B.A.G., M.Sc., Deputy Director of Agriculture, Western Circle, Central Provinces, was on privilege leave for two months from 6th June, 1923.

* * *

THE eleventh meeting of the Indian Science Congress will be held at Bangalore from 14th to 19th January, 1924.

HIS HIGHNESS THE MAHARAJA OF MYSORE has kindly consented to be the Patron of the Meeting, and SIR ASHUTOSH MOOKERJEA will be President.

The following Sectional Presidents have been appointed :--

Agriculture.

MR. B. C. BURT, M.B.E., B.Sc.,
Secretary, Indian Central Cotton
Committee.

Physics and Mathematics.

DR. C. V. RAMAN, Sir Taraknath
Palit Professor of Physics,
University College of Science,
Calcutta.

Chemistry.

DR. E. R. WATSON, Principal, Tech-
nological Institute, Cawnpore.

Zoology.

PROFESSOR K. W. BAHL.

Botany.

DR. S. P. AGHARKAR, Sir Rash
Bihari Ghosh Professor of
Botany, University College of
Science, Calcutta.

Geology.

MR. H. BOSWORTH SMITH.

Medical Research.

LT.-COL. S. R. CHRISTOPHERS,
C.I.E., O.B.E., I.M.S., Offg.
Director, Central Research
Institute, Kasauli.

Anthropology.

RAO BAHADUR L. K. ANANTA-
KRISHNA AYYAR.

The Honorary Local Secretaries are PROFESSOR F. L. USHER, Central College, Bangalore, and MR. S. G. SASTRY, Secretary, Board of Scientific Advice, Bangalore. DR. J. L. SIMONSEN, Forest Research Institute and College, Dehra Dun, is the Honorary General Secretary.

Review

Report on an Enquiry into Working Class Budgets in Bombay.—

By G. FINDLAY SHIRRAS. Pp. 299 + 6 charts. Printed at the Bombay Government Central Press. Price, Rs. 3-14.

WE congratulate Mr. Findlay Shirras on his interesting and instructive report on the working class budgets in Bombay, containing statistics of great economic interest relating to that section of the community about which information is most required. The enquiry extended from May 1921 to April 1922, and no less than 3,076 budgets—2,473 working class family budgets and 603 single men's budgets—have been tabulated, which is a larger number than dealt with in any other enquiry for any single city at one particular period. The extensive method of collecting the data was generally followed, though the intensive method, which necessitates a minute study of the working class family by some person or persons intimately acquainted with it, was also to a limited extent followed, the subjects of primary investigation being the size and earnings of the family, the cost and consumption of food, fuel and lighting, clothing, miscellaneous articles, the cost of house-rent and housing conditions.

The average working class family in the city of Bombay consists of 4·2 persons, while its monthly income averages Rs. 52-4-6. Of the latter, 56·8 per cent. is spent on food, 7·4 on fuel and lighting, 9·6 on clothing, 7·7 on house-rent, and 18·5 on miscellaneous expenditure. It is interesting to note that the proportionate percentage expenditure on food is nearly the same as in Italy and Argentina, but less than that in the more industrially advanced countries, such as the United States and the United Kingdom. It is also below that of the East Indies (for East Indians in Trinidad), Egypt and China. The quantity of cereals consumed by the industrial workers in Bombay, which forms 60·2 per cent. of the diet bill, compares

favourably with the maximum prescribed by the Bombay Famine Code, but it falls below the scale prescribed for jails. It must, however, be remembered that the family budgets include other articles of comparatively high nutritive value, such as sugar, sweetmeats, etc., which do not enter into either the Famine or Jail Codes. Approximately 47 per cent. of the families are shown to be in debt, the average indebtedness extending to an equivalent of two and a half months' earnings. The details of housing conditions and the spread of education are equally arresting, and the comparative figures given of the position in other countries show why the Indian labour is what it is and what considerable lee-way has to be made up to improve the situation.

The interspersing of the book with half-a-dozen attractive charts and the addition of an exhaustive index have considerably enhanced the utility of the book. We commend the Report for serious study to the notice of not only social workers and students of Indian economics but to all interested in public welfare. [EDITOR.]

Correspondence

THE CATTLE PROBLEM IN INDIA.

THE EDITOR, *The Agricultural Journal of India.*

SIR,—I have read with interest Dr. Leake's article on the cattle problem of the United Provinces in the last number of the Journal (XVIII, 4, p. 330).

I do not wish again to go over the ground that has been so often covered but my attention is particularly drawn to a remark made on page 337. It is there said, "unfortunately such a combination is not attainable and the perfect dual purpose breed does not exist."

I am not disputing the second proposition so far as India is concerned (and meaning by "dual purpose" a combination of draught and milk, not meat and milk), but I join issue with the first. Is there authority for it? Certainly nothing that I have seen in 22 years amongst Indian cattle would induce me to lay it down.

The milk-producing capacity of Indian breeds of cattle may, without including extreme cases, be accepted as varying between 1,000 lb. and 7,000 lb. milk in 300 days. I see no reason why the best draught qualities of any cattle now found in Northern India should not be combined with 7,000 lb. of milk within a moderate time, if breeding with that object were seriously taken in hand, and, granted more time, I would undertake to combine them with very much more milk still.

The most serious defect of Indian draught cattle, in my experience, is lack of "heart" or mettle, and I would venture to predict that whoever takes this matter up will find it more difficult to find in North Indian breeds, and fix in his strains, that high courage which induces an animal to pull till he drops, which is easily provided by a dash of European blood, though that remedy is not open to us on account of defects that accompany, than he will to engraft high milk yielding capacity.

KASAULI ;
1st August, 1923. }

Yours faithfully,
J. MATSON.

RIPENING OF COCONUT FLOWERS.

THE EDITOR, *The Agricultural Journal of India.*

SIR,—In a previous letter I communicated to you the results of my observations on the ripening of coconut flowers in Akyab, Burma, showing that the view that the female flowers do not open till all the male flowers in the same inflorescence have been shed was not universally true at Akyab. These results, however, did not derive any support from very careful observations made at the Kasargod Coconut Station, and it was doubted whether my observations were on normal male flowers or on some abnormal ones which do not open, and whose pollen, therefore, does not stand any chance of pollinating the female flowers. Subsequently, however, I have noted more cases at Akyab where male flowers continued to open after some or all the female flowers in the same inflorescence had ripened. And recently I have observed a similar case in Singapore on the Kelapa Puyoh variety of *Cocos nucifera*.

The behaviour of the coconut flowers in Malaya, as studied by Messrs. Jack and Sands in the *Malayan Agricultural Journal*, X, No. I, pp. 4-12, will be found interesting in this connection :—

“ In the warm humid atmosphere of the lowlands of Malaya, coconuts appear to behave differently (from the highlands of Ceylon). The length of duration of the male phase is curtailed ; while the duration of the female phase would appear to be longer in both tall and dwarf trees ; but the most striking difference is the fact that in Malaya the female phase not only begins, but most frequently ends before, or at the same time, as the male phase, thus rendering self-pollination the rule instead of being an occasional chance occurrence.”

By bagging unopened inflorescence they have succeeded in obtaining fruits.

BOTANIC GARDENS, SINGAPORE ; }
23rd June, 1923. }

Yours faithfully,
C. X. FURTADO.

NEW BOOKS

ON AGRICULTURE AND ALLIED SUBJECTS

1. Factors affecting the control of the Tea Mosquito Bug (*Helopeltis theivora*, Waterh.). Pp. iv+260+44 diagrams. (Calcutta: Indian Tea Association.) Price, 3s. 6d.
2. Insecticides and Fungicides, Spraying and Dusting Equipment: A Laboratory Manual with Supplementary Text Material, by O. G. Anderson and F. G. Roth. Pp. xvi+390. (New York: J. Wiley & Sons, Inc.; London: Chapman and Hall, Ltd.) Price, 15s. net.
3. Text-book of Pomology, by J. H. Gourley. Pp. xv+380+8 plates. (London: Macmillan & Co.) Price, 12s. net.
4. Potato: its culture, uses, etc., by W. Stuart. Pp. 518. (Philadelphia and London: J. B. Lippincott Co.) Price, 12s. 6d.
5. The Diseases of the Tea Bush, by T. Petch, B.A., B.Sc. (London: Messrs. Macmillan & Co., Ltd.) Price, 20s. net.

THE following publications have been issued by the Imperial Department of Agriculture in India since our last issue :—

Memoirs.

1. I—History of the Operations against Bud-rot of Palms in South India. II—Inoculation Experiments with *Phytophthora palmivora* Butl. on *Borassus flabellifer* Linn. and *Cocos nucifera* Linn., by W. McRae, M.A., B.Sc. (Botanical Series, Vol. XII, No. 2.) Price, R. 1-4 or 2s.
2. Notes on Indian Muscidæ, by R. Senior-White, F.E.S. (Entomological Series, Vol. VIII, No. 4.) Price, As. 12 or 1s.

Bulletin.

3. Observations on the Morphology and Life-cycle of *Filaria recondita* Grassi, by M. Anant Narayan Rao. (Bulletin No. 144.) Price, As. 6.

VOL. XVIII, PART VI

November, 1923

THE AGRICULTURAL JOURNAL OF INDIA



EDITED BY

The Agricultural Adviser to the Government of India

PUBLISHED FOR

THE IMPERIAL DEPARTMENT OF AGRICULTURE IN INDIA

BY

THACKER, SPINK & CO., CALCUTTA,

W. THACKER & CO., 2, CREED LANE, LONDON

Price R. 1-8 or Two Shillings

Agents for the Sale of Government Publications

IN EUROPE

- Constable & Co., 10, Orange Street, Leicester Square, London, W.C.
Kegan Paul, Trench Trübner & Co., 68-74, Carter Lane, E.C., and 25, Museum Street, London, W.C.
Bernard Quaritch, 11, Grafton Street, New Bond Street, London, W.
P. S. King & Sons, 2 & 4, Great Smith Street, Westminster, London, S.W.
H. S. King & Co., 65, Cornhill, E.C., and 9, Pall Mall, London, W.
Grindlay & Co., 54, Parliament Street, London, S.W.
Luzac & Co., 46, Great Russell Street, London, W.C.
W. Thacker & Co., 2, Creed Lane, London, E.C.
T. Fisher Unwin, Limited, 1, Adelphi Terrace, London, W.C.
B. H. Blackwell, 50 & 51, Broad Street, Oxford.
Deighton, Bell & Co., Ltd., Cambridge.
Oliver & Boyd, Tweeddale Court, Edinburgh.
E. Ponsonby, Ltd., 116, Grafton Street, Dublin.
Ernest Leroux, 28, Rue Bonaparte, Paris.
Martinus Nijhoff, The Hague, Holland.
Otto Harrassowitz, Leipzig.
Friedlander and Sohn, Berlin.

IN INDIA AND CEYLON

- Thacker, Spink & Co., Calcutta and Simla.
W. Newman & Co., Calcutta.
R. Cambay & Co., Calcutta.
S. K. Lahiri & Co., Calcutta.
B. Bannerjee & Co., Calcutta.
The Indian School Supply Depot, 309, Bow Bazar Street, Calcutta, and 226, Nawabpur, Dacca.
Butterworth & Co. (India), Ltd., Calcutta.
Rai M. C. Sarkar Bahadur & Sons, 75-1-1, Harrison Road, Calcutta.
The Weldon Library, 57, Park Street, Calcutta.
Standard Literature Co., Ltd., Calcutta.
Lal Chand & Sons, Calcutta.
Higginbotham, Ltd., Madras.
V. Kaliyanarama Iyer & Co., Madras.
G. A. Nathan & Co., Madras.
S. Murthy & Co., Madras.
Thompson & Co., Madras.
Temple & Co., Madras.
P. R. Rama Iyer & Co., Madras.
E. M. Gopalakrishna Kone, Madura.
Thacker & Co., Ltd., Bombay.
A. J. Combridge & Co., Bombay.
D. B. Taraporevala, Sons & Co., Bombay.
Mrs. Radhabai Atmaram Sagoo, Bombay.
Sunder Pandurang, Bombay.
Gopal Narayan & Co., Bombay.
Ramchandra Govind & Son, Kalbadevi, Bombay.
A. H. Wheeler & Co., Allahabad, Calcutta and Bombay.
N. B. Mathur, Superintendent, Nazir Kanun-i-Hind Press, Allahabad.
Rai Sahib M. Gulab Singh & Sons, Mufid-i-Am Press, Lahore.
A. Chand & Co., Lahore, Punjab.
Ram Krishna & Sons, Lahore.
Superintendent, American Baptist Mission Press, Rangoon.
Manager, the "Hitavada," Nagpur.
S. C. Tulankdar, Proprietor, Students & Co., Cooch Behar.
A. M. & J. Ferguson, Colombo, Ceylon.
Manager, Educational Book Depôts, Nagpur and Jubbulpore.*
Manager of the Imperial Book Depot, 63, Chandney Chank Street, Delhi.*
Manager, "The Agra Medical Hall and Co-operative Association, Ltd." (Successors to A. John & Co., Agra).
Superintendent, Basel Mission Book and Tract Depository, Mangalore.*
P. Varadachary & Co., Madras.*
H. Liddell, Printer, etc., 7, South Road, Allahabad.*
D. C. Anand & Sons, Peshawar.*
Ram Dyal Agarwala, 184, Katra, Allahabad.*
Manager, Newal Kishore Press, Lucknow.*

* Agents for the sale of Legislative Department Publications only.

CONTENTS

(VOL. XVIII, PART VI)

ORIGINAL ARTICLES

PAGE

SOME COMMON INDIAN BIRDS. NO. 24. THE BENGAL TREE-PIE (<i>Dendrocitta rufa vagabunda</i>)	T. Bainbrigg Fletcher, R.N., F.L.S., F.E.S., F.Z.S.; and C. M. Inglis, M.B.O.U., F.E.S., F.Z.S. ..	563
SOME ECONOMIC PLANTS OF THE NAGA HILLS ..	J. H. Hutton, C.I.E., M.A., I.C.S. ..	567
LINKAGE RELATIONS IN THE COTTON PLANT ..	K. I. Thadani, M.Sc. (Texas), B.Ag., F.L.S., F.R.H.S. ..	572
POLLINATION METHODS AMONGST THE LESSER MILLETS	W. Youngman, B.Sc.; and S. C. Roy, L.Ag. ..	580
FURNACES FOR THE MANUFACTURE OF Gur ..	H. R. Stewart, A. R. C. Sc. I., D.I.C., N.D.A.; and Sardar Sahib Kharak Singh, M.A. ..	584
THE MESQUITE (<i>Prosopis juliflora</i>) ..	W. Robertson Brown	596
THE CULTIVATION OF POTATO IN ITALY ..	G. S. Kulkarni, M.Ag. ..	599
CATTLE BREEDING	William Smith ..	604
A NOTE ON <i>Fusarium</i> WILT OF GRAM IN BURMA AND MEASURES TAKEN TO COMBAT IT ..	A. McKerral, M.A., B.Sc. ..	608

EXPERIMENTS ON WHEAT THRESHING AT LYALLPUR	H. R. Stewart, A. R. C. Sc. I., D.I.C., N.D.A. ; and D. P. Johnston, A.R.C.Sc.I., N.D.A. ..	614
---	--	-----

SELECTED ARTICLES

ROTHAMSTED AND AGRICULTURAL SCIENCE	621
DANISH AGRICULTURE AND THE HYGIENE OF THE NATION ..	634
COTTON PRODUCTION AND CO-OPERATIVES	639

NOTES

THE BOARD OF AGRICULTURE IN INDIA	646
A NEW SPRING-TOOTH HARROW	647
ROOT PRUNING OF THE MANGO PLANT	648
CAUSE AND CONTROL OF FIJI DISEASE OF SUGARCANE ..	651
NEED FOR FRESH COTTON FIELDS	653
CEARA COTTON	657
COTTON RESEARCH	658

PERSONAL NOTES, APPOINTMENTS AND TRANSFERS, MEETINGS AND CONFERENCES, ETC.	662
---	------------

REVIEWS

THE SCIENCE AND PRACTICE OF COCONUT CULTIVATION ..	665
KALIDE MURGHI KHANA (IN URDU): KEY TO POULTRY KEEPING ..	668
THE COTTON GROWING COUNTRIES: PRODUCTION AND TRADE ..	669

NEW BOOKS ON AGRICULTURE AND ALLIED SUBJECTS ..	671
--	------------

LIST OF AGRICULTURAL PUBLICATIONS IN INDIA FROM 1ST FEBRUARY TO 31ST JULY, 1923	672
--	-----

LIST OF ILLUSTRATIONS

The Bengal Tree-Pie (<i>Dendrocitta rufa vagabunda</i>) ..	Frontispiece
	Facing page
Plate XXI. Arid dusty road clothed with mesquites ..	596
„ XXII. A spray of mesquite beans and mesquite seedlings ..	597
„ XXIII. Varieties of gram, resistant and susceptible to wilt, at the Padu farm, Burma	612

**The following Original Articles will appear in our next issue
(January 1924).**

- SOME COMMON INDIAN BIRDS. No. 25. .. *T. Bainbrigge Fletcher,*
R.N., F.L.S., F.E.S.,
F.Z.S.; and C. M. Inglis,
M.B.O.U., F.E.S., F.Z.S.
- LINSEED (*Linum usitatissimum*) HYBRIDS .. *R. J. D. Graham, D.Sc.;*
and S. C. Roy, L.Ag.
- THE UTILIZATION OF INDIGENOUS PHOSPHATES
IN INDIA *C. M. Hutchinson, C.I.E.,*
B.A.
- KIKUYU (*Pennisetum clandestinum*): A NEW
PASTURE GRASS FOR INDIA *W. Robertson Brown.*
- IRRIGATED PADDY: A CONTRIBUTION TO THE
STUDY OF FIELD PLOT TECHNIQUE .. *Leslie Lord, B.A.*
- PROTECTION OF CABBAGE AND KNOLKHOL
SEEDLINGS FROM FLEA-BEETLES .. *P. V. Wagle, B.Ag.*
- THE PROBLEM OF POTATO STORAGE IN WESTERN
. INDIA *S. L. Ajrekar, B.A.*
- A FEW OBSERVATIONS ON PADDY (*Oryza sativa*)
CROSSING *G. S. Sharangpani, B.A.*



THE BENGAL TREE PIE (*DENDROCITTA RUFA VAGABUNDA*).

Original Articles

SOME COMMON INDIAN BIRDS.

No. 24. THE BENGAL TREE-PIE (*DENDROCITTA
RUF A VAGABUNDA*).

BY

T. BAINBRIGGE FLETCHER, R.N., F.L.S., F.E.S., F.Z.S.,
Imperial Entomologist ;

AND

C. M. INGLIS, M.B.O.U., F.E.S., F.Z.S.

THE true Crows, as anyone may observe, have tails which are much shorter than their wings, but many members of the great Crow family have tails much longer than their wings, and this latter group includes the Magpies and Tree-Pies, of which a dozen species occur within our limits, mostly in the Hill Districts of Northern India. The Tree-Pie, however, is rather a bird of the Plains, where it is sufficiently common to be a familiar object in most large gardens, although its curiously metallic cry, rather like the loud squeak from a rusty gate-hinge, if one may imagine a mellifluous squeak, is usually more evident than the appearance of the bird itself. Its most usual call is a sound which may be written *kok-lí, kok-lí*, but it has a great variety of notes, many of them charmingly melodious in character, others merely hoarse chattering volleys of sound. So far as appearance goes, the Tree-Pie can hardly be mistaken for any other bird found commonly in the Plains, being about eighteen inches long, of which two-thirds is tail, the bill black, the head, neck and breast sooty-brown, the body

chestnut-reddish, with some silver-grey on the wings, and the long tail greyish, darkest at the base and broadly tipped with black. During flight the tail is spread out and, as the tail-feathers are unequal in length, the middle feathers being the longest and the others decreasing in length to the outer pair, which are only about half the length of the middle ones, the expanded tail gives this bird a curious appearance when on the wing. Like many other birds, the Tree-Pie has split up into several local races, of which five have been given sub-specific names. Of these, however, three, distinguished by the blending of the colours of the head and back, are confined to Burma and need not be more than alluded to here. The two Indian forms, in which the colours of the head and back contrast strongly, are the Indian Tree-Pie (*Dendrocitta rufa rufa*) which is lighter both above and below and not nearly so richly coloured as the Bengal Tree-Pie (*Dendrocitta rufa vagabunda*) which is darker and more richly coloured both above and below. The former race is found throughout the whole of Southern India as far North as Orissa and in Sind, Afghanistan, and the Punjab as far as Garhwal. The Bengal race occurs from Garhwal to Eastern Assam, throughout the United Provinces, Bihar and Bengal, and is the form figured in our Plate. The habits of both these Indian races, however, are quite similar and both may be considered together under the general name of the Tree-Pie.

The Tree-Pie is a bold and intelligent bird, which goes about in pairs or in small parties, flying from one tree to another and continually prying about for insect or vegetable food. In the early morning especially it is often seen in trees on the hunt for insect food; it is a good climber and supports itself with its claws and tail, rather like a wood-pecker, on vertical or even overhanging stems and branches whilst it searches the crevices of the bark for small insects. Some of its food is obtained on the ground, but most in trees and bushes, and a very small proportion on the wing. The late C. W. Mason stated that "this bird is to a very large extent a vegetable feeder, though it does not apparently damage crops or planted seeds. It takes a variety of weed seeds and fruits of all kinds including all the common species of *Ficus*, ber fruit (*Zizyphus*

jujuba), mulberries, *Sissu* seeds, etc. Of cultivated fruits, when they are in season, it takes peaches, loquats, plantains, etc., and besides eating the fruit on the trees it will often knock off a considerable amount more. Not only does it thus damage the fruit, but it also breaks off small branches (which often contain fruit buds) of brittle-wooded varieties of trees when it alights on them, and is therefore not to be desired in a carefully kept orchard. Leaves and buds of various sorts are also eaten, but apparently only of wild plants. The Tree-Pie's insect food is very varied, but undoubtedly some preference is shown to caterpillars, principally Geometrids and some other smooth varieties—I have never known it touch a hairy one—to beetles, which are mostly Tenebrionids, and to a less extent to the common wasp, *Polistes hebræus* It does not as a general rule take crickets." It is fond of silk-worm caterpillars and, when it can obtain access to these, may be a nuisance to silk-worm rearers. The food, however, is very varied and one's impression is that it is more largely of an animal nature than Mr. Mason's records indicate. Lizards and spiders are greatly relished and a Tree-Pie will often make a regular practice of hunting around the verandah of a bungalow in the early morning to snap up any lizards or spiders which may be recovering from a surfeit on the insects attracted to the lights the night before. Mr. D'Abreu examined at Nagpur a bird whose stomach contained a mouse, a Buprestid beetle, a caterpillar and two Pentatomid bugs, and at Pusa I have seen one carrying a very fair-sized snake which I managed to make the bird drop and found it to be a *Tropidonotus stolatus*, upwards of two feet long; the snake when rescued was alive and active but bore marks of the bird's mandibles and would undoubtedly have been eaten. The Tree-Pie is also a confirmed robber of the nests of other birds, especially of doves, stealing and devouring the eggs and young of all the smaller birds. Like many other birds, the Tree-Pie has his good and bad points, but on the whole it is apparently beneficial.

The breeding-season is from February to July, from February to March in the South and from May to July in the North, but is not well-defined and eggs may be found both later and earlier

than the period normal to any particular locality. The nest is usually placed well up in a large tree but may at times be built in a thorn hedge, thorny bush or in a cactus clump. The nest is a not very large but rather untidy mass of twigs, roots and miscellaneous material, carelessly interwoven and lined with roots or at times with softer material. Three to five eggs are laid as a rule, most often four, rarely six, but in the South only two or three, and the eggs, which average about 29 by 22 mm., belong to two types, one pale greenish blotched and spotted with fuscous, the other pale reddish-white or salmon-colour with blotches of reddish and dark brown and other underlying blotches of lilac and neutral tint; the former type is the commoner in North Bihar. The young birds are fed almost entirely on caterpillars and perhaps also on fruit to some extent.

The Tree-Pie has not been given legal protection in any part of India. Apparently it is considered well able to look after itself. Being conspicuous, it rejoices in various names in different parts of the country; Stuart-Baker states that the Bengal race is called Bobalink by Europeans, but this name belongs rightly to an American bird and I have never heard it used in India, although it is to some extent descriptive of the Tree-Pie's note; in North Bihar the local vernacular name is *kokayā*, in Bengal it is also called *kotri*, *takka-chor* and *handi-chacha*, in North Cachar *kash-kurshi*, in Assam *khola-khoa*, in Hindi-speaking areas *maha-lat*, at Lucknow *mutri*, in Sind *mahtab* and *chand*, and in Telugu-speaking districts *gokurayi* and *kond-kati-gada*. It will be noted that many of these vernacular names are also expressive of the various calls uttered by this bird.

SOME ECONOMIC PLANTS OF THE NAGA HILLS.*

BY

J. H. HUTTON, C.I.E., M.A., I.C.S.,
Deputy Commissioner, Naga Hills, Assam.

I OUGHT at the outset to state that I am no botanist. The plants and trees subsequently mentioned have been identified for me by Mr. A. C. Tunstall of Toklai. I did not even collect them all myself, as Mr. H. G. Dennehy collected many of them and Mr. J. P. Mills others. The real justification of this paper is less that it may impart information than the hope that it may elicit it.

The area from which these plants come is that of the range of hills separating Assam from Burma, the highest peak of which is Sarameti—12,000 feet. The fauna, at any rate, of this area combines Himalayan with Burma types, a statement which applies to the human as well as other varieties, as the wild tribes inhabiting these hills are of exceedingly mixed origin. At the same time, they have probably changed little since Ptolemy wrote of their habitat as the "kingdom of nakedness" some 1,600 years ago. Some of the tribes still go stark naked in their villages and even when visiting the plains of Assam to trade.

The Chǎng Naga tribe has a tradition that the wearing of clothes began by the use of nets for the carrying of children by their mothers who needed both their hands for work in the fields. However this may be, it seems likely that the use of fibre preceded that of cotton in their case, as some villages which can get cotton do not spin or weave it, although they do spin and weave in fibres. These fibres are usually made from the covering of the stalk immediately under the bark. The fibres actually in use for making

* Paper read at the Botanical Section, Indian Science Congress, 1923.

cords and nets are obtained from the following plants among others :—

(1) *Hibiscus macrophyllus* Roxb., a small slender-stemmed tree growing in warm low land, but not in forest, and used for making slings to carry burdens with, and for rope to tie cattle.

(2) *Sterculia villosa*, an inferior sort of tree also usually found at low levels and in abandoned cultivation, but occasionally in forest also, and used for the same purposes as the preceding, and for coarse string bags.

(3) *Grewia macrophylla* Don., a small tree growing on cliffs and bearing white flowers in June, used for the same purposes as the last. The Ao Naga name is *lungpangsongtong*, meaning “ the precipice tree ”.

Finer net bags, fishing nets and net purses for carrying money are made from the fibre of (4) *Triumfetta pilosa* Roth., a straight-growing shrubby plant with one stem, found in recently abandoned fields and bearing a few large burrs.

Fishing nets, cords for various purposes and bow-strings are made from the fibre yielded by (5) *Villebrunea integrifolia* Gaud., a small tree growing in stoney ground at lowish elevations and usually near water. This fibre used to be used, according to tradition, for making thread and cloth, a tradition which also attaches among the Ao Nagas to (6) *Urtica parviflora* Roxb., a branched shrub with stinging-nettle leaves bearing a drooping spike of green flowers in August and generally found in places frequented by man.

A second nettle is (7) *Girardinia heterophylla* Dene., flowering in September with a long drooping spike of green flowers and habits like the preceding. It has a fine silk-like fibre likewise used for thread in Ao tradition, and is a small straight-growing shrub with leaves which the Nepalis eat as a vegetable, but which sting very severely, whence its Ao name of the “ iron nettle ”, *merang taklemtso*.

A different sort of plant also traditionally used for cloth is (8) a dwarf *Hibiscus* bearing flowers in July which change from pink to yellow. This plant is still occasionally used for making cords for carrying loads, and is known to the Aos as *mésukdamba*, “ the deer’s cotton-plant.”

Another plant, the use of which (for making thread and cloth) is traditional only, is (9) *Sterculia colorata*, a big forest tree bearing red flowers in August so prolifically that the Aos call it *methang*, "reverberation". It grows in forest land chiefly near water and at any height up to about 4,000 feet.

Yet another is (10) *Urena lobata* Linn., a branching shrub with pink flowers that give place to prolific burrs, so much so that the Ao name for the plant is *kūmenātsu*, "adhering to the hair".

So far all the plants said to be used for thread and cloth are only traditionally so, but further south we find the Āngāmi Nagas actually using three plants from which thread and cloth are still regularly made. It is perhaps worth noticing that the general culture of the Āngāmis is higher than that of the Aos, which suggests that the Aos have lost the use of their traditional fibres by a decline rather than an elevation of culture. Both tribes spin and weave in cloth, though the Āngāmi work is distinctly superior. The fibre plants still regularly used by the Āngāmis are *Pouzolzia viminea* Wedd., the fibre of which is used for making a coarse but very lasting cloth, and *Girardinia heterophylla*, the stinging nettle already mentioned (No. 7) with a large three-pointed leaf, and *Bahmeria platyphylla*, a "dead nettle" with a single-pointed leaf, both of which I have seen growing up to a height of about 7,000 feet. These two yield a finer thread than the first; it is mixed with cotton and woven into an excellent white cloth. The last-mentioned of the three, however, seems to be going out of use for some reason which I have been unable to find out definitely.

In addition to the foregoing, *Pueraria thomsoni* Bth., or perhaps *P. thunbergiana*, if not both, is used by Sēma and Lhōta Nagas to provide a fine cord for making heddle strings for looms. It is a creeper bearing bunches of deep purplish blue wisteria-like flowers in October. With the exception of this plant, the fibre plants which I have mentioned are given by Watt in *Economic Products of India*, but unfortunately he does not always say whether the quality of the plant mentioned is known to the inhabitants of the localities in which it is found, or who those inhabitants are. He does not always seem to give the locality, and in any case deals with India only.

The use of jungle fibres for cord, nets and ultimately cloth is perhaps in no way remarkable, and it is perhaps natural that with the introduction of cotton the use of fibres for cloth should disappear. The use of plants for dyeing, however, is a different matter, as the processes are some of them very complicated. In all cases the material to be dyed is boiled with the bark, wood, leaves or fruit, more often one of the two former, of the plant that yields the dye. In some cases this is enough to give a fast colour, in others the addition of a second plant as a mordant is necessary, in yet others a double process is required, the material having to be dyed a different colour first and then redyed to get the desired tint. The dyes used by the Āngāmi Nagas are not very numerous and some of them are well known. The plants that follow are all mentioned by Watt, though in the case of *Macaranga denticulata* and *Rhus semi-alata* he does not mention that they have any properties of value in dyeing. The Āngāmis cultivate *Strobilanthes flaccidifolius* Nees for the dark blue and black colour which it yields; red they obtain from *Rubia cordifolia* L. and from *R. sikkimensis* Kurz, yellow from *Berberis nepalensis* Spreng., all wild plants. As a deep red cannot be obtained from madder alone, the material is first dyed yellow with *Symplocos grandiflora* Wall. or *S. spicata* Roxb., and then redyed with one of the madders. A sort of drab fawn dye is obtained from *Cordia Myxa* L., the leaves giving a darker tint than the bark. As mordants *Macaranga denticulata* Müll Arg., *Morinda angustifolia* Roxb. and *Rhus semi-alata* Murr. are used, each with the dye to which it is suited; thus *Macaranga* is used with *R. cordifolia*, and *Morinda* or the berry of *Rhus* with *R. sikkimensis*. With *Strobilanthes*, *Berberis* and *Cordia Myxa* no mordant is necessary. To dye a fast lamp black the material is first boiled with *Macaranga denticulata* and then dried off, the remaining liquid being mixed with a black mud in which the material is again steeped. The iron salts in the mud act on the gallic acid in the *Macaranga* and produce a fast deep black.

Perhaps the most interesting point about these processes is the question of how they come to be known to these decidedly primitive tribes, whose communication with the outside world seems

to have been almost nil until quite recently, at any rate for a very long period of history indeed. If botanists could state for the benefit of anthropologists in what other parts of the world, in particular, parts other than Assam, India and Burma, the dyes and fibres used by Naga tribes are actually used or are known to tradition, the information would be of the greatest value in determining the affinities of Naga culture.

LINKAGE RELATIONS IN THE COTTON PLANT.*

BY

K. I. THADANI, M.Sc. (Texas), B.Ag., F.L.S., F.R.H.S.,
Cotton Breeder in Sind.

THE discovery that the development of certain characters in organisms is linked with that of certain other characters has been one of the most interesting results which have followed from the vigorous study of the problems of heredity in recent years. But so far little work in this direction has been done in the case of the cotton plant. And yet there is a very wide-spread belief among those who have grown the crop that such linkages occur in this case. It is, for instance, generally believed that a cotton seed which gives a high percentage of lint (ginning percentage) is not likely to be a cotton of long staple. This particular point is one which I have not yet been able to study, but I have to place several clear cases of similar linkages which I have observed in studies on American cotton.

SINGLE LINKAGE.

Case 1 (a). Linkage of seed fuzziness and amount of lint on the seed in cotton.

The factors involved are (A) which determines the naked condition of the seed-coat and its allelomorph (a) representing fuzzy seed ; (B) represents high amount of lint and (b) low amount. Both of these characters are easily distinguishable by the naked eye. The parents involved in the crosses are Naked low (Ab) and fuzzy High (aB). The F₁ hybrid is Naked High (AB) and in F₂ the segregation is in the ratio 2 Naked High (AB) : 1 Naked low (Ab) :

* Paper read at the Botanical Section, Indian Science Congress, 1923

1 fuzzy High (aB) : 0 fuzzy low (ab) as per data given in the following table.

TABLE I.

*F*₂ segregation of cross Naked low (Ab) × fuzzy High (aB).

Serial No.	Cross	NO. OF INDIVIDUALS				Total No.
		Naked High (AB)	Naked low (Ab)	fuzzy High (aB)	fuzzy low (ab)	
1	No lint × Lonestar ..	9	5	5	0	19
2	No lint × Texas rust ..	27	14	14	0	55
3	Acala × No lint ..	34	19	18	0	71
4	Acala × No lint ..	33	16	16	0	65
Observed totals		103	54	53	0	210
Ratio		2	1	1	0	
Calculated on independent segregation		118.1	39.4	39.4	13.1	210
Calculated on complete linkage ..		105	52.5	52.5	0	210

The calculated ratio based on independent segregation falls short of agreement with the observed totals; even though when each pair of characters is considered separately the agreement with the monohybrid ratio is very satisfactory. Thus for Naked and fuzzy characters the observed totals are 157 : 53 and for High and low amount of lint the observed totals are 156 : 54, which are a very close fit for a 3 : 1 ratio. Taking each pair separately, the factors evidently segregate in the normal Mendelian fashion; but the excess of the parental types and the corresponding reduction in the *F*₁ type and also the total absence of the fourth phenotype (fuzzy low) composed of both recessive members of these two pairs of characters in the *F*₂ generation indicate that the factor (A) representing Naked condition of the seed-coat and factor (b) representing low amount of lint, which both came from one parent, and their allelomorphs (a) and (B), which came from the other parent, do not get separated; and the observed totals are in agreement with the expectations on the basis of complete linkage. The factors, therefore, seem to

display complete linkage. Further evidence of this conclusion was obtained from the behaviour of the F_3 generation as shown in Table II.

TABLE II.

F_3 generation of the cross Naked low (Ab) \times fuzzy High (aB).

Phenotype	No. of F_3 individuals tested	Behaviour of progeny F_3	Genetic constitution
Naked High (AB) ..	103	All individuals heterozygous for both factors	A a B b
Naked low (Ab) ..	54	All individuals homozygous ..	A A b b
fuzzy High (aB) ..	53	Ditto	a a B B

The above table shows that F_1 type, that is to say, the Naked High (AB), can only exist in heterozygous condition and it is impossible to breed that type in homozygous state. Further, the parental types obtained in the F_2 generation refuse to split in the F_3 generation without exception, and breed true to type; which is quite contrary to simple Mendelian inheritance, in which case we must expect a certain proportion of the individuals proving to be heterozygous for the dominant factor. The results obtained justify the conclusion that the factors (A) and (b) and *vice versa* (a) and (B) are completely linked without any cross-over* which accounts for the absence of double-recessive (ab) fuzzy low type.

Case I b. A cross involving three pairs of factors two of which are linked.

One of the parents called "Texas Rust" has fuzzy seed represented by factor (a), high amount of lint (B), yellow cotton (C). Thus the phenotypic formula of this parent would be (aBC). The other parent called "No lint" has Naked seed (A), low amount of lint (b) and white cotton (c). Thus its phenotypic formula would be (Abc). In the cross aBC \times Abc the F_1 hybrid is ABC and F_2 segregation is given in Table III (Text-fig.).

* The possibility of a minute percentage of cross-over has still to be ascertained by growing a larger population.

When each pair of characters is considered separately, the agreement with monohybrid ratio is satisfactory; the observed totals for each of the three pairs of characters being 41 : 14. The ratio is a very close fit so that if only one individual were added to the dominant class it would be a perfect 3 : 1 ratio. But when two pairs of factors are considered in relation to one another, the following dihybrid ratios are obtained.

TABLE IV.

F₂ dihybrid ratios in the cross $Abc \times aBC$.

DIHYBRID COMBINATIONS		Phenotypes	Observed totals	Ratio
No.	Formula			
2	$Ab \times aB$	$AB : Ab : aB : ab$	27 : 14 : 14 : 0	2 : 1 : 1 : 0
3	$Ac \times aC$	$AC : Ac : aC : ac$	31 : 10 : 10 : 4	9 : 3 : 3 : 1
3	$bc \times BC$	$BC : Bc : bC : bc$	32 : 9 : 9 : 5	9.3 : 2.6 : 2.6 : 1.5

The above table shows that the factor for colour when considered in relation to the other two factors seems to display simple Mendelian inheritance, but the factors for seed fuzziness and amount of lint display complete linkage. This conclusion was confirmed by the study of the behaviour of the various phenotypes in the F_3 generation which has been described in Table V.

TABLE V.

F₃ generation of the cross $Abc \times aBC$.

Phenotype	No. of individuals tested	Formula	Behaviour	Genotypes represented in the group
Naked-High-Yellow	22	ABC	Some individuals heterozygous for A and B only ..	Aa Bb CC
Naked-High-white	5	ABc	others heterozygous for all ..	Aa Bb Cc
Naked-low-Yellow	9	AbC	All heterozygous for A and B ..	Aa Bb cc
Naked-low-white	5	Abc	Some heterozygous for C only ..	AA bb Cc
fuzzy-High-Yellow	10	aBC	others homozygous ..	AA bb CC
fuzzy-High-white	4	aBc	All homozygous ..	AA bb cc
			Some heterozygous for C only ..	aa BB Cc
			others homozygous ..	aa BB CC
			All homozygous ..	aa BB cc

Case 2. Linkage of vegetative colour with fruiting habit in cotton.

In a cross of "Red leaf" with several other American Upland cottons it is found that the red coloration of the plant is linked with cluster habit of fruiting as found in the "Red leaf" parent, and *vice versa* green colour of the plant is linked with non-cluster habit of fruiting as found in many of the Upland cottons.

The factors involved are (G) for red colour, (g) its allelomorph for green colour, (D) for Non-cluster fruiting and (d) its opposite for cluster fruiting. In the cross Gd × gD, the F₁ hybrid is GD and F₂ segregation is given in Table VI.

TABLE VI.

F₂ segregation Red cluster × green Non-cluster.

Cross	NO. OF INDIVIDUALS				TOTAL
	Red Non-cluster (GD)	Red cluster (Gd)	green Non-cluster (gD)	green cluster (gd)	
Durango × Red leaf	64	23	29	0	116
Acala × Red leaf	22	10	13	0	45
Ditto	30	10	18	0	58
Rowden × Red leaf	20	5	13	0	38
OBSERVED TOTALS	136	48	73	0	257

The investigations in these crosses have reached this stage only; F₃ generation when raised would provide further material for determining the mode of inheritance in this case. From the results obtained it is evident that this is another case of linkage between two factors in cotton. Although the ratios in several crosses are rather disturbed, still considering the first two crosses in Table VI, they come almost near the mark on the basis of complete linkage.

TRIPLE LINKAGE IN COTTON.

In the cross "No lint" × "Red leaf," there are four factors involved, and three systems of linkage are found in one and the same cross. This cross is represented by the formula AbgD × aBGd. The F₁ hybrid is ABGD and the F₂ segregation is shown in Table VII.

TABLE VII.

*F*₂ segregation *AbgD* × *aBGd* cotton cross involving three systems of linkage.

Phenotype	Formula	No. of individuals
Naked-High-Red-Non-cluster	ABGD	16.
" " " -cluster	ABGd	5
" " -green-Non-cluster	ABgD	15
" " " -cluster	ABgd	0
Naked-low -Red-Non-cluster	AbGD	6
" " " -cluster	AbGd	3
" " -green-Non-cluster	AbgD	10
" " " -cluster	Abgd	0
fuzzy-High -Red-Non-cluster	aBGD	14
" " " -cluster	aBGd	3
" " -green-Non-cluster	aBgD	5
" " " -cluster	aBgd	0
fuzzy-low -Red-Non-cluster	abGD	0
" " " -cluster	abGd	0
" " -green-Non-cluster	abgD	0
" " " -cluster	abgd	0
TOTAL	77

The *F*₂ segregation here displayed is not in accordance with the expectations based on independent distribution of the four pairs of factors involved in this cross, since only nine phenotypes have appeared. Evidently it is a case of linkage. In order to get an idea as to which factors are linked in this cross, we should examine dihybrid ratios as given in Table VIII which has been compiled from Table VII.

TABLE VIII.

*F*₂ dihybrid ratios obtained in cross *AbgD* × *aBGd*.

DIHYBRID COMBINATIONS		Phenotypes	Observed totals
No.	Formula		
1	Ab × aB	AB : Ab : aB : ab	50 : 19 : 22 : 0
2	gD × Gd	GD : Gd : gD : gd	36 : 11 : 30 : 0
3	bg × BG	BG : Bg : bG : bg	38 : 20 : 9 : 10
4	bD × Bd	BD : Bd : bD : bd	50 : 8 : 16 : 3
5	Ag × aG	AG : Ag : aG : ag	30 : 25 : 17 : 5
6	AD × ad	AD : Ad : aD : ad	47 : 8 : 19 : 3

The above table shows that, of the six possible dihybrid combinations in this cross, the last three seem to follow independent Mendelian inheritance although the ratio of 9:3:3:1 is greatly disturbed; the first three are apparently cases of linkage.

CONCLUSION.

In conclusion, it will be seen that there is evidence of the linkage of certain of the seed characters in American cotton. And this fact may be of great importance in breeding types of cotton of commercial value. In certain cases it will be impossible to combine characters, which may be desirable, and this should always be borne in mind by those who are studying the crop. In case two pairs of factors are completely linked, it will not be possible to obtain any combination other than the parental type. If partial linkage occurs, a much larger number of plants will have to be grown in the segregating generations than would otherwise be necessary in order to obtain the combination desired.

POLLINATION METHODS AMONGST THE LESSER MILLETS.*

BY

W. YOUNGMAN, B.Sc.,

Economic Botanist to Government, Central Provinces ;

AND

S. C. ROY, L.Ag.,

Assistant Economic Botanist, Central Provinces.

THERE is a collection of food grain plants known as the lesser millets, called lesser because they are smaller in habit than the *juars* (*Andropogon Sorghum*) and *bajras* (*Pennisetum typhoideum*) which are the greater millets. They yield a small coarse grain and are only grown by the very poorest of the population in the poorest of soil which will grow practically nothing else; a hill slope that holds no water often being where they are grown. These lesser millets are all included in Hooker's *Panicææ* which also includes the greater millet *bajra*. The *Panicææ* are a very diverse group, and the various genera Hooker includes under this head do not appear in all cases to show close natural relationship. In one character the lesser millets, however, show considerable uniformity. They are mostly self-pollinated. The way in which this is attained is interesting in different cases. Self-pollination is as common amongst the lesser millets as it is rare amongst the greater.

Panicum miliare seems in nature to be almost entirely selfed in spite of numerous neighbours and what appears abundance of opportunity for cross-pollination. We experienced no difficulty in crossing it artificially, but we found the process of emasculation to be a very delicate operation. The difficulty is that the flower

* Paper read at the Botanical Section, Indian Science Congress, 1923.

rarely stands the treatment necessary to open the glumes in bud condition for the operation. In spite of this difficulty we did succeed in a few cases. Another method we employed for effecting cross-pollination more readily is the following, but very great care is required to avoid selfing. In this we allowed the glumes to open of their own accord and at once removed the anthers with fine forceps. Any spilled pollen grains we removed from the stigmas or other parts of the flower by a delicate spray of water from the fine jet of an ordinary chemical wash bottle.

In nature, crossing is prevented almost entirely by the short duration of time occupied in the blooming of the flower and also by the comparatively small number of flowers opening on a plant at the same time, so that any individual is not immediately surrounded by an enormous number of blooming neighbours. The time between the opening and closing of the flower we found to be from 15 to 20 minutes only. At Nagpur, the flowers open between 9-30 A.M. and 10-30 A.M., the actual time depending upon atmospheric conditions. The glumes open and gape apart, this being brought about by the expansion of the two lodicules at the base of the ovary which push the pales apart. The styles and anthers are packed inside the upper pale in a peculiar way. In a young flower the styles stand up like a pair of horns from the top of the ovary, with a slight bowing or curvature near their bases, the convex side being outwards (Fig. 1).



FIG. 1



FIG. 2.



FIG. 3.

Stigmas protruding from the flower.

Panicum miliare; upper pale and stigmas only.

Later the styles elongate and the stigmas are arrested by the incurved edges of the apex of the pale. This causes the two actively growing styles to cross over each other twice, once at the top of the

original bowing and again just below the stigmas (Fig. 2). At the same time the anther stalks increase in length to such an extent that a kink appears in them (Fig. 5). The filament, as its length



FIG. 4.

Young stage; one anther taken out. Other two are behind the styles.

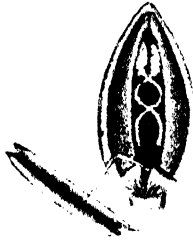

FIG. 5.

Older stage showing increase in length of filament and its kink.

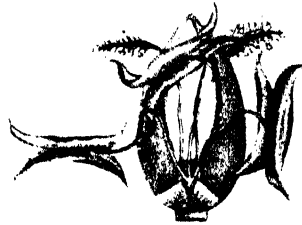

FIG. 6.

Stage after opening of flower.

Panicum miliare; lower pale removed.

increases thus, becomes folded, but always remains elastic like a spring bent upon itself. The tension reaches such a pitch that on the commencement of the opening of the glumes, the styles and filaments, at once, with explosive suddenness, spring out. The flowers that are ready to bloom can be made to do so immediately by just drawing the inflorescence through one's closed hand, the slight pressure starting the springs to work, as it were. Soon after this, the anthers begin to burst, one after another, while still encircling the two stigmas. This bursting takes place by sudden spasmodic jerks and the pollen grains are thrown out with great force in all directions. As a result of this, the stigmas almost invariably get pollinated at a period within two minutes from the commencement of the opening of the glumes. The anthers, soon after bursting, shift their positions and in so doing rub against the stigmas and then fall out of the flower, assuming the pendant position. The glumes remain open for about 15 to 20 minutes and then close again, the stigmas generally remaining out on either side, rarely going back with the closing of the glumes. The crop, therefore, as a rule, is self-pollinated. The chances of cross-pollination come in only when the glumes have just opened,

and the blowing in of some foreign pollen on to the stigmas, before the bursting of the anthers, might effect it but it is rare.

In the case of *sawan* (*Panicum crus-galli*, var. *frumentaceum*), another of the lesser millets, which is also often used as a food crop, the pollination is slightly different. The flowers open much earlier, between 7-30 and 8-30 in the morning. The glumes open more slowly than in *Panicum miliare* and the stigmas and the anthers come out simultaneously through the opening of the glumes. The stigmas spread out immediately on either side, while the anthers hang about them without dehiscing for about 1 to 1½ minutes and then burst in the same jerky fashion as in *Panicum miliare*, throwing the pollen all around. They never assume the pendant position as in *Panicum miliare* but remain close to the stigmas until the flowers close back again after remaining open for about half an hour.

In *kodon* (*Paspalum scrobiculatum*), only about 5 per cent. of the flowers have been found to open at Nagpur, the rest are all cleistogamous, always remaining closed. The flowers that open, do so between 7-30 and 8 o'clock in the morning and remain open for about 20 to 30 minutes. Soon after the opening of the glumes, the anthers burst and the stigmas spread out on either side. Self-pollination takes place immediately and then the glumes close back. The cleistogamous flowers are so numerous in comparison with the others that it is rarely that one meets with an open flower in a morning.

A result of the almost general self-pollination amongst the smaller millets, as indicated above, is the remarkable uniformity of the crop. A field study of these crops reveals but few varieties. The greater millets, in which crossing is considerable, on the other hand, show many varieties. The varietal characters amongst the smaller millets are often such insignificant ones as stigma colour, variation in the size of grain, and branching habit.

FURNACES FOR THE MANUFACTURE OF GUR.

BY

H. R. STEWART, A.R.C.Sc.I., D.I.C., N.D.A.,
Professor of Agriculture, Punjab Agricultural College, Lyallpur ;

AND

SARDAR SAHIB KHARAK SINGH, M.A.,
Associate Professor of Agriculture, Punjab Agricultural College, Lyallpur.

As a sugarcane producing province, the Punjab ranks second in importance in India. The area annually under this crop varies between $4\frac{1}{2}$ and 5 lakhs of acres. This represents some 18 per cent. of the total area under sugarcane in British India. It is generally considered to be one of the best paying crops which the average cultivator grows, and with him its area is limited mainly by the lack of sufficient irrigation water for a larger area. This at least holds good for canal and well irrigated lands. So far as its water requirements are concerned, it makes greater demands than any other crop, requiring during its growth some 12 to 15 irrigations (in a district where the annual rainfall is 13 inches) as against four for wheat and five or six for cotton.

In the canal colonies of the Punjab, the average cultivator puts one acre per square, or about 4 per cent. of his land, under sugarcane. From this area he eventually gets about 30 maunds (1 maund = 82 lb.) of *gur* (crude, unrefined sugar) which is the form in which he usually disposes of this crop. This quantity is the produce after evaporation of about 170 maunds of juice. The trials later described show that to evaporate 100 maunds of juice he ordinarily requires from 70 to 80 maunds of fuel. Hence, for the juice from one acre of cane fuel to the extent of some 120 to 130 maunds is required. Recently in experiments conducted at Lyallpur with better varieties of cane which contain a higher percentage of juice,

yields of 80 to 90 maunds of *gur* are being obtained. These varieties are just beginning to be taken up by the zemindar. The fuel which he will require will thus be proportionately greater than he at present needs with his local canes. These higher yielding canes cannot, indeed, produce sufficient fuel for the evaporation of their own juice.

One of the greatest problems in most parts of the province is the supply of fuel. Failing anything else, the zemindar always falls back on that most destructive and uneconomic of all sources, viz., his farmyard manure. Unfortunately most of this is still consumed as fuel instead of being returned annually to the land from which it comes. In the case of the fuel necessary for *gur* making, the cane crop itself provides most of what is required in the form of leaves and the megasse obtained after extracting the juice. With the ordinary country method of *gur* making all this is required for the evaporation of the juice, and in some cases other materials such as cotton sticks have also to be used.

The destruction as fuel of the large mass of foliage provided by the crop is highly uneconomic, as these leaves contain a large part of the plant food which the crop has removed from the soil. They are valuable as a manure, and if furnaces can be introduced which will reduce the amount of fuel required for the evaporation of the juice, the leaves that can be spared are at once rendered available as manure. Fuel and manure are very closely correlated in this country, and in the present case the cane foliage is released either to be used as litter for the farm stock, and so find its way eventually to the manure heap, or to be ploughed in directly to the land. Any saving in fuel of this nature, therefore, which can be effected releases a similar amount of material for manure. These leaves are especially good not only on account of the food material they contain but for the humus which they add to the soil, thereby increasing its water holding capacity—a point of very practical importance here.

In the improvement of furnaces the saving of time is another point to be aimed at. Normally the zemindar is dependent entirely on the sun to dry his megasse and make it fit for burning, and when

the elements fail him, as they often did here during the past season owing to dull weather and occasional rain, he has no alternative but cease work till the sun shines again. This runs his harvesting very late in the season, and he is still crushing cane when he should be preparing to sow cotton, or harvesting his *rabi* crops. A furnace, therefore, which will be more economical in time as well as in fuel is what is aimed at.

The investigations made here this year on the improvement of *gur* furnaces were originally necessitated through the purchase of a large power driven cane crusher. The small country furnace in use was not sufficient to deal with the quantity of juice produced. After some trials with a large furnace of the McGlashan type, in which its efficiency was compared with the local furnace, we then passed on to the investigation of smaller types more suited to the small growers of this district. In all cases, whether with large or small furnaces, the object aimed at was to produce a furnace which would save both fuel and time and whose installation would entail a minimum expense to the zemindar.

The following are the various furnaces tried :—

I. THE LOCAL FURNACE.

This consists of a large circular pit six feet deep with slightly curved sides. The feeding mouth is a circular hole 12 inches in diameter situated some 6 inches below the top of the furnace. The exit for the smoke and hot air is placed opposite the feeding mouth and is a circular hole 10 inches in diameter. After passing through a flue the smoke emerges from a chimney 6 to 7 feet high. The top of the furnace is a circular opening about 2 feet 10 inches in diameter on which an iron pan, with curved bottom and sides, is placed. This pan can hold from 1½ to 2 maunds of juice at one time.

This furnace is the one in most common use all over the province, and is the most primitive and the most inefficient of all the furnaces tried. It suffers from three great defects :—

- (a) The fuel as it is fed falls in a heap on the bottom of the furnace, part of it becoming buried in the ashes.

The supply of air is limited and very imperfect combustion is obtained. This is clearly shown by the large amount of ash remaining behind and by the fact that one often finds the furnace still smouldering for days after work has ceased.

- (b) The pit is very deep, and the flame is too far from the bottom of the pan.
- (c) The flame is directed towards the hole for the exit of smoke and so does not give the maximum heat to the pan. Much of the heat is, in fact, lost for this reason.

A scale diagram of this furnace is given in Fig. 1 and the figures showing time taken and fuel consumed are given in Table I.

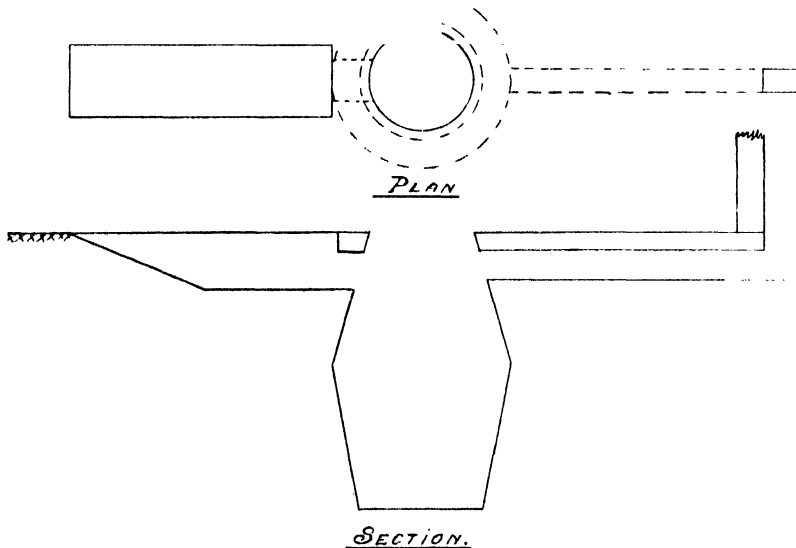

FIG. 1.

(All figures are on the scale of $\frac{1}{8}$ inch 1 foot.)

From the latter it is seen that the time taken to evaporate one maund of juice is 46.4 minutes and the fuel necessary for this is 70 per cent. of the weight of the juice.

TABLE I.
Country furnace.

Juice evaporated		Fuel consumed		Time taken		Time taken to evaporate 1 maund of juice	Fuel used per 100 maunds of juice
Mds.	Srs.	Mds.	Srs.	Hrs.	Mins.	Mins.	Mds.
3	6	2	20	2	38	50	79.3
1	23	1	2	1	15	48	66.6
4	29	3	30	3	21	42	78.9
4	25	3	27	4	30	58	79.6
9	27	6	11	6	2	38	64.8
15	30	10	16	11	0	42	66.0
				AVERAGE		46.4	70.0

II. THE MCGLASHAN FURNACE.

This furnace is described in the *Agricultural Journal of India* (Vol. XV, 1920, p. 520) and *Bulletin No. VIII of the Department of Agriculture, Central Provinces*. It was set up at Lyallpur in its

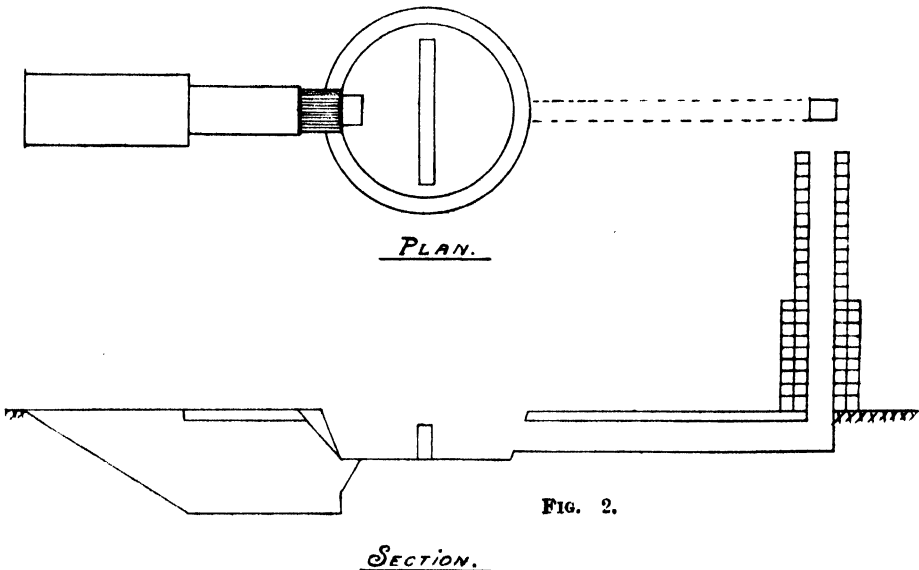

FIG. 2.

original size and according to the dimensions given in the Bulletin above quoted. From the figures given in Table II it will be seen that in comparison with the old country one it is a most efficient furnace. The average time taken to evaporate one maund of juice was 18.9 minutes and the fuel consumed is 33 per cent. of the weight of juice. This represents less than one-half the fuel and considerably less than half the time required for the country furnace.

TABLE II.

McGlashan 7-foot furnace.

Juice evaporated		Fuel consumed		Time taken		Time taken to evaporate 1 maund of juice	Fuel used per 100 maunds of juice
Mds.	Srs.	Mds.	Srs.	Hrs.	Mins.	Mins.	Mds.
6	23	2	23	1	55	17	34.1
6	33	2	3	2	0	18	30.4
6	33	2	10	2	0	18	32.9
6	33	2	15	2	20	20	34.8
6	37	2	19	2	8	18	35.7
11	22	4	0	3	0	16	34.6
8	16	2	30	2	15	16	32.7
8	16	2	32	2	30	18	33.3
29	16	9	25	32.7
10	32	3	30	4	35	25	33.6
5	16	1	24	29.7
16	8	4	29	5	25	20	29.2
AVERAGE ..						18.9	33.0

This is the most efficient furnace of those so far tried. It is a very good furnace for the zemindar who grows a large area of cane and will save him much in time and fuel. Two such furnaces can deal with the juice from a power driven cane mill crushing 14 maunds of cane per hour, or one furnace can evaporate that produced by two of the bullock driven iron mills in common use in most districts in this province. For the average cultivator here, however, something smaller would be more practical, as his area under sugarcane is generally not more than three acres.

It is noticed here that when canes are crushed with a power machine the megasse is broken into small pieces which are inclined to fall through the grating during feeding to the furnace if the grating is made to the specification given in the Bulletin quoted. This was remedied here by using $\frac{1}{4}$ inch bars instead of $\frac{1}{2}$ inch bars and placed $\frac{1}{8}$ inch apart instead of $\frac{1}{4}$ inch. This was a decided improvement and all the gratings afterwards used were of these dimensions.

III. MODIFIED MCGLASHAN FURNACE WITH $4\frac{1}{2}$ FEET PAN.

In order to provide the small cultivator with a furnace more suited in-size to his requirements than the 7-foot McGlashan and at

the same time give him the advantages of the improvements therein obtained, a furnace was constructed of the McGlashan type but reduced to accommodate a 4½-foot pan. It soon became apparent that this furnace was not completely successful. Its main defects were that the juice boiled only near the feeding mouth and not equally all over, that the heat near the mouth was so great that the juice became burnt and that the consumption of fuel was not very much less than with the country furnace. These faults were remedied after further investigation in two ways : (1) by setting the brick and mud wall which was in the centre of the furnace floor farther back nearer the smoke exit, and (2) by reducing the exit flue from 15 inches \times 7 inches to 9 inches \times 7 inches. Whereas in the full scale McGlashan the distance from the grating to the centre wall was 3 feet 3 inches, in the reduced size it was only 2 feet. The flame had therefore a very short distance to travel till it was deflected upwards to the pan and accordingly was so strong that the juice was burnt. Further, the back flue was so close to the feeding mouth (only 4 feet) that much of the heat passed directly out without aiding in evaporating the juice. The lay-out of this furnace is given in Fig. 3 and the results obtained in Table III. They show that the fuel consumed is higher than

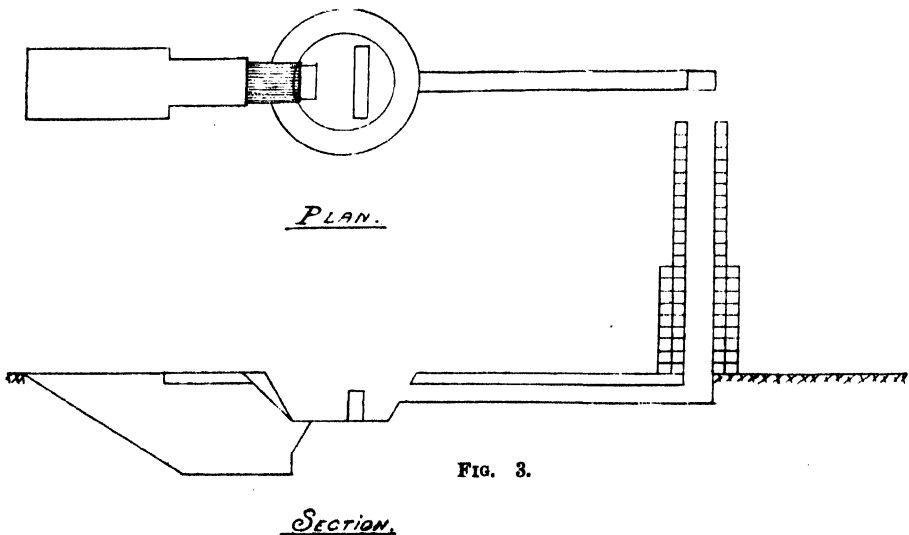

FIG. 3.

in the full size McGlashan but is only two-thirds of that of the country furnace. The time saved is over 20 per cent.

TABLE III.

Improved McGlashan 4½-feet furnace.

Juice evaporated		Fuel consumed		Time taken		Time taken to evaporate 1 maund of juice	Fuel used per 100 maunds of juice
Mds.	Srs.	Mds.	Srs.	Hrs.	Mins.	Mins.	Mds.
7	35	3	25	5	0	38	46
7	35	3	24	4	30	34	45
8	16	3	37	5	0	36	46
10	20	4	33	6	0	34	45
5	10	2	12	2	45	32	42
8	37	3	30	3	30	24	41
7	35	3	25	5	0	38	46
7	22	3	16	4	7	33	45
7	35	3	24	4	58	38	46
5	31	2	24	3	43	38	45
5	10	2	12	3	55	45	44
AVERAGE ..						35.5	45.6

IV. MULTIPLE FURNACE.

In this experiment an attempt is made to make use of the waste heat which passes out through the flue of the reduced McGlashan by causing it to pass under a second pan and so evaporate a further quantity of juice. Fig. 4 shows the

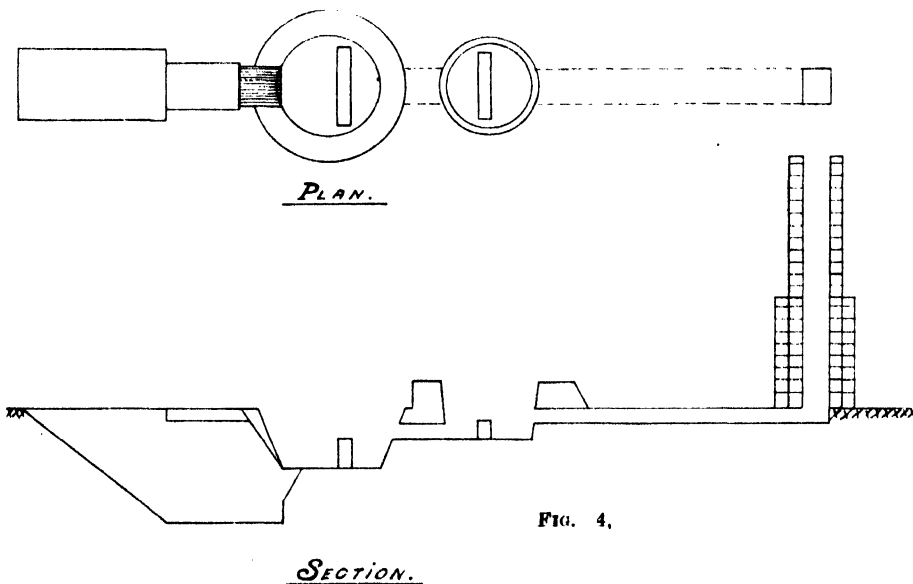

FIG. 4.

arrangement of this furnace. The first part is exactly as described for the reduced McGlashan. The second pan is placed at a level 15 inches higher than that of the first pan. Whereas the latter is $4\frac{1}{2}$ feet in diameter, the second is 3 feet and the furnace for it is 2 feet 7 inches in diameter at the top. About 2 to $2\frac{1}{2}$ maunds of juice are put in the first pan and about half a maund in the second. Whilst the juice in the first has become partially evaporated, that in the second has become hot and somewhat less in volume. Later the juice from the second is run into the first where evaporation is completed, fresh juice being added to the second. The results obtained appear in Table IV and show a very great saving in fuel over the country furnace. In point of economy of fuel this furnace comes next to the full size McGlashan, using only 40 per cent. of the weight of juice evaporated. The reduction in time though considerable is not yet what it should be and falls far short of the large furnace.

TABLE IV.

Multiple furnace, improved McGlashan type.

Juice evaporated		Fuel consumed		Time taken		Time taken to evaporate 1 maund of juice	Fuel used per 100 maunds of juice
Mds.	Srs.	Mds.	Srs.	Hrs.	Mins.	Mins.	Mds.
5	29	2	22	3	45	40	44
3	38	1	26	2	24	37	40
5	10	2	6	2	45	31	41
8	37	4	17	5	20	36	49
12	3	5	12	6	55	34	44
9	18	3	26	39
7	0	2	28	5	0	43	39
15	30	6	15	41
9	18	3	32	5	25	35	40
9	18	3	35	5	30	35	39
15	30	6	20	41
13	30	4	30	35
6	12	2	12	4	20	41	36
18	36	6	30	36
				AVERAGE ..		36.4	40

V. THE IMPROVED LOCAL FURNACE.

In this an attempt has been made to improve the ordinary country furnace so that the zemindar could still use his ordinary curved bottomed pan. In all the other experiments described the pans used have all had flat bottoms. All the important points of the other furnaces were embodied in this furnace, viz., grating, flue, bottom wall, etc. In this case it was found that two walls on the floor of the furnace were better than one. The great depth of the country furnace was also reduced. Fig. 5 shows the arrangement of this furnace.

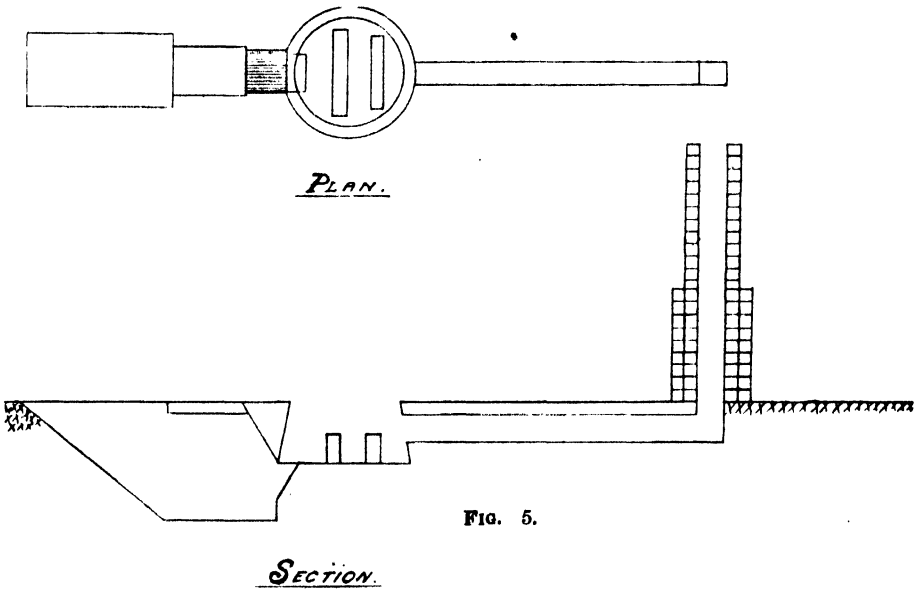

FIG. 5.

From Table V it will be seen that there is a saving of about 25 per cent. in the fuel consumption as compared with the old country furnace but no saving in time so far as the experiment has at present been carried.

No tests were made with the idea of comparing flat and round bottomed pans, but it would appear that the flat pan is much the more efficient. It is recommended, therefore, that, as soon as the old round bottomed pans become unserviceable, flat pans could be

TABLE V.

Improved country furnace.

Juice evaporated		Fuel consumed		Time taken		Time taken to evaporate 1 maund of juice	Fuel used per 100 maunds of juice
Mds.	Srs.	Mds.	Srs.	Hrs.	Mins.	Mins.	Mds.
3	6	1	35	3	0	58	59
5	20	2	32	5	0	55	50
6	12	3	20	5	0	48	55
2	25	1	12	1	5	25	49
6	12	3	20	5	10	49	55
6	12	3	19	4	36	44	55
8	2	4	7	6	36	49	52
6	4	3	30	5	50	57	61
4	3	2	16	3	45	55	59
3	22	1	37	3	35	61	54
8	16	3	34	8	12	58	46
23	4	11	20	18	30	48	50
				AVERAGE ..		50.5	52.7

substituted with no additional cost and with the gain of much fuel. Meantime, whilst these pans continue to be used, the zemindar can effect some saving in fuel by altering the type of his furnace at little or no cost. The grating costs about Rs. 2, and the whole of the work he can do himself with very slight cost.

Where a cultivator has up to eight acres of sugarcane, he usually has one bullock driven crusher and two country furnaces. The work of these two furnaces can easily be done by one multiple furnace of the type described above. He can thus save a very large amount of fuel and, in addition, less labour will be required. For ten acres of cane two bullock crushers or a power driven machine are required. For dealing with the juice from these, three country furnaces are required. These can be replaced by one furnace of the full size McGlashan type, resulting in the saving of an enormous amount of fuel as well as of time and labour. The cost of erecting a McGlashan furnace is less than that of three country ones. The 7-foot pan weighs about $4\frac{1}{2}$ maunds and costs about Rs. 90, while three country pans amount to about the same. The cost of making the furnace itself is not more than Rs. 5.

The following are the comparative figures for the various furnaces tried :—

Type of furnace	Average time required to evaporate 1 maund of juice	Average fuel required to evaporate 100 maunds of juice
	Mins.	Mds.
Country furnace	46.4	70.0
McGlashan, 7 feet	18.9	33.0
Improved McGlashan, 4½ feet	35.5	45.6
Multiple furnace	36.4	40.0
Improved country furnace	50.5	52.7

It is thus seen that all the types tried above are better than the local furnace. Of them all, the full-sized McGlashan is the best and is suitable for large cultivators or for small zemindars also if two or three co-operate together and use their bullock driven cane crushing machines jointly for such a furnace. Should he not wish to discard his round bottomed pan, the zemindar can at a trifling cost alter his furnace and save much fuel, until such time as he requires a new pan when he should purchase a flat bottomed one. The saving effected will then be much greater as the megasse is practically sufficient to evaporate the juice, rendering almost the whole of the trash and leaves available as manure.

The practical work embodied herein has been carried out entirely by the second author with suggestions from the first named who is responsible for its presentation.

THE MESQUITE (*PROSOPIS JULIFLORA*).

BY

W. ROBERTSON BROWN,

Agricultural Officer, N. W. Frontier Province.

IN the March (1923) Number of the Journal (XVIII, Pt. 2), Dr. K. Kunhikannan brought this useful sub-tree to the notice of the Indian farmer. My first acquaintance with it was in 1905 at Lahore, where its remarkable resistance to drought was already fully appreciated by the Superintendent of the Agri-horticultural Gardens, and it was being successfully employed to clothe red sun-baked brick-kiln mounds in the gardens and around the city. Since then I have seen the mesquite at many places between Cawnpore and the Khyber, also in South Africa, and no matter how hot the position, the tree has invariably been vigorous and bountiful of fruit. At the Peshawar Agricultural Station, where the mercury frequently exceeds 120° F. in the burning summer days, and falls to 26° F. in the cold season, where the average annual rainfall is about 13 inches only, a trial was started in 1911 to determine the economic value of the tree, as food for stock, for fuel, and in clothing dry waste land. With no attention whatever since the plants were set out, the mesquite has flourished exceedingly and borne heavy crops of beans (Plates XXI and XXII, fig. 1). The results of the observations at the station may be briefly stated as follows:—

Food for stock. Well-fed sheep and goats readily eat the ripe beans under the trees, but take them sparingly from the crib. Cattle or horses in good condition do not eat the beans. Neither sheep, goats, cattle, horses, nor even camels willingly eat the mesquite leaves.

Fuel. No tree grows more rapidly than the mesquite on arid land, or yields more fuel thereon in a shorter space of time. The wood burns well.



ARID DUSTY ROAD CLOTHED WITH MESQUITES.
(Hundreds of camels, goats, sheep and cattle pass along this road daily.)

Fig. 2. Mesquite seedlings:
(1) three months old; (2) one
month old.

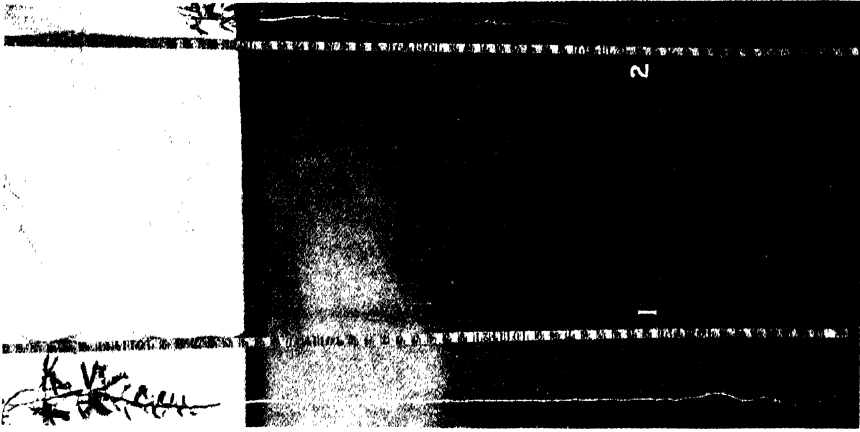

Fig. 1. A spray of mesquite beans.



Clothing arid land. To convert bare, drought-stricken yet fertile land in the N. W. F. Province into open wood-land, it is only necessary to establish a few groups of mesquite trees on the tract, and to leave the work of seed distribution to the sheep and goats which eat the beans but not the plants. To clothe dry sun-stricken ravine land, or to embellish slopes or banks, no shrub or plant of any kind known to me can compare with the mesquite in persistent vigour and delicate beauty. From the beginning of April, when the pendulous sprays of graceful feathery foliage and honey-coloured tassels of blossom unfold, until late November when, for the second time in the year, the branches of the trees bend with their load of nourishing beans, few of the great family of Acacias are more pleasing than the mesquite. By the roadsides in desert tracts, where the *kikar* (*Acacia arabica*), the *ber* (*Zizyphus jujuba*), the *phulai* (*Acacia modesta*), and even the *jhand* (*Prosopis spicigera*) do not survive, the mesquite can be established in belts or plantations (Plate XXI). In the past few years, officers who have been studying at the Peshawar station with a view to farming abroad, have been impressed by the beauty and usefulness of the mesquite, and numerous parcels of seed have been sent to them in Africa and Australia.

When on an agricultural tour in South Africa in 1921, I was invited to visit some farms on the Karroo—that vast dry tract of heathery scrub whereon, in the frequent visitations of drought, hundreds of thousands of the Merino lambs have to be sacrificed at birth to save the famished ewes from death—and to think of any drought-resistant shrub or tree which might help to tide over the periods of pasture famine. As the homestead of the first Karroo farm was approached, almost the first trees to come in my view were mesquites. An eager inquiry revealed the fact that the trees had been planted by an officer of the Indian Irrigation Service who had been engaged in the construction of a dam near the farm, and had procured the seeds from the Punjab. I was informed that the sheep ate the beans greedily, and that by their agency seedlings were springing up far over the land. The farm manager only feared that the mesquite might become too aggressive. I determined

to find by actual experiment in India the extent to which seedling mesquites might be expected to germinate from the dung of sheep not specially fed on mesquite beans, but which had picked up the beans in the course of their daily wandering over stubble, on pasture, or under the mesquite trees. On 6th September, 1921, 10 seed-beds, each measuring 8 square yards, were sown with the dung of the Peshawar station sheep which have access to mesquite trees. The dung was over six months old, and it is noteworthy that it had not been consolidated. It is the practice at the Peshawar station to sweep the pens and remove the droppings almost daily. The beds were irrigated and within five days fully 300 mesquite seedlings sprang up in each small bed. When the plants were 4 inches high and less than a month old, the roots of some of them were found to be over 4 feet long (Plate XXII, fig. 2). To gain information on a field scale, a border, half a mile long and 12 feet wide, was next manured with the sheep dung. Seven days after irrigation was given—within seven days of spreading the dung—thousands of seedlings germinated throughout the length of the border. The results of these tests were published in the *South African Journal of Agriculture* (January 1923). Clearly then, sheep eat mesquite beans and the voided seeds germinate readily when the land is moist. To establish the mesquite on any dry tract or ravine land between Cawnpore and Peshawar, it is only necessary to sow small nucleus areas here and there, after rain has fallen in the month of August or September, or perhaps even in the early spring, and to let the plants fight their way to fruitfulness, after which the sheep and goats may be depended on to clothe the land with this valuable famine fodder. Although the germination of the seeds is most surely attained by feeding the beans to sheep, excellent results may also be got by pouring boiling water over the seeds in the evening and letting them steep till they are sown on the following day. Beans or seeds of the mesquite can probably be supplied by the Government gardens in North-West India. The crop at Peshawar is being employed in sowing bare ravine land in the province.

THE CULTIVATION OF POTATO IN ITALY.*

BY

G. S. KULKARNI, M.AG.,

Offg. Plant Pathologist to Government, Bombay.

AMONGST the important potato growing countries of Europe, Italy occupies the seventh place with 300,000 hectares (1 hectare = 2.47 acres) devoted to the crop, against 2,647,161 in Germany which stands first, 1,453,310 in France which stands third and 517,873 in Great Britain and Ireland which stands fifth.¹ Though it stands so low in acreage, Italy has certain natural advantages over other countries. As it is situated far enough south to secure the benefit of brilliant sunshine and comparative freedom from spring frost, the potato harvest begins much earlier. The early crop begins to ripen from May, the main crop is ready from July onwards and the hill crops are lifted in September-October. As most of her crop is dug before the general harvest of Europe begins, Italy retains to a certain extent the monopoly of supplying, in the earlier part of season, the markets of Austria, Hungary and Germany and at times those of France, England and Belgium. Her main crop, however, is exported to Constantinople, Smyrna, Egypt, Aden, Bombay and Colombo.

As the potato cultivation in the Bombay Deccan and to some extent in Madras and Mysore is dependent on the importation of Italian seed tubers, and as no information, as to how these seed tubers are grown in Italy, was available, the writer spent a short period of his deputation in the month of August 1922 to study this

* This paper, based on observations made by the writer while on deputation to Europe to study the potato crop and its diseases, was read at the Indian Science Congress, 1923.

¹ *Inter. Yearbook of Agri. Statistics, 1909-1921.*

industry in Italy. A short description of the potato cultivation in Italy¹ should, therefore, be of interest.

Excluding the driest tracts, the potato is cultivated everywhere in Italy. The districts that interest India most, however, are Naples, Caserta, Salerno, Avellino, Benevento, Campobasso and Aquila. All the places except the last two are near Naples comprising the province of Campania. Campobasso is on the border of Campania, while Aquila is situated north-east of Rome in the Appenine Hills.

The province Campania, meaning "The Plain," has a densely crowded population and intensive cultivation. It is one of the most prosperous and fertile tracts, enriched by the ashes of Vesuvius, and has therefore become a great seat of Italian commerce centring in the seaport Naples.

A great peculiarity of this tract is the growth of vines round elm trees planted in rows between which other crops are grown. The potato, therefore, forms one of the secondary crops in the grape gardens. This mode of cultivation naturally demands a very rich soil and is practised also in the basin of the river Po and in Sicily. The soil is very fertile and easy to work, as it is a deep good loam. The climate is quite suited to the crop. The mean temperature is 60° F., and the average rainfall is 32 inches and is well distributed. Therefore no irrigation is practised. It is only in the immediate vicinity of the towns where cultivation is very intensive that irrigation is sometimes resorted to whenever the rains fail. Water is raised from shallow wells of 5 to 10 feet deep by the lift *noria* worked by a single animal, either a mule, ass or horse. At some places a *pikota*-like handlift is used.

The crop is grown in small plots. The average size of holdings is five to ten acres, though fields of fifteen acres and upwards are not uncommon. Usually half the area of the holding is under potato. The cultivator rents the land from the landowner.

¹ The writer begs to acknowledge his indebtedness to the officers of the British Embassy at Rome, to those of the Italian Department of Agriculture, to those of the International Institute of Agriculture, Rome, and to Mr. Little, a potato merchant at Naples, for the help rendered by them in getting information on the subject.

The cultivation is carried on by hand labour with an implement called Zapa. In the months of August and September the land is dug with the Zapa, and the green manuring crop, either lupin, bean or turnip, sometimes all the three mixed together, is broadcasted. It is buried, for the early crop, in December, and for the late one in January or February. Soon after this operation the potato crop is planted. The sets are put at forty centimetres apart in furrows of sixty centimetres distance. The seed rate per acre is about eight quintals (1,760 lb.).* After germination, when the shoots are two inches high, the crop is top-dressed with either sulphate of ammonia or superphosphate (150 lb. per acre). When the plants attain a height of about six inches, that is to say, in the month of April, they are earthed up and sprayed with Bordeaux mixture as a preventive against blight (*Phytophthora*). The crop then requires little attention during its growth period. An occasional hand-weeding or a second spraying, if the weather conditions get moist, are the only operations. The early crop is ready in May and the late one matures from July onwards. The crop is harvested by hand-digging and the tubers are sorted into three grades: big, medium and small. The big ones are for immediate sale, the mediums are reserved for seed and the small ones are used for pig-feeding. The average yield per acre is 50-60 quintals. In good fields it rises from 80 to 100 quintals, and in the best fields even 120 quintals have been recorded.

The seed tubers are stored in sheds called Peglia situated near the farm-houses. They are usually made of lupin straw and are ten feet long, six feet wide and eight feet high. The tubers are at times stored in pits called Fossi dug in the fields. The pit is lined with straw before the tubers are put in. The upper part of the heap is also covered with straw and earth. Peglia is preferred to Fossi as it affords tubers better protection against cold and rain in winter and prevents the various kinds of rots due to defective ventilation and heating obtained in the Fossi system. The tubers stored in Peglia usually remain in good condition till the

* A quintal is equal to two cwt. roughly.

planting time. In Italy the storage of potatoes for seed is not a problem as it is in India. The amount of rotting of tubers caused by fungi (*Fusarium*, *Sclerotium*) and bacteria is very little owing to the cool climate and the good ventilation of the storehouses. The mean temperature in July, when the potato harvest begins, is not above 75° F., and from November onwards, when the tubers are put in the storehouses, the temperature falls considerably. It is in warm years that damage is sometimes caused to the tubers by the rots. In August 1922, when the writer was in Italy, it was exceptionally warm at Rome and Naples. The maximum temperature was above 90° F. for some days, and therefore he could notice the *Fusarium* and bacterial rots in the fields as well as in the stores. But the rots, he was told, stop as soon as weather becomes normal.

Rotation. Near Naples the crop is rotated with wheat in the first year, maize or hemp (*Cannabis sativa*) in the second year, potato following again in the third year. At other places wheat follows potato, then comes clover in the second year, wheat, maize or hemp in the third year and then potato in the fourth year.

Varieties. (1) The potato known in Bombay as Italian white round is the one grown very widely and is called Riccio. It is a hardy, high yielding variety withstanding rough handling to a considerable extent and is of two types. One of these has white flesh; the other has yellow flesh. The latter is more commonly grown and is said to be a little bit later than the former. (2) A second variety consists of long white tubers and is called Nostrale. It is said to be less susceptible to blight (*Phytophthora*). (3) The third is called Patata Rose. It consists of pebble-like tubers with a reddish skin and eyes. (4) And lastly, there is a very early variety maturing in three to four months, which is called Matilde. Riccio is exported in bags and the remaining three varieties, being delicate, are packed in chestnut wood boxes.

Diseases. It is interesting to find that the potato crop in Italy is practically free from the fungus and insect diseases, particularly from those that come under the Destructive Insects and Pests Act. The belief that the potato moth (*Phthorimea operculella*) must have been introduced into India along with the Italian potato, therefore,

would seem doubtful. The writer was told by Professor Sylvestri, the Entomologist and the Director of Agricultural Institute, Portici, Naples, that the moth has never been recorded in Italy though it occurs in the Malta Islands and Egypt. The moth reached Sicily only once with a consignment of tomato plants from Egypt, when it was immediately destroyed, and since then the solanaceous crops have been listed under the Pests Act. The only disease that is sometimes destructive to the potato crop is blight (*Phytophthora*), for which the crop is regularly sprayed. The following diseases have, however, been recorded, but no special study of these has been made since they do not do any damage to the crop :—

Ring (*Bacillus solanacearum*),

Fusarium,

Eelworms.

None of the destructive diseases that are prevalent in other countries of Europe, viz., wart (*Synchytrium endobioticum*), mosaic, and leaf-roll are said to occur in Italy. One fact, however, that attracted the writer's attention was that the cultivator replenishes his seed from the hill tract whenever the crop degenerates. The recent study of the subject of degeneration has shown that degeneration is but a symptom of a disease and this disease is probably mosaic.¹ It is, therefore, probable that a more thorough study of the degeneration question in Italy might reveal the existence of mosaic disease which is now supposed to be non-existent.

Resuming this short account of the potato cultivation in Italy and contrasting it with that in the Bombay Deccan, the following points arrest attention :—

Italy	Bombay Deccan
Potato is a rain crop.	It is an irrigated crop, at least in <i>rabi</i> season.
It requires 5 to 6 months to mature. It is practically free from fungus and insect diseases. Moth and wart have never been recorded. Ring has not been known to do any damage.	It ripens in 3½ months. The crop is much damaged by moth, ring and <i>Fusarium</i> diseases.
Storage of tubers is not an important problem and therefore the cultivator preserves his own seed. It is only when the crop degenerates that he gets the seed from the hills.	Storage is extremely difficult, as there is a considerable amount of rotting of tubers. The cultivator therefore has hitherto been unable to preserve his seed and is dependent on the Italian tubers.
Average yield is 6 to 7½ times the seed rate.	It is the same here too.

¹ Salaman. Degeneration of Potatoes. *Rep. Internat. Potato Conference of 1921*, pp. 79-91.

CATTLE BREEDING.*

BY

WILLIAM SMITH,

Imperial Dairy Expert.

I AM aware that the Committee now sitting in Poona is one mainly concerned with cattle breeding as it specially affects the Presidency of Bombay, but I am sure the Committee will not object to my dealing with the matter from an all-India point of view and on general lines.

I think it is well in dealing with a subject like this to endeavour as far as possible to state—

- (1) The present condition of the industry,
- (2) Causes of existing conditions, and
- (3) Steps to be taken to improve existing conditions.

As regard (1), I have now been in India for sixteen and a half years during the whole of which time I have been in very close touch with the cattle breeding industry in the Punjab, the United Provinces, Central Provinces, Sind, Bombay and Madras, and it is my considered opinion that in these parts of the country the quality of the cattle has declined since I came to India, or to put it more definitely, I believe that, generally speaking, it is impossible in the open market to-day to procure in quantity, no matter what the price may be, as good draught bullocks and milch cows as were obtainable 16 years ago. Most certainly the quality of milch cattle available in India, except in the district of Sind, is very much worse than those available 16 years ago. If that be so, it behoves us to look for the reason for such a decline at a time that practically every other country in the world has been able to improve the quality of its cattle, and the root reason undoubtedly is want of

* Note submitted to the Bombay Cattle Committee, 1922.

knowledge, accentuated by many circumstances such as the spread of irrigation canals and conservation of forest lands with consequent diminution of grazing areas, the increased facilities for transport and consequent mixing of breeds or types, increased prices for human foodstuffs, and the deliberate and erroneous teaching by the departments responsible for cattle breeding that the development of dairying or milk production would injure the draught quality of working bullocks. I look upon it that the wilful elimination of milking qualities in the stud bulls issued by Government for breeding purposes and the persistent teaching of all concerned in cattle breeding for many years in India that dairying or heavy milking qualities of dams are injurious to the qualities of plough cattle have probably done more harm to cattle breeding in India than any thing, because this elimination of milk-giving qualities strikes at the root of the whole industry. So little attempt has been made to develop milking quality of most breeds of Indian cows that the dams even of some of the finest breeds of cattle are unable to suckle their young within a reasonable time, which means later maturity and fewer calves during the lifetime of the dam.

In time past this did not matter so much, as great breeding areas were available which were useless for any other purpose, but these areas now grow cotton, or pulse, or wheat, and what must take their place. The ordinary cultivator must take their place, and to enable him to do this profitably he must have a cow which will give sufficient milk and *ghi* (clarified butter) for his family and at the same time rear a good draught bullock. As things are now, the cultivator in India keeps one or two or three cows which can hardly produce enough milk for their calves, and he keeps a female buffalo to give milk and *ghi* for his family. This female buffalo is quite unnecessary if the breeder can get a cow which will rear the calf and in addition provide the breeder with milk and *ghi*. Nothing is more certain than that the dam of any type or class of good working bullock whatever can and ought to be a first class milker. We hear many people say that the solution of the cattle breeding problem is to grow more fodder but that is putting the cart before the horse. What we want is fewer but more efficient cattle. No

country in the world can afford to keep a cow which is only capable of suckling a calf. The enormous increase in the number of buffaloes in India is the cause of the fodder shortage, because not only is the female buffalo used because the cow is such an inefficient milker, but the male buffalo is often permitted to survive. This male is useless for draught in most parts of the country, and between the female buffalo used because the cow is not as good a milker as she might be and the useless male buffalo the country is drained of its fodder to such an extent that there is not sufficient for any class of cattle.

The solution of the whole matter lies in the dual purpose animal. No matter what class or type of male plough bullock is required, the dam must always be a good milker, and all bulls issued for stud purposes must be got from heavy milkers as well as be of the right size, type and class.

This country can produce all the draught cattle it needs, more than all the dairy produce it can consume from much fewer cattle than we now possess, but they must be more efficient cattle and they must be *dual purpose* every time. Any propaganda outside of *dual purpose* efficiency is only perpetuating a great economic evil. No other basis can be profitable.

If these are the reasons for the present state of affairs, then the first steps to remedy matters is dairy education. In every civilized country in the world to-day dairying occupies a very prominent position in its Agricultural Department. There is not, at the present moment, a single dairy school in India. The crying need of this country agriculturally is dairy education, both of the cultivator and the masses. Not only is the education of the men in the street necessary from the cattle breeding point of view, but it is necessary from the point of the health and general well-being of the people. The milk supply of our cities is probably the worst and most expensive in the whole world, which fact in itself is a proof of the crying need of the dual purpose cow. We do not need beef and the country does not want it, but milk and draught we must have and it is indisputable that these qualities can and must be combined in the cow of the future.

In this note I, of course, have not touched details of any kind but have confined myself to basic policy, because and until we have our policy based on sure economic foundation we can do nothing. The only practical and sound cattle breeding policy is dairying plus draught qualities ; the one is hopeless without the other and both are inseparable.

A NOTE ON *FUSARIUM* WILT OF GRAM IN BURMA AND MEASURES TAKEN TO COMBAT IT.

BY

A. McKERRAL, M.A., B.Sc.,

Officiating Director of Agriculture, Burma.

IN Burma, the gram plant (*Cicer arietinum*) is grown mainly in the Sagaing, Lower Chindwin, Kyaukse and Myingyan Districts of Upper Burma and in Tharrawaddy in Lower Burma. The total area for the year ended 30th June, 1922, was 119,000 acres. The area is thus small compared with that in some Indian provinces, but nevertheless, owing to its being a true cold weather pulse, the crop is one of considerable importance in Burma. It is often grown on land that is too flooded during the rains for paddy cultivation or when *jowar* (*Andropogon Sorghum*) fails for want of rain, and in the Sagaing and Monywa Districts it is the only suitable crop for rotation with wheat. The result of this is that any circumstance that makes gram growing difficult or impossible leads to the necessity for growing wheat crops for successive years on the same soil with the usual result of diminished yields and profits, while in other cases it may prevent cultivators from getting any crop at all. If possible, the rotation adopted is a two-year one of wheat and gram, no other crops being grown.

The soils of the wheat-gram tract are heavy black clay loams, very similar in appearance and texture to the "black cotton" soils of Central India and the Deccan. The Burma so-called "black cotton" soils are alluviums of great depth and the underlying rock does not reveal itself except when very deep borings are made. Their origin is probably local, and they perhaps represent the last stage in the erosion of the original tertiary rocks. Another theory is that they are old lake bottoms but the Geological Survey

have, I understand, abandoned this theory. The Burmese name of these soils is "Sanè" and they occur over most of the Swebo and Mandalay canal systems, along the railway line in the Sagaing and Monywa Districts, and in isolated patches in many other parts of the dry zone of Burma. In Upper Burma, gram is grown principally on these "Sanè" soils, but in Lower Burma, cultivation is mainly on the riverine alluvium, i.e., on land which is flooded annually during the rains and cropped in the cold season.

Gram is usually sown in late October or in November, the soil having been previously ploughed and harrowed. On principle, however, a fine tilth is not usually attempted, as cultivators believe that the crop thrives best when the surface of the soil is left with abundance of large clods of earth. This is, I believe, an opinion also held by gram cultivators in certain parts of India.

During the last six or seven years, the crop has received attention at the Padu Agricultural Station in the Sagaing District which is in the centre of the principal gram tract. For the purpose of varietal testing for yield a large number of gram types from India were placed under observation at this station. Up to 1918, a variety of black gram gave the best results and it was seen that its superiority in yield to the Burmese type resulted largely from the fact that it was more resistant to a wilt disease which was found to attack the Burmese variety. The black variety, however, is not a type which is in favour with buyers in Burma, and attempts were made to get another which would fulfil their requirements and also be satisfactory in the matter of wilt resistance. This has been achieved by a selection from a variety known as Karachi which appears to have been first introduced in 1918. This strain has proved to be resistant to wilt disease, whereas the black gram which was originally said to be resistant has now (in the present year 1923) shown itself to be highly susceptible.

In 1921, the writer decided to get more definite information on the whole subject of wilt disease during the growing season of that year. With this object a yield test between Burmese and Karachi gram (in quintuplicate plots) was arranged both at Padu and Mandalay, and the growing crop in cultivators' fields was kept

under scrutiny over the more important part of the gram area. The condition of the Burmese variety turned out to be worse than had actually been expected. At Padu, the plots of Burmese gram were completely destroyed by the wilt, whereas the Karachi gram plots showed a fine vegetative growth and a good yield of seed with no dead plants whatever. Widespread damage by this fungus was discovered in cultivators' fields all over the gram area of Sagaing and Monywa, along the railway line in the Kyaukse and Yamethin Districts and at Yawnghwe in the Southern Shan States. The fungus was identified by the Mycological Section at Pusa as *Fusarium* sp.—a fungus closely allied to that which attacks *arhar* (*Cajanus indicus*). The damage varied from a slight attack to almost complete destruction of the crop as at Padu. Cultivators state that they can only escape the effects of the disease by abstaining from sowing gram on the same field for five, six or even (as I was informed in one case) for ten years. As usual the only possible rotation crop is wheat, and this means continuous cropping of the latter with the consequent fall in outturns. In some parts of the Sagaing District the attack was so bad that cultivators were found to refer to their gram fields as "kalape thingyine" or gram graveyards. To sow seed in them was like burying a dead man—nothing ever came up. On the other hand, the Burmese gram plots on the Mandalay Agricultural Station showed no signs of disease, the obvious explanation being that gram had never been grown on them before. In 1922 no attack was reported from the Tharrawaddy District in Lower Burma where most of the crop is new, a large increase having taken place in response to the higher price got for the product in recent years. In 1923, however, closer inspection proved definitely the existence of the disease in the Lower Burma gram areas in the Tharrawaddy and Bassein Districts. The Padu area in the Sagaing District, where the cultivation is old, is obviously very badly infected. It was probably about here and near hand at Ava, the old capital of Burma, that gram was first introduced into Burma from India. That it was so introduced is apparent from its Burmese name "kalape" which means "Indian" or "foreign" pulse. Hence we would expect to have happened what we actually

do find, viz., that the soils of these parts are most highly charged with the disease. A good deal of the gram land in the Sagaing District about Padu is also low-lying and is under water during part of the rains. These conditions, as Butler points out (*Fungi and Disease in Plants*, page 35), are also conducive to increase of this disease, the spores of the fungus tending to be washed down by the rains and to accumulate in the lower areas.

In addition to the varieties already tested, the writer also obtained, through the courtesy of Mr. A. Howard, some seed of each of the 25 types described in *Pusa Memoirs, Botanical Series*, Vol. VII, No. 6. A line of each of these was grown on infected soil at Padu during the past two seasons of 1922 and 1923. Of the 25 types, Nos. 1 to 9 completely succumbed, Nos. 10, 14, 16 and 24 were attacked but not completely destroyed. The rest seemed to be resistant but, with the exception of No. 20, they appear to be too late for Burma conditions.

The behaviour of the black gram mentioned above would appear to indicate that varieties become progressively susceptible but the data available are not sufficient to prove this. Material to test this fact is now at hand in the Karachi and some of the Pusa varieties which have up till now shown themselves completely resistant. Further sowings on infected land will be done with these next year and in successive years and careful counts made in order to get information on this very important point.

That varieties of cultivated plants can become increasingly susceptible and that a variety which is resistant in one locality may be non-resistant in another has been pointed out by Butler in an article on "Immunity and Disease in Plants" in the *Agricultural Journal of India*, Vol. XIII (1918), Sci. Con. No.

In the meantime, the Karachi variety has shown itself so completely superior to the Burmese variety that as seed of it is now available in large quantities, it has been decided to replace the whole existing variety by seed of the Karachi in those localities at least where the disease is known to be prevalent. During the season of 1921-22, seed of the resistant type sufficient to sow 2,500 acres was distributed near Padu and a gram growers' union formed to provide

pure seed for the next season. So great are the losses suffered by cultivators—direct losses owing to the attack of the disease on the gram crop and indirect in that a proper rotation for wheat cannot be got—that in 1922-23 it was decided to accelerate the work. With this end in view 5,000 baskets of seed was purchased back from those cultivators who grew the department's seed in 1921-22, and distribution of this took place before the sowing season of 1922. Distribution of this seed, about 350,000 lb., was arranged through private growers, co-operative credit societies and by Deputy Commissioners giving it as short time loans under the Agriculturists Loans Act. The demand for the seed was great, as the merits of the resistant variety were known to large numbers of cultivators who had been asked to attend a demonstration at Padu while the crop in the plots shown in Plate XXIII was on the ground. During the season the Land Records Department were asked to provide an independent estimate for the area under the new variety. This was returned as 28,000 acres. The initial progress has been satisfactory, and it is certain that by continuing the distribution for two or three years more the desired object will be achieved. In places where disease has not appeared it may not be so easy to convince cultivators of the necessity of a change of seed. In fact the test at Mandalay has shown that where disease does not exist the Burmese variety can hold its own with the introduced. Whenever the least signs of disease are seen, however, a vigorous policy to oust the old variety will be undertaken in order that the state of matters now existing in the disease-stricken areas may not arise.

In connection with this gram work several points of special interest deserve emphasis and recapitulation:—(1) The extreme virulence of the *Fusarium* wilt in certain localities; (2) the actual existence of gram types in India which are at least temporarily resistant and the discovery of which affords a rapid and easy method of relief to cultivators; (3) the very interesting question mentioned above as to how far any type is permanently immune to the disease. In any case it does not appear that so far as gram varieties are concerned there is any literature dealing with this aspect of the

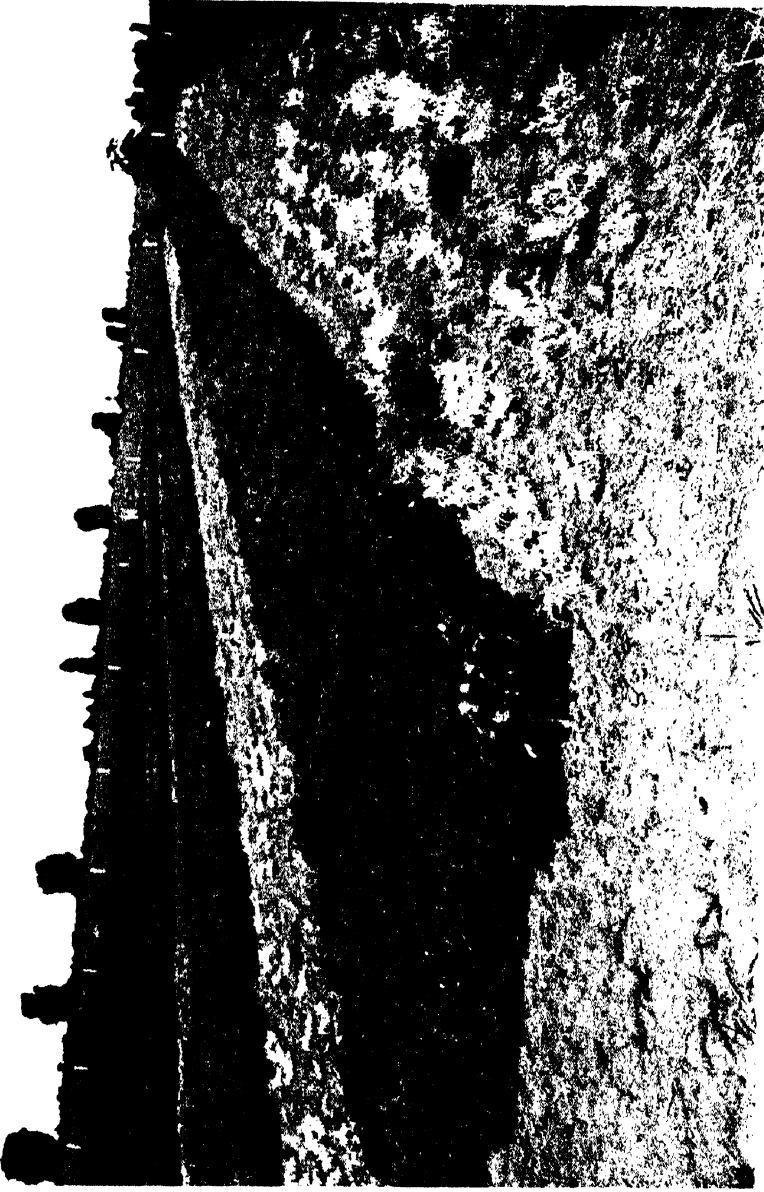

RESISTANT AND SUSCEPTIBLE GRAM VARIETIES AT THE PADU FARM,
BURMA, FEBRUARY 1922.

(A line of soy-bean used to demarcate the plots. An identical result was got in 1923.)

matter, and the first thing to be done is to ascertain definitely whether such deterioration does take place or not.

The replacement of the existing variety in Burma by an immune, or at least highly resistant, variety will mean an increase in the value of the crop of at least five lakhs of rupees per annum.

It is possible that the facts disclosed in this note may be of interest to mycological experts and those officers of the Agricultural Department whose duties lie in the great Indian gram growing areas. Little or no information seems to be available as to the incidence of the wilt disease of gram in India, or the number of really resistant varieties which exist in the country.

EXPERIMENTS ON WHEAT THRESHING AT LYALLPUR.

BY

H. R. STEWART, A.R.C.Sc.I., D.I.C., N.D.A.,
Professor of Agriculture, Punjab Agricultural College, Lyallpur ;

AND

D. P. JOHNSTON, A.R.C.Sc.I., N.D.A.,
Deputy Director of Agriculture, Punjab, Lyallpur.

OUT of a total of over twenty million acres of wheat grown in British India, the Punjab has annually to its credit over nine million acres, or 35 per cent. of the total wheat of the country. Its enormous importance in this province is even better realized when it is stated that, in the canal colonies, the cultivator sows annually eleven or twelve acres of wheat in each square of his land (about 40 per cent.). No research can, therefore, be of greater importance to the Punjab cultivator than anything done in connection with the wheat crop.

The process of harvesting and threshing this crop is a long and laborious one, severe on man and animal, since the work falls at the hottest period of the year. Practically the whole crop is still harvested by hand. Some reaping machines are, it is true, in use, but the area at present covered by them is so small as to be almost negligible. The threshing and preparation of the grain for marketing is, however, a much slower and harder task, in comparison, than the actual cutting. For the zemindar the mere extraction of the grain from the ears is only one phase of the work. He requires in addition that the straw shall be crushed, and broken into very fine pieces (*bhusa*). For generations this has been accomplished by the tedious process of trampling by bullocks with *phalla*. Four bullocks and three men can normally thresh, and make

bhusa of, one acre of wheat in one day. The average zemindar owning a square of land in the canal colonies has four bullocks. He grows eleven or twelve acres of wheat, hence it will be seen that the threshing and *bhusa*-making operations alone take the same number of days. It is customary for the winnowing to be done by casual labourers who receive 5 per cent. of the cleaned grain for their work. If winds are unsatisfactory, this operation may be a very prolonged one. Storms, too, often cause heavy damage, hence early finishing of the work is important.

About 1907, the Punjab Agricultural Department started some experiments on wheat threshing by machinery. The first machine tried contained a threshing drum and concave only, the power being obtained from a bullock-driven gear. It, however, was not a success, and was discarded. About 1911 the department procured two large Ransome threshers of the N. I. L. type driven by a steam engine. Work was continued with them up to 1915. One was a 30-inch, and the other a 48-inch machine. The smaller one gave an output of 4·6 maunds, while the larger machine gave about 10·5 maunds per hour.¹ These machines were sent to Mesopotamia during the war and did not come back, so work on this subject was temporarily interrupted.²

In 1920, two portable, self-driven threshers were brought out from England. These machines were introduced with the object of lessening the difficulty and waste of time associated with the transport and alignment of the ordinary steam engine and thresher outfits which had been tried earlier. It was also thought that they might save much time and labour in the threshing of the wheat, gram, etc., grown on the numerous small experimental plots at the Lyallpur Agricultural Station.

The smaller machine (Fig. 1) is constructed of wood and mounted on iron travelling wheels without springs. Its length is 16 feet 6 inches, width 4 feet 6 inches, height 8 feet, and weight about 36 cwt. A 5 h.p. oil engine is installed at one end of the frame

¹ The working of these machines is described in the *Agri. Jour. Ind.*, X, Pt. 3.

² A machine similar to these was tried at Cawnpore in 1913. *Agri. Jour. Ind.*, VIII, Pt. 4.

underneath the shakers. The power is transmitted to the threshing drum by a belt, which, to facilitate easy starting of the engine, can be moved to a loose pulley. Subsidiary belts, working from pulleys on the drum, operate riddles, shakers and fans. The drum, which is 24 inches broad, is of the skeleton type, with



FIG. 1. 24-inch self-driven thresher working at Lyallpur.

beaters in which pegs ($1\frac{1}{2}$ inches long) are inserted. The concave bars also contain similar pegs. The straw shakers are on the reciprocating principle driven by a single crank. The separations are effected by two riddles with a blast of air passing between them. The grain is raised up for bagging by the usual belt and bucket elevator. The feeding platform is about six feet from the ground, and from this the bundles are fed to the drum horizontally. The threshing action of the drum is a combined beating and combing one. The beaters, acting downwards at right angles to the feed platform, deal very severely with the straw, breaking fully 50 per cent. into coarse *bhusa*. Most of this broken straw passes with the grain, chaff, etc., through the concave and shakers. This bulk is greater than the machine can deal with, and causes choking at the entrance to the caving riddle. This always occurs after ten or fifteen minutes' working, and the time wasted in

cleaning out the obstruction again is usually more than the time spent in threshing. To minimize this fault wide setting of the concave was tried, but the proportion of *bhusa* made was still too high for the machine to deal with. Slow feeding was also tried but without any improvement. Oats, wheat and gram at different stages of ripeness were then threshed, and it was found that if the straw was tough the machine worked very well, its success depending entirely upon the condition of the straw. The highest output of wheat obtained was six maunds per hour. This figure is much too low for the machine to be economical.

The larger machine (Fig. 2) is also constructed of wood, spring mounted on iron travelling wheels; its length is 17 feet, width 4 feet, height 8 feet and weight about 40 cwt. The motive power is supplied by a 6 h.p. horizontal oil engine, also installed within the frame. The internal arrangements of this machine are almost similar to the other with the exception of the drum and concave. This drum (27 inches



FIG. 2. 27-inch thresher with *bhusa* maker attached.

broad) is of the high speed rubbing type, whilst the concave in this case is in two sections, the whole making an arc of 180 degrees. The feeding platform here is on top of the machine. The bundles being fed into the drum at a tangent caused the grain to be extracted from the ears more by a rubbing than beating action; this resulted in a

lower percentage of *bhusa* and less choking in the machine. Setting of the concave to suit conditions played a very important part. If the concave was set too wide, whole heads were broken off and passed through the machine unthreshed; if set too close, a small percentage of grain was broken, and much *bhusa* made, accompanied by the usual choking and flooding of the riddles. The output of this machine, averaged about eight maunds per hour.

The caving riddle which is the first to deal with the large bulk of broken straw, grain, chaff, etc., is too small, being only about 6 square feet in area. The clearance between it and the shakers is also not enough, being only about 6 inches. With the idea of trying to remedy its faults, this machine was taken to pieces and reconstructed. New shakers were made and covered with woven wire ($\frac{1}{2}$ inch mesh) to try and prevent the *bhusa* from falling through to the riddles. The space between the shakers and caving riddle was enlarged, and the superficial area of riddles increased four times. On trial after reconstruction it was found that the shakers were effective in stopping most of the *bhusa*, also that the larger riddles were capable of dealing effectively with all the material thrown upon them. Further, the output of the machine was almost doubled. Owing to its narrowness, this machine is very difficult to feed. The sheaves have to be inserted heads first into the drum which, instead of sucking them away whole, cuts the straw off in pieces. Hence the operator has to keep continually pushing them in. This makes feeding very tiresome, and unless men are changed often considerably lowers output.

With this thresher a separate small machine for making *bhusa* was provided. It consists of two small drums, the first being fitted with numerous cutting sections much resembling those on the knife of a reaping machine. These alternate with similar sections fitted to a concave. The straw on passing between them is chopped up into a fine condition and then passes to the second drum which is fitted with conical pegs. Between these and another concave containing similar pegs it is thoroughly bruised. This machine makes very good *bhusa* but suffers from the fault that, as designed, the thresher and *bhusa* maker cannot be worked simultaneously by

the engine. Actual threshing had to be done first and *bhusa* making later. In the subsequent reconstruction of this thresher, the *bhusa* maker was fitted on so that the straw on being delivered by the shakers passed into it and was finally ejected as *bhusa*. This, however, necessitated the removal of the engine which drives the thresher, and a tractor had to be employed to supply the driving power. Whilst all the operations could thus be performed at once, it was not economical as the small oil engine runs at a much lower cost than a tractor.

Both these machines working under European conditions would probably give satisfaction, but they are unsuited to a dry climate like that prevailing in the Punjab, where the straw of ripe grain will never be found tough as it is in England.

The framework of both machines gave much trouble, due to the wood warping and joints working loose. Where lubrication was not automatic, bearings caused many delays by heating up. The temperature in the threshing season is anything from 100° to 150° F. in the sun, and for this reason machines constructed of wood are almost certain to have a short life here.

Another "all steel" thresher was tried last harvest; it is also portable, about 10 feet long, 5 feet broad, 5 feet high, and weighing about 20 maunds. The driving power was supplied by a tractor. Simplicity is the dominating feature in this machine as it contains drum, shakers and fan only. Its 42-inch broad drum is of the high speed rubbing type. Owing to its breadth this machine was very easily fed, the sheaves being thrown into it diagonally. The output was about 16 maunds per hour. Its great drawback is that it only partially cleans the grain. Fewness of working parts is its strong point, as it can be run almost continuously without stopping from mechanical troubles, etc.

When the wheat crop is being cut, the prevailing custom is to tie it up in large bundles weighing over a maund with heads and butts all mixed up. These bundles are much too unwieldy to lift on a threshing machine, besides when heads and butts are mixed the drum will not readily take it in. Here, for convenience, we have adopted the English system of tying it in small bundles

about 9 inches in diameter with heads all in one direction. These are easier to handle and more readily taken in by the machine.

The general conclusion arrived at as a result of these trials is that the simpler and less complicated the machine, the more likely will it be to achieve practical success here. Its chief aim should be to thresh well both as regards quality and quantity and to effectively separate grain and straw. It is, however, strongly felt that no machine will be entirely successful, or in much demand here, that does not turn out the threshed straw in the form of *bhusa*. The Punjabi zemindar has from time immemorial fed his straw in this state, and discussion with him on this subject invariably shows that it is one of the first requisites in a machine which he will demand. Neither of the two small wooden self-driven machines can be recommended. Their outturn is much too low, the quality of their work poor, and the material of which they are made unsuited to the climate. The small all-steel thresher already described is a much better machine than either of these. Its outturn is very fair and the quality of the threshing good. Driven by an oil engine of 6 b.h.p., it can be run very economically. Some small alterations in its construction were deemed advisable, and it is hoped to have the privilege next year of trying another such machine embodying some of these alterations. Its only drawback, so far as can be foreseen, is that the straw after being threshed will have to be converted into *bhusa* by other means. Out of all the machines so far tried, the full size steam-driven machine producing *bhusa* appears still to hold the premier place.

Selected Articles

ROTHAMSTED AND AGRICULTURAL SCIENCE.*

BY

SIR JOHN RUSSELL, F.R.S.

THE Rothamsted Experimental Station has just passed its eightieth year, having been founded in 1843. Its study has always been the growth of crops, with periodical excursions into problems of utilization; the method of experiment has always been essentially statistical in that the field experiments were repeated year after year without modification, with the result that a unique mass of data has now accumulated which is proving of the greatest value for statistical investigation.

The work at Rothamsted falls into two great periods: the first when Lawes and Gilbert were actively exploring the possibilities opened up by the knowledge of plant nutrition gained by the early nineteenth-century workers; and the more recent period, when close study of the soil has revealed certain factors of high scientific interest, and, one is constrained to believe, ultimately of great practical importance.

The great problem which Lawes and Gilbert set out to solve was to account for the fertilizing value of farmyard manure. The fact was well known, but there was no satisfactory explanation. Lawes and Gilbert proceeded by a method that still—after eighty years—remains our best. It was known that farmyard manure contained three groups of components: organic matter; nitrogen compounds; and ash constituents—potassium, calcium and magnesium salts, phosphates, silicates, etc. They therefore arranged

* Discourse delivered at the Royal Institution on 9th February, 1923. Reprinted from *Nature*, No. 2788.

vegetation tests with these various groups. The old idea was that the fertilizing value lay in the organic matter, but Liebig, in 1840, had argued brilliantly against this view, and suggested instead that the ash constituents, especially the potassium, calcium and magnesium salts, were the effective agents. Lawes and Gilbert were prepared to recognize the necessity for these mineral salts, but insisted that the nitrogen compounds were equally required. To put the matter to a test, they laid out four plots of ground, receiving, respectively, no manure, farmyard manure, ashes of an equal amount of farmyard manure, and these ashes plus a nitrogen compound (ammonium sulphate). The results were as follows:—

Produce of wheat per acre, Broadbalk Field, Rothamsted, 1844.

	Grain (bush.)	Straw (cwt.)
No manure	16	1,120
Farmyard manure (14 tons per acre)	22	1,476
Ashes of 14 tons of farmyard manure	16	1,104
Ash constituents + nitrogen compounds and ammonium sulphate, up to	26½	1,772

They concluded that farmyard manure owes its value, not to the organic matter as was for long supposed, nor to the ash constituents as Liebig had suggested, but to the ash constituents plus nitrogen compounds.

Now this discovery was of the greatest importance in plant physiology, but Lawes and Gilbert did not follow it up in that direction. Instead they applied it at once to an important agricultural problem then ripe for solution. There was then (as nearly always now) a shortage of farmyard manure on farms, and agriculturists had for generations sought for substitutes, but with little success. Lawes and Gilbert saw that the mixture of ash constituents and nitrogen compounds would form an effective substitute, and further, that it could be obtained in very large quantities, and of course independently of farmyard manure. Geologists had discovered vast deposits of calcium phosphate, which chemists had shown how to render soluble. Engineers were developing the manufacture of coal gas and producing large quantities of ammonium sulphate, while potassium compounds could be obtained without difficulty from wood ashes. Lawes and Gilbert therefore

proceeded to make mixtures of these substances which they advised farmers to use.

Few experiments have proved so fruitful in stimulating scientific inquiry—it is still opening up new fields at Rothamsted—and in ministering to human needs, as this simple field trial carried out eighty years ago on the Broadbalk field at Rothamsted. At first farmers looked with some misgiving upon this new kind of manure (which was called “artificial manure” to distinguish it from farmyard manure, then known as “natural manure”); it seemed incredible that a harmless-looking powder without smell or taste could act as potently as the old-time richly odorous farmyard manure. But they soon came to recognize its value, and before long they were using many thousands of tons a year. It is safe to say that the remarkable development of British agriculture which took place between 1843, when Rothamsted began, and 1870, would have been impossible without artificial fertilizers. During that period British farmers kept pace with the growing needs of the population; indeed they did more, for they helped to change the “hungry ’forties” into the more plentiful ’seventies. The use of artificial fertilizers is now developed throughout the civilized world and the industry has attained enormous dimensions.

This was the greatest achievement of Lawes and Gilbert. They did many other things for the farmers of their day, but this alone leaves us owing them a great debt of gratitude.

As the use of artificial fertilizers spread there arose, as one might expect, many problems of great scientific interest or technical importance. Thus it soon appeared that weather conditions profoundly affected the response of crops to artificial fertilizers. The same fertilizer mixture which in one season gave results fully equal to, or even surpassing those of farmyard manure, would, on the same farm and even in the same field, prove a failure in another season. This is well shown in the fluctuations in yield on the Broadbalk wheat field at Rothamsted.

The effect of soil is also sharply marked. On our heavy soil at Rothamsted the best results are usually obtained by a fairly liberal use of phosphate, but there is less necessity for large dressings

of potash. But on the much lighter soil of Woburn potash is considerably more important, while phosphates are less needed, and, indeed, beyond a certain quantity appear to do actual harm. It is obvious, therefore, that a complete manure drawn up on the basis of the Rothamsted experiments would fail in practice to give the best results on a lighter soil. As an instance the following may be quoted, this being one of a general scheme of experiments organized from Rothamsted :---

Barley : Light sandy soil in Suffolk, 1922.

	Bush. per acre
Complete artificial manure	21.5
Incomplete manure : phosphate omitted	27.5
No manure	16.0

In this instance the omission of phosphates has raised the yield by 6 bushels per acre. As against this, an array of instances might be brought from clay farms where a phosphate is the one and only thing that causes crop increases. Any one who had

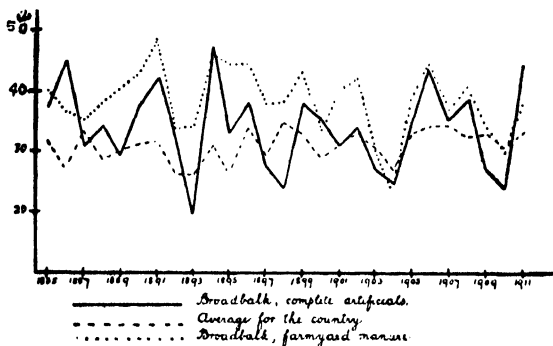

FIG. 1. Yields of wheat from Broadbalk plots manured with complete artificial manures, and farmyard manure, respectively, compared with the average yield for the whole country.

to deal with farmers' problems could multiply apparent contradictions and inconsistencies of this kind. When one collects, as we have done at Rothamsted, the results of field trials with artificial manures made in different parts of the country, they seem at

first to be simply a tangled mass of unrelated facts.

Now it is the business of the man of science to sort out a tangle of this kind, to reduce it to order, to find the general principles running through it, and finally to prove the correctness of his conclusions by being able to predict with certainty what will happen in given conditions. The recognized method of procedure is to discover the various factors at work and investigate them one at a time.

This is being done at Rothamsted in two ways: by field observations, and by quantitative laboratory measurements. Observations in the field show that each of the fertilizing substances—phosphates, potassium compounds, nitrogen compounds, etc.—in addition to its general effect in increasing plant growth, produces certain specific effects which may be of advantage, or may be a disadvantage to the plant in the particular conditions in which it happens to be growing. Thus, phosphates have a special influence in hastening the ripening processes, which no doubt accounts for the Suffolk results just quoted. In the dry conditions of a sandy soil, ripening is already too early, and any reduction in an already short growing season cuts down the yield; in cold, wet districts, however, this property is very valuable.

In the early stages of the plant's life phosphates stimulate root development to a marked degree; this is well shown in their effect on swedes. Nitrogen compounds tend to increase leaf development and give greater vigour of growth, but beyond a certain point the advantage is counteracted by a loss of resisting power, and the plants may fall victims to attacks of disease. Crops—especially cereals—may be unable to stand up against the weather and may become "lodged." Indeed, the proper adjustment of plant nutrients affords plant pathologists one method of dealing with plant diseases.

Qualitative observations of this kind, while of high value, are not entirely sufficient: it is necessary to have quantitative measurements of as high an order of accuracy as possible. At Rothamsted this is done by means of water cultures and pot experiments; all the factors are controlled as closely as possible and the results are plotted on curves which can be studied in detail. This method was developed extensively by Hellriegel and is now in common use in agricultural laboratories.

The method naturally invites mathematical treatment, and attempts have been made, notably by Mitscherlich, to express the curve by equations. There is a seductive look about a mathematical formula which rarely fails to appeal to the biologist, but as a rule the number of experimental points obtained is much too

small to justify mathematical treatment, and it is not surprising that investigators fail to agree. Ten years ago the fashion was for logarithmic curves; now it is for sigmoid curves, which are probably nearer the truth, though not yet a complete expression.

This method of studying single factors is pushed to a high degree of refinement in plant physiology laboratories, such as that of the Imperial College under Prof. Blackman, or that under his brother at Cambridge, and there can be little doubt that the effect of individual factors on the plant will ultimately be well known. All this work is giving valuable information as to causes and principles.

These curves show the relationship between yield and plant food supply at one particular temperature which remains constant, and one particular water supply which also remains constant. But a completely different set of figures would be obtained if the temperature were different or if the water supply were altered. Supposing one wished to take account of the effect of water supply as well as food, one would draw a series of curves, which would properly be expressed as a surface, and this has been done by one of the Rothamsted workers—Mr. J. A. Prescott—to show the effect of nitrate supply and spacing on the yield of maize in Egypt. The experiments had the advantage that the climatic conditions are less fickle there than here. It would be of the greatest interest to obtain such surfaces for other pairs of factors.

If an attempt were made to study factors three at a time, it would be necessary to prepare a series of surfaces and to embody them in a figure in four dimensions, which is certainly beyond the capacity of the ordinary agricultural investigator. But in agricultural field work the factors do not vary one at the time, or even two or three at the time; there may be half-a-dozen variables. This, of course, enormously complicates any attempt to apply to field conditions the results obtained by these single factor physiological experiments. It is possible that when the physiologists have completely elucidated all the single factors, some one will be able to synthesize the material and build it into some great conception or expression that will contain all, and thus account for the field results.

But history shows that the genius capable of effecting a synthesis of this sort is very rare and might have to be awaited long.

We have therefore adopted another method at Rothamsted, which is being worked alongside of the single factor method. Statisticians have, during recent years, been evolving methods for dealing with cases where several factors vary simultaneously. These methods have been applied by Mr. R. A. Fisher to the Rothamsted field data, and he has been able to trace certain statistical regularities which foreshadow the possibility of important developments.

Thus, the yields on the Broadbalk wheat field vary every year, apparently in a most erratic manner. But analysis of the figures showed that the factors causing variation could be disentangled and

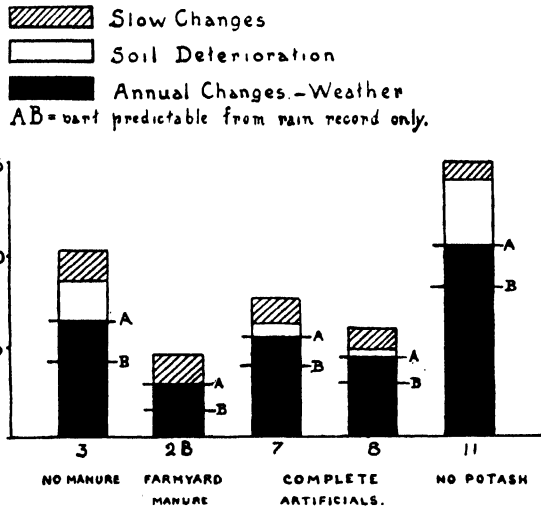

FIG. 2. Mr. R. A. Fisher's results showing amounts of predictable variation in wheat yields, Broadbalk, Rothamsted.

expressed quantitatively; there are slow changes in the field, such as changes in the amount of weeds, etc.; deterioration of soil; and weather changes such as rainfall, temperature, etc. (Fig. 2.)

As might be expected, the effects differ according to manurial conditions; e.g., the influence of weather varies with the manure. Important differences appear between farmyard manure and artificials. The variation in yield is less where farmyard manure is given than where artificials are used. Further, the so-called complete manure appears not really complete at all; there is soil deterioration going on; but with farmyard manure no such deterioration is produced. The different kinds and quantities of artificial manures produce different effects on the variation in yield, the magnitude of which has been worked out.

Having disentangled the factors Mr. Fisher has proceeded to analyse the effect of rainfall, and he finds that part of the weather effect is predictable when rainfall is known. Rain above the average in autumn is somewhat beneficial; in winter and in summer it is harmful, and in spring it is less frequently harmful. As before, the effects are much more pronounced with complete artificials than with farmyard manure. The actual facts have long been known in a general way, but here is an exact quantitative measurement.

The great advantage of this statistical regularity is that it indicates the possibility of expressing in terms of chance the influence of the weather, soil, etc., on crop yields. We hope ultimately to be able to say to the farmer, given such and such conditions of soil and weather, the chances are so many to one that such and such an increase of yield will be obtained by the use of a specified fertilizer. The expression would be understood by every farmer, and he would readily decide whether to take the risk or not.

Much greater results would also follow. At present the farmer cannot cover his risks of low yields by insurance, the companies not yet having sufficient data. We hope and believe that these statistical investigations will afford the basis on which such data will be obtained. At present the position approximates to that of life insurance in the eighteenth century, when the statistical regularity of mortality was first established, after which the first life tables could be constructed. There still remains a mass of detail to work out, but the fundamental problems are now being attacked, and we see no reason to regard them as insoluble. If the expectancy of crop yields proves to be calculable the farmer will be able to insure himself against crop failure, and so meet one of the worst vicissitudes of his troubled life by merely taking out an insurance policy—perhaps even by subscribing to a particular newspaper.

We are constrained to admit that the work is still far from completion, and in the meantime agriculture has fallen on difficult days and farmers are turning to us to ask how they can obtain large crops in the most economical way. It is not general principles they want, but particular instructions.

We are not in a position to give an absolute clear cut prescription to any farmer, but we are going a long way to meet him. Some of our field experiments of special interest or importance are being repeated at other centres where soil and climatic conditions are all different. The results are compared with ours, or with others that have been obtained, to ascertain how far or in what direction any of our conclusions would need modification in a particular district.

We now return to an important result to which I have already referred. Over a period of years the artificial manures have not proved quite as effective as farmyard manure; there has been more variation in yield and they have not so well maintained the fertility of the soil as farmyard manure has done. On some crops the effect is marked; clover responds better to farmyard manure than to artificials. It appears then that Lawes' and Gilbert's views that the fertilizer value of farmyard manure lay in its ash constituents plus nitrogen compounds is only a first approximation, and that farmyard manure does something or contains something which artificial manures do not. This difference we are now engaged in exploring.

The same method of procedure is used as in studying the effects of artificial fertilizers. A full scientific investigation into the causes is carried out, but simultaneously an attempt is made to find some working solution of the farmers' problems. The shortage of farmyard manure is still as acute as ever, and to keep more animals with the view of making more is uneconomic. At Rothamsted we have attempted to produce farmyard manure from straw artificially and without animals. This has been done by Mr. E. H. Richards and Dr. Hutchinson by simulating the essentials of the natural process, namely, watering straw with a salt of ammonia (actually ammonium sulphate, but calcium carbonate is mixed with the straw), and leaving the heap so that the air can get in and the organisms can do their work. The product is not yet equal to the natural substance, but it is steadily being improved, and the very serious difficulties are gradually disappearing in Mr. Richards' competent hands. Five years ago a few ounces only of this artificial farmyard manure had been prepared; last year several thousand

tons were made on various farms in different parts of the country, and the news is spreading. The serious problem of developing the work from the laboratory to the farm scale has been possible through the generous and public-spirited action of Lord Elveden. There seems here the possibility of aid to the farmer and of the development of an important new industry.

Meanwhile a full scientific investigation is being carried on to discover wherein farmyard manure differs from artificials. One important difference is already known and is being investigated by Dr. Keen. Farmyard manure opens out the soil particles leaving bigger pore spaces; it allows of the retention of more moisture and the better circulation of air. All these effects are beneficial.

There is also another difference. Farmyard manure and also plant residues (which are substantially the same thing) decompose in the soil, giving rise to many substances of different types. The plant foods are among the end products: indeed, in natural conditions, and, to a large extent, in farms and gardens also, it is in this way that plants obtain their food. In using artificial manures we supply these end products at once instead of waiting for them to be liberated gradually by the natural decomposition. Further, we do not by any means know the whole of the processes whereby plant food is made. But there are certain intermediate products, and it is quite possible that some of these may have a special effect on the growing plant. Curious stimulating effects are produced by substances formed when soil is steamed, or when oxidation is accelerated by addition of charcoal, and we have obtained the same results with small quantities of picric acid; such bodies might well be formed as intermediates in the decomposition of farmyard manure. The whole effect suggests an action like that of the vitamins of plant physiologists or the auximones of the late Prof. Bottomley. The chemical department at Rothamsted, under Mr. Page, is following out the process, and the botanical department, under Dr. Winifred Brenchley, will test any intermediate products which may be obtained.

A further important factor, which probably governs the whole situation, is that a great part of the process of decomposition

and plant food production appears to be brought about by living organisms in the soil. Simultaneously, therefore, with the chemical and botanical investigations, the various biological departments are busily engaged in studying the organisms that are doing the work.

It is a wonderful story that is being revealed. The soil is shown to be the abode of a vast population of living organisms of the most varied kind. Some of them are remarkably small; among them one which brings about the last stage in the formation of nitrates—an organism which Rothamsted just missed forty years ago: another, also just missed at Rothamsted, which has the remarkable property of fixing nitrogen in the nodule of the clover plant. Others are larger and more easily picked out, but their exact place in the soil economy is not easy to determine: probably they are concerned in the preliminary stages of the decomposition.

It is impossible to peer into the soil with a microscope, so that indirect methods of exploration have to be used. At Rothamsted the organisms are counted and the work they do is estimated by some chemical process: virtually we take a census of population and production in the soil. Like other census methods, it is comparative only: a single census is not much use; it is not until several have been taken that one can find how the numbers and activities of the population are being affected by various conditions. The census is therefore repeated periodically and the results plotted on curves from which it is possible to deduce the effect of various factors on the particular organisms counted.

These curves brought out the remarkable result that partial sterilization increased bacterial activity, and investigation showed that the normal virgin soil must contain other organisms besides bacteria—organisms, moreover, which were detrimental to bacteria and tended to keep their numbers down. A search for such organisms showed that protozoa were present: many forms have since been found in the soil, some of which are known to feed on bacteria. Mr. Cutler has discovered how to count them, and with the co-operation of willing workers has succeeded in carrying out perhaps the most remarkable census yet made of the bacterial and protozoan population of a natural field soil. Before the census

began many months were spent in perfecting the methods and technique, and in making preliminary studies of the soil. The details were carefully arranged with the statistical department, and it was decided to take the census many times at short intervals. Time to a bacillus or a protozoan is a different thing from what it is to us, and instead of taking the census every ten years, or even every ten days, it was taken daily, and at the same hour every day. Many repetitions were needed so that the statistician might feel safe in drawing conclusions from the data. The census was therefore made every day for 365 consecutive days, and no less than seventeen different organisms were enumerated.

A team of five workers kept the investigation going without intermission—Sundays, Bank Holidays, and Christmas Day—for a whole year. A mass of data was obtained of high statistical value which is proving of the greatest importance in the study of the soil population. One of the most interesting results was the proof that the soil population is not steady in number as had always been assumed, but is in a violent state of flux. Every organism observed—protozoon or bacterium—showed great daily variations, which seemed to be independent of external conditions. At least one showed a two-day periodicity. The fluctuations of the amœbæ were of special interest as they were exactly the reverse of the bacterial fluctuations. Close examination of the curves leaves no doubt that the fluctuations of the amœbæ cause the fluctuations of the bacteria, high numbers of amœbæ causing low numbers of bacteria, and low numbers of amœbæ allowing bacterial numbers to rise : but why the amœbæ fluctuate remains a mystery.

In the case of bacteria it has been possible to make even closer observations. A census organized by Messrs. Thornton and Page has been taken each two hours for several days and nights ; but again the same wonderful fluctuations are seen. As might be expected, the amount of work, as measured by the nitrate present, alters from hour to hour. But the curve was not quite what was expected : the increases in amount of nitrate could be understood as representing the work done by bacteria, but the decreases were more difficult to explain. There was no rain to wash it out and

there were no plants to take it up; yet the nitrate tends to disappear. The results suggest that some organism is absorbing it. Algæ and fungi could both do this, and both are found in the soil: Dr. Muriel Bristol and Dr. Brierley are closely studying them.

Perhaps even more remarkable than the daily changes are the great seasonal changes. It appears that the whole soil population is depressed in winter and in summer, and is uplifted in spring and autumn. How this comes about we do not know. The phenomenon does not seem to be confined to the soil; the algæ in a pond and the plankton in the sea, like the organisms in the soil, all seem to feel the joy of spring; it is as if Virgil had got hold of some great truth in natural science, which we have not yet been able to express in cold scientific terms, when he says that in spring "Aether, the Almighty Father of Nature, descends upon the earth, and blending his mighty frame with hers, gives life to all the embryos within." ("Georgics," Bk. II, 11, 324-327.)

The number of organisms in one single gramme of soil—no more than a teaspoonful—often well exceeds 40 millions. This looks big, but it is difficult to form an idea of its immensity. If each unit in the whole array could be magnified up to the size of a man and the whole caused to march past in single file, they would go in a steady stream, every hour of the day and night for a year, a month and a day, before they had all passed. We must think then of the apparently lifeless soil which we tread beneath our feet as really throbbing with life, changing daily and hourly in obedience to some great laws which we have not yet discovered; pulsating with birth, death, decay, and new birth. And if the wonder were not sufficient, we know that in some way these lowly organisms are preparing the food for our crops—the crops on which we ourselves feed. It is possible—it is even probable—that our attempts to learn something of this wonderful population may lead to some degree of control which would have valuable economic results. But even if this never happened the work would still be justified because it shows to the countryman something of the abounding interest of his daily task and of the infinite wonder of the soil on which he spends his life.

DANISH AGRICULTURE AND THE HYGIENE OF THE NATION.*

IN a Chadwick Lecture recently delivered at the Royal Sanitary Institute, Mr. Nugent Harris gave some interesting particulars of Danish agriculture. Forty per cent. of Denmark's aggregate population, which numbers three million people, subsist on agriculture. This figure does not include the South Jutland territories, in respect of which there are not yet available agricultural statistics which may be compared with the Danish figures. No other Danish trade provides occupation for such a large part of the Danish population, and thus we may be justified in describing agriculture as Denmark's main industry. We are still further justified in doing so by the fact that among the trades it is first and foremost agriculture which hitherto has supported the economy of the country, procuring through export 80—90 per cent. of the foreign means of payment which is an essential condition of commerce with foreign countries.

In its present form Danish agriculture came into being in the eighties. During these years an important change was effected by which Denmark, from being mainly a corn-selling country, became a corn-buying country, attaching special importance to the production and sale of animal products, more especially butter, pork and eggs and such live stock as slaughter-cattle and draught-horses. These products constituted about 95 per cent. of the total Danish agricultural export.

The means which Danish agriculturists adopted in order to secure this special production was the breeding of a live stock of a very high quality. In the summer of 1914 this live stock consisted of 567,000 horses, 2,463,000 head of cattle (including 1,310,000 head of dairy cattle), 2,497,000 pigs and 15,130,000 fowls. For the support of this stock not only the greater part of Denmark's own

* Reprinted from *Jour. of Roy. Soc. of Arts*, No. 3687.

crop was required, but also considerable quantities of fodder from abroad, principally about 600,000 tons of oilcakes and about 400,000 tons of maize, the quantity always varying, however, in accordance with the Danish crop. Considerable quantities of artificial manure, nitrate, phosphate, and potash, were required to maintain the quality of Danish soil at the level necessary for such an enormous live stock.

Danish agriculture fell into great difficulties during the war, especially during its last phases, when the tightened blockade rendered it difficult to get supplies from abroad. The most strenuous endeavours were used to ward off and mitigate the effects of the blockade, partly by means of forced home production of fodder, partly by means of special efforts to encourage the best breeding material among the live stock. When the seas were re-opened to the free exchange of goods, Danish farmers at once proceeded to increase to its full extent the live stock which all quarters admitted to be of vital importance to the future economy of Denmark. These endeavours succeeded.

Before the war, 2,463,000 head of cattle existed in Denmark. Of this number, 1,310,000 were milch cows. The annual export of cattle and meat was equivalent to about 300,000 head in all, while the export of butter amounted to about 100,000 tons yearly. The exclusion of foreign fodder had a serious influence on the number of the live stock and impaired its capacity, so that the quantity of milk in 1918 was only about half the normal quantity. But now conditions have become again almost normal, and at the same time the Danish butter market has been extended beyond England, and includes Switzerland, Germany, Sweden and Norway, and even America, to which country considerable quantities of Danish butter are sent. In 1922 there were in all 2,286,000 head of cattle, of which 1,113,000 are milch cows, a somewhat lower figure than that of 1914, but, of course, it has not been the poorest animals which have been preserved, but quite the contrary. The quantity of milk is now almost the same as it was before the war.

Industrial conditions applied more to pig breeding than to any other branch of agriculture, and it was, therefore, a natural

consequence that it should be hard hit by the blockade. But here again special stress was laid on the necessity of keeping the best breeding animals, and these endeavours were crowned with success, so that the number of pigs is now fully one and a half million as compared with only about 513,000 in 1918. It will not be long before Danish agriculture will reach the level of the stocks held before the war, when the number of pigs was about 2·5 million, and when the annual slaughtering at 61 Danish abattoirs amounted to about 3 million pigs.

As to egg production, this became very important during the war, especially for farming in a small way. Here, again, Danish agriculture hopes soon to be able to produce about 500 million eggs annually, and these together with 300 million which are eaten in Denmark, constitute the country's total production of eggs. Buyers for this produce are to be found everywhere.

DANISH AGRICULTURE AND THE REBUILDING OF EUROPE.

It is Denmark's belief that increased production is the only way to restore Europe after the war. Danish agriculture is prepared to take part in this task, and it has—as mentioned above in connection with those branches of production which are the corner-stones in agriculture—kept its capacity in effective order, although not unimpaired. Danish soil, which suffered much on account of the difficulty of importing artificial manures in 1918 and 1919, has now regained its former productive capacity. To this circumstance must be added as an invaluable advantage to Danish agriculture the comparatively quiet labour conditions prevailing in this industry. This is a consequence of a feature which is typical of the social structure characterizing Danish agriculture, i.e., the fact that work on the farms is undertaken to a considerable degree by the farmers' own children, whose term of service is very often only a link in the chain of their education, and one that prepares them for taking over their farms in due course. This is an invaluable advantage which lends Danish agriculture a stability and firmness in production, unmatched in any other industry.

Denmark has become famous for the uniformity and purity in the quality of its main lines of production—butter, bacon, eggs and in recent years cheese. The successful development of its agriculture has also tended to prevent that migration from the rural districts to the towns. The following figures bear striking testimony to this :—

The population of Denmark in 1921 was 3,267,831, of which 1,859,965 lived in the rural districts. This shows an increase of 145,578 over the previous five years, and of 209,615 in the ten years 1911–1921—the men and women about balance in the rural districts.

HOW THE HYGIENE OF THE NATION HAS BEEN AFFECTED.

Diseases that used to be very prevalent have disappeared, others are much reduced in their virulence. A striking instance is that of the Island of Lolland. At one time it was, owing to its low-lying character, subject to very serious floodings by the sea, leaving the soil very damp and boggy. This affected cultivation and produced also very unhealthy conditions, so much so that Marsh Fever (known over all Denmark as the Lolland fever), bronchitis and similar illnesses were very prevalent. These conditions continued until 1903, since when reclamation, drainage and afforestation schemes carried out on a big scale have resulted in modification of practically all these illnesses, and Marsh Fever has been eliminated. The soil is now one of the richest in Denmark.

TUBERCULOSIS OR—AS THE DANES CALL IT—ENGLISH SICKNESS.

In a recent report by the Danish National Society for Fighting Tuberculosis, satisfaction is expressed at the considerable decrease in the number of cases of tuberculosis in Denmark during the last generation, and Professor Faber, in submitting the report, said the tuberculosis mortality figures were now the lowest on record—50 per cent. less than those of 30 years ago—and were second only to those of Scotland, and he gave it as his view that in a few

years Scotland would be beaten. One of the Directors of the Society—Dr. Ostenfield—in speaking of the report, stated that 80 per cent. of the patients in the sanatoria for which they were responsible had been discharged during the year with positive results. The report states that a deficit of 1,293,474 kroner made on the sanatoria during the year was met by the State.

COTTON PRODUCTION AND CO-OPERATIVES.*

BY

A. H. STONE,

Vice-President, Staple Cotton Co-operative Association, Greenwood.

IN any comprehensive appraisal of recently developed agencies for the handling and distribution of Delta staples, we should also take account of antecedent economic conditions. In this regard, the outstanding feature of the whole history of tropical and semi-tropical large scale agricultural enterprise is the part played by the factorage system. The English factor, through the seventeenth and eighteenth centuries, bore substantially the same relationship to overseas agriculture and trade that the great banking institutions bear to modern industrial enterprise, if we do not push the analogy too far.

The operations of the system were essentially the same, regardless of crop or place. Before the end of the first quarter of the nineteenth century it had become inseparably identified with cotton production in the Southern States. Its predominant features remained the same. The factor invariably required the consignment of the entire crop, for the sale of which he charged a commission. The planter's basis of credit was usually fixed on baleage. On an advance of so many thousand dollars, so many bales of cotton were required to be shipped. A penalty commission was charged for every bale short of the contract number. There were various charges out of which the factor received a commission or rebate, such as storage, insurance, drayage, etc.

RESULTS OF SYSTEM.

The system had far-reaching economic results. It established one of the most vicious circles possible to any industry. Its emphasis being on baleage, there was every incentive to attempt the

* Reprinted from *The Textile World*, LXIII, No. 17.

impossible in production. The more land a planter was willing to buy on time, the more cotton he could promise, the more money he could borrow, the more slaves he could purchase. It was a business of unusual hazards, for both the factor and the planter. Fortunes were made and lost in it. It was also a business of peculiar fascinations, and many men of large ability engaged in it. It was a business in which social prestige might be enhanced by success, but was not diminished by failure. But the planting end of it was fundamentally unsound, taken as a whole, and Southern students would probably agree that it could not have survived the vicissitudes of many more years, even had there been no Civil War.

Another result was the concentration in a few important cities and towns of practically all of the fluid wealth of the cotton growing South. The interior country, which was practically the sole source of this wealth, was in a state of hopeless economic dependence on these urban centres. Speaking for our own territory, the Mississippi Delta, I may say that this condition of dependence was not relieved until the advent of the mortgage loan companies, about thirty years ago. Even then, there was only a swapping of horses, an exchange of one mortgage for another. But that step had to be taken before even the semblance of a new order could be established. The Delta was tributary to New Orleans, mainly, for sixty or seventy years. At a later date Memphis played an important part in its business life.

The two and a half decades after 1885 wrought very definite changes for the better, in all directions and along all lines. A pronounced aspect of this improved order of things was a change in the method of marketing cotton. And this was practically the first change in a hundred years, or since American cotton became a commercial crop.

Under the changed order, local factors still did a large volume of business, but under a somewhat modified system. Local buyers established themselves in every small town. Local banks were organized. Local compresses and warehouses were built. Rail-roads had made this possible. In short, the market had met the

producer half-way. The next step which followed this change was country buying. Under this it became possible for a planter to sell his crop at his own gin platform. I have referred to this as a change in the method of marketing. And it was not much more than this. The marketing system itself remained practically unaltered. The local factor could sell to the local buyer. Or the local buyer could deal direct with the grower. The grower might be present at every stage of these proceedings. And this change of situs, which made the transaction visible to the eye of the producer, was in reality the only change between marketing in one place and marketing in another excepting of course changes in certain charges, which did not at all affect the system. A psychological change, however, occurred gradually in the producer. Closer contact with buyers, closer connection with his crop after its production, unquestionably caused him to think more and more of the problems involved in converting his product into money, of the problems of marketing and of distribution. There was no longer the blind, unquestioning acceptance of a figure on an account of sale. He at least had an opportunity of knowing by name the man who bought his cotton, and of asking him why he could not pay more for it. He could even refuse to accept an offered price, although the only reason for his refusal was that he just felt that it was not enough.

NEED FOR REMEDIAL MEASURES.

The conditions under which we were attempting to conduct our business in 1920 were almost, if not quite, as unsound as was the system under which our fathers operated in 1860. In fact we, more than they, were out of joint with the progress of the time. There was, therefore, nothing unnatural, nothing revolutionary, nothing strained or artificial about the fact of our seeking remedial measures for a situation which we had come to realize was economically intolerable. I shall venture to suggest that any man who imagines that the means of relief which we finally agreed upon and endeavoured to apply, had no more substantial foundation than a mere effort to satisfy a lurking grudge; that the purpose was to put somebody out of business; that the ultimate end was to create a

monopoly and to reach out and grasp other branches of the cotton trade ; that any man who thinks this, or any part of it, has signally failed to apprehend the operation of one of the most elementary, but no less vital, laws of human existence, the instinct of self-preservation.

DETAILS OF ASSOCIATION.

There is neither mystery nor secrecy about the operations and affairs of the Staple Cotton Co-operative Association. It is in truth a very simple piece of machinery, for accomplishing a very simple purpose. It is composed entirely of *bonâ fide* growers of cotton. It handles only the cotton of its members. It acquires no cotton by purchase or trade. It is allowed to make no profit in its operations. It transacts no business other than such as is incidental to the selling of the cotton of its members. Title to the cotton it handles is vested in the Association. It operates within a well defined area. It is composed of some twenty-two hundred members. In management it is a highly centralized concern, all of its affairs being administered from one office. Its directorate is composed of twenty-one capable and experienced men, meeting monthly, throughout the year, and serving entirely without compensation. Four of these men are presidents of banks and eight others are bank officers or directors. Some of them are lawyers, and good ones. All of them are planters or owners of plantations. The active management of the Association is in the hands of men who devote their entire time exclusively to its affairs, and are paid for doing so. Its sales department is under the direction of a man whom we consider the ablest in the raw cotton end of the staple business. Its president is one of the most successful cotton planters in the South, and is the originator of the idea of a centralized marketing agency in this country. Its accounting department is one of the most efficiently organized and handled which it is possible for modern methods, technical skill and mechanical equipment to develop.

This Association does not seek to establish a monopoly of Delta cotton. It does not handle all of the Delta crop, by any

means. In all its transactions it seeks to observe the best traditions and practices of the trade. It attempts no radical innovations nor freakish experiments. It is controlled by business men, not by politicians. We attempt to secure results through adherence to the principles of established economic law, not by holding conventions and adopting resolutions. The Association seeks to emphasize the personal equation in all its transactions with the trade. It sells only from stocks actually in its own hands. It ships the cotton it sells. It sells for any reasonable period of delivery. It does not in any sense seek to control prices. Its management is not so foolish as to attempt so vain a thing. It tries by legitimate dealing and fair trading through the excellence of its service and the possession of superior facilities and large stocks, to obtain the best possible price for what it sells.

Such an organization as this can exist only through its ability to render service. And this service must include all those with whom it deals, those who buy as well as those for whom it sells.

NOT A HOLDING CORPORATION.

I would be less than frank if I did not express concern over the repeated statements that this Association is merely the tangible expression of the disposition and purpose of the grower to hold his cotton. No honest man likes to have his motives impugned and his assurances questioned. I cannot too strongly emphasize the fact that we are a selling concern. No man responsible for the conduct of this Association's affairs would tolerate for a moment a suggestion that we hold our cotton. We will not sell it all at any one time, nor to any one purchaser. Such a transaction would be repugnant to our conception of our legitimate function, as well as in direct contravention of our idea of orderly marketing. Our principle is to sell as steadily as possible, without dumping, in such manner as to dispose of one crop before another comes on. Unquestionably there are honest differences of opinion as to what constitutes orderly marketing. And we have no quarrel with the man who does not agree with us. There is no impropriety in suggesting that our financial connections include a Government agency and two of the

best known banking institutions in the country ; one eastern and one southern. Our arrangements are based on a policy of consistent selling, and our marketing methods have the unqualified approval of each of these three institutions.

IMPROVEMENT OVER OLD METHOD.

It may be asked, in view of all that I have said, " In what respect, then, is the Staple Association's system an improvement over the old method, in so far as the planter is concerned ? " The question is a fair one, and I shall conclude this discussion with a reply. In the first place the Association does receive a better average price for its cotton than is received for the average outside. This simply means that our policy of consistent, steady selling, day in and day out, month by month, throughout the season, secures better average returns than come from selling by fits and starts, spasmodically and unsystematically. We are justified in this conclusion, not only by our private advices and information, but by comparing our prices with those reported for our territory by the Bureau of Markets. A recent issue of a leading New England journal spoke of the large number of odd lots of fifty to two hundred sales of staples which were being picked up here and there at cents a pound under Association prices. This is absolutely legitimate trading, but we do not sell our cotton that way. All such sales unfavourably affect the average outside price while being of doubtful value as purchases to anyone except the individual buyer who made the pick-up.

Another important service to the grower, without cost to anybody, is rendered through the Association's financial arrangements. The Association supplements the aid of the local bank, to the end that " distressed cotton " is a thing of the past, in so far as our members are concerned.

Under the old system the grower has always felt that he had a just ground of complaint in the matter of samples and loose. He has felt that his cotton was unfairly dealt with, that it was sampled more than was necessary, that too much loose was accumulated from it, and that the whole process was wasteful and unjust. From time

immemorial he has been assured that his complaint was groundless, or at least that he greatly exaggerated the results of these practices. During the Staple Association's first season it received 157,865 bales of cotton. Every effort was made to reduce waste to a minimum, and each bale was sampled but one time. Yet the accumulated samples and loose from our cotton, handled in this way, amounted to 256 bales. It would be interesting to know just what the aggregate loss to the grower amounts to on the entire American crop, on this one item alone. For it must be borne in mind that every penny of the savings on the various items which I have mentioned represents, or is equivalent to, a loss to the grower under any other system. Let me give you one other illustration, before I close. The Association makes an expense deduction, in selling the cotton of its members, of three per cent. of the sales price. When we began operations it was predicted by our friends outside that we would never operate under this, but would have to make additional deductions or assessments. We are reputed to have the best-paid cotton men in America at the head of our sales department. Possibly this is true. We are charged with having an expensively organized business. This is not true. But be this as it may, at the close of our first season's operations, instead of calling on our members for additional expense money, we refunded to them in cash nearly \$300,000, an amount equivalent to exactly one-half of our original three per cent. deduction.

The man, therefore, who imagines that our success depends upon the elimination of middlemen, or that the only saving to the grower which such an organization can accomplish is the middleman's profit, knows very little about the inner operations of the Staple Cotton Association. We are not trying to eliminate the middleman. On the contrary, we like him, and do business with him every day.

Notes

THE BOARD OF AGRICULTURE IN INDIA.

THE Thirteenth Meeting of the Board of Agriculture in India will be held at Bangalore from the 21st to the 26th January, 1924, when the following subjects will be discussed :—

- (1) To review the progress made in non-credit agricultural co-operation in India and to consider ways and means of stimulating further progress.
- (2) To examine the curriculum of the Imperial Institute of Animal Husbandry and Dairying at Bangalore and to consider the best means of co-operating with Provincial Governments and Indian States with a view to utilizing this Institute to the best advantage.
- (3) To consider the best means of utilizing the Pusa, Bangalore, Wellington and Karnal dairy and cattle-breeding farms for the good of India as a whole.
- (4) To review the steps being taken by Provincial Governments and Indian States for the improvement of cattle by better breeding and feeding and to make recommendations.
- (5) To consider the steps taken to give effect to the recommendations of the Board of Agriculture of 1919 (Subject IV) for the improvement of—
 - (a) forecasts,
 - (b) final statistics of the area and yield of cotton in India.
- (6) To consider the progress made in giving effect to the recommendations of the Indian Cotton Committee for 1917-18 with special reference to—
 - (a) the work of the Central Cotton Committee,

- (b) the recommendations of the Board of Agriculture of 1919 in regard to cotton marketing.
- (7) Is it possible and desirable to make Government farms, including experimental, cattle-breeding, seed and demonstration farms, pay ?
- (8) To review the progress made in popularising the use of improved agricultural implements and power machinery in India with special reference to—
- (a) the provision of facilities for sale, hire and repair,
 - (b) propaganda,
 - (c) the designing and testing of implements.
- (9) The utilization of indigenous supplies of phosphates.
- (10) To consider the steps taken to give effect to the recommendations of the Indian Sugar Committee with special reference to those relating to the Coimbatore Cane-breeding Station.
- (11) The desirability of bringing waste lands under cultivation with a view to increasing the production of food grains.

* * *

A NEW SPRING-TOOTH HARROW.

OF the steel agricultural implements which have been introduced to India in the past 15 years, the spring-tooth harrow is perhaps one of the most popular. At the Peshawar Agricultural Station it is the most useful implement next to the Rajah plough. After the land has been turned over, planked and rolled, the five-tooth harrow drawn by a pair of good oxen is used in place of the country plough, and it satisfactorily treats four times as much land as the latter implement in a day's work. In the orchard the harrow is also useful ; but as it cannot be controlled and directed by the ploughman, it is liable to bark the trees.

A new five-tooth-spring-tined harrow has recently been imported from Australia which has stilts and a guiding fore-wheel. This implement can be controlled and directed with ease and accuracy,

and it may even be used to intercultivate crops which are planted in lines 3 to 4 feet asunder. On fallow land the implement does as much work and does this as efficiently as the old type of harrow. At the same time it is far lighter in draught than the spring-tooth harrow which has neither stilts nor fore-wheel.



The Nobelius spring-tooth cultivator.

Without any real exertion the ploughman can lighten the draught to the oxen on difficult patches of land and turn the harrow with ease on the head-lands. Altogether the implement which is called the Nobelius cultivator is a distinct improvement on the old spring-tined harrow. [W. ROBERTSON BROWN.]

* * *

ROOT PRUNING OF THE MANGO PLANT.

IT is generally believed that the mango plant does not bear root pruning which, if performed, either kills it or makes its growth stunted. This might be true in the case of big trees, but from my own experience I can say that mango seedlings from two to three years of age withstand close root pruning as any other plant generally does. I have seen little difference between the growth made by a pot grown plant transplanted to the field with all its cramped and tangled roots and that made by a plant raised on

the ground and subsequently transferred to another place after close root pruning.

It is an undoubted advantage that the mango grown *in situ* has a very deep reaching tap root and makes a vast spread. It does not require much irrigation. But in every case it is not very convenient to grow plants *in situ*, especially when one requires grafted plants for the garden. In such circumstances there does not appear to be much good in propagating seedlings in pots where they do not make a fair growth. The stock is unnecessarily dwarfed.

It was in the beginning of the monsoon of the year 1918 that I wanted some mango grafts for my own garden. I decided to take the grafts from the trees belonging to a relative of mine living at 20 miles from my place. I had mango seedlings two to three years old. To my great annoyance I found that my *mali* had not moved these seedlings during the period of their growth on the spot where they had been planted while only two or three weeks old. So from two to three years they had been left in the same position without being disturbed. When a few plants were taken out, the tap root was found to have gone deeper than a foot or 18 inches. These plants had to be taken out with a big quantity of earth and any attempt to accommodate them in medium sized pots involved extensive root pruning and the attendant risk of killing the plants outright. No young seedlings were available in the vicinity. I had to hasten the despatch of plants as the roads were *kacha* and heavy rains would have made it extremely difficult for the bullock cart to move.

What I did was to put the plants in pots after pruning away much of their roots. Then their leaves and young shoots were clipped off—two or three leaves being left on each plant. The plants were kept in a dark and cool place where there was enough ventilation. For three or four days water was sprinkled over the plants thrice a day. This moistening was slowly stopped and the plants were gradually made accustomed to exposure. On the tenth day they were able to bear the midday sun of the month of July. They were despatched for grafting on the fifteenth day. Out of 56 seedlings thus taken out 45 survived.

Enarch-grafting was done on all the plants. A single matured shoot was used as the scion in each case.

Just after a month I had to meet another obstacle. The parent mango trees were only a few furlongs away from the Ganges. Floods threatened, and as all the seedlings in the pots were on the ground, the grafts had to be removed early to avoid submersion.

As was expected, some of the scions showed signs of withering only after a few hours of their removal from the parent trees. Their leaves were reduced to two or three only and they were given the same treatment as the seedling stocks had received after removal from the ground to the pots. In 10 days fresh buds appeared on the scions and they were gradually made accustomed to the full exposure of the sun. This took another 10 days. Then they were taken back to my garden where they were planted on the third day of their arrival.

Grafting was performed on 45 plants of which only 32 survived. The dead plants were examined and the failure was mostly due to the rain water having found its way through the grafting clay. The cut surfaces were infested with fungoids and ants.

Of these 32 grafts, I have at present 27 trees alive. They have made as much growth as pot grown grafts. Both have been equally irrigated. It is too early to determine anything further about the two classes of grafted trees. There seems to be no difference in their fruiting capacity.

Subsequently I have found that the loss can be minimised to a very great extent with some care and patience.

The advantages of this method are :—

- (1) The pot grown plants are stunted and require constant supply of water and care. The stock grown on the ground makes a full growth and requires less care and watering. The stock from the pot grown plant is not very strong and robust.
- (2) When transferring a pot grown plant to the ground, one has to plant it with all its injured and cramped roots. The plants which have their roots pruned make a

fresh growth of roots and restart growing with a new vigour.

- (3) The whole time required for preparing a graft fit for plantation is only about nine weeks, and during this short period one gets quite a big and hardy grafted mango plant. Under the ordinary system the time and labour required are unnecessarily long and heavy. [RAJ KISHORE SINGH.]

* * *

CAUSE AND CONTROL OF FIJI DISEASE OF SUGARCANE.

FIJI disease has long been listed as one of the diseases the cause of which is unknown. Recent work done in the Department of Plant Pathology, at the College of Agriculture, Los Banos,¹ has demonstrated a very probable cause. Since the paper describing the cause is very technical, this article is now being presented to make the results more available to the sugar-growing public.

Any one familiar with Fiji disease in the field knows that the character by which it may be certainly recognized is the presence of galls on the leaves. These galls are generally hard, raised places along the veins which appear as tiny, raised, white spots on the young leaves and as yellow or brown ones on the old leaves. They distinguish Fiji disease from all other diseases of cane. Insect and fungus pests produce galls in many plants. In such cases the pest—fungus or insect—lives in the galls, so in the case of Fiji diseased cane one would naturally search in the galls for the cause of the disease.

The galls are composed of cells like those making up the pith of the cane except that the gall cells have thickened walls. Every typical plant cell contains a central body called the nucleus and a liquid in which float the food making and storing organs of the cell. With a good microscope one can see in cells of Fiji galls bodies which are not present in ordinary plant cells or in the cells of healthy cane. These bodies, when taken out of the gall cells and placed in cane

¹ McWhorter, F. P. The nature of the organism found in Fiji galls of sugarcane. *Phil. Agri.*, XI, 103-111, 1922.

juice, will liven up and develop at once into active organisms known as amœbæ, thereby showing that they are not merely some inert substance present in the cells and developed by the disease, but foreign organisms living in the cane cells. A study of their life-history showed them to be amœbæ and that the stage common in old gall cells was the resting stage known as cysts. Amœbæ are small, single-celled animals that are able to move from place to place by means of jelly-like protrusions from their own bodies. Whereas these amœbæ are entirely absent in healthy cane and are most abundant in the gall cells of Fiji diseased cane, it is thought that they are the cause of Fiji disease. It is hoped that work, which is now in progress at the College, will conclusively demonstrate whether or not this is actually the case. Amœbæ cause many animal diseases, notably dysentery in man, but most plant diseases are due either to bacteria or fungi. The amœba thought to cause Fiji disease is so small that it must be magnified several hundred times to make it visible, but it is much larger than disease causing bacteria; it would take about 50 bacteria to equal one medium-sized Fiji amœba.

It is generally thought among sugar men that Fiji disease is not carried through the soil; hence it is considered safe to plant cane after cane in a Fiji infested field. The writer has demonstrated the amœbæ in the roots of badly diseased cane, and therefore wonders if some of the disease generally attributed to bad seed and probably insect transmission is not due after all to soil transmission.

The work of Lee and others has very definitely proved that the planting of sets from diseased cane is certain to give rise to diseased cane. Those wishing an excellent statement of this fact should read Lee's article in the "Plant pest and disease number" of the *Philippine Agricultural Review* for 1922. Also we have demonstrated this fact several times here in our experimental plots. The fact that healthy sets must be planted in order to get healthy plants must be the starting point in controlling the disease. To this generally accepted fact the writer wished to add another, which he feels his experience during the past year more than justifies.

Namely, *it is unsafe to select sets from any part of a field if Fiji is present in the field.* That is, it is dangerous to select sets from apparently healthy plants in a field wherein the disease is occurring. This is especially dangerous if the sets are being taken from ratoon stands. The disease may be latent in the old cane and appear at once in the seedling.

Another thing that we have recently demonstrated at the College is the effect of excess water on diseased plants. Plants which had almost died of the disease when growing in field conditions frequently took on new growth and almost recovered when transplanted to saturated soil. Perhaps irrigation will render plants less susceptible to the disease.

Certain varieties of cane are unquestionably less susceptible to the disease than others. The writer does not believe sufficient careful experimental or field work has been done on this subject to, as yet, justify any definite statement as to what are the resistant Philippine varieties.

In regard to controlling the disease it cannot be too strongly emphasized that one should plant healthy sets taken from field *in which there is no Fiji disease.* [FRANK P. MCWHORTER in *Sugar News*, IV, No. 8.]

*
* *

NEED FOR FRESH COTTON FIELDS.

AN instructive lecture was delivered at the Textile Institute, Manchester, by Mr. Walter R. Dunlop, Professor of Economics at the West Indian Agricultural College, on "Cotton and some of its Problems." Mr. Myers, Chairman of the Lancashire Section of the Institute, occupied the chair.

The lecturer, in giving a brief history of the cotton supply in this country, said the enormous industry of this country and the world was essentially a nineteenth century development, extending from the French Revolution in 1798 to the outbreak of the European War in 1914. Up to the French Revolution France was the coming cotton country, but the Revolution brought as its material penalty a set-back to French industrialism, which took at least ten years to recover. Britain diverted the supply of cotton to this country.

Regarding the present position of world production and consumption, Professor Dunlop said that during the last 25 years the consumption had been increasing at a greater rate than production. It was due to the increasing manufacturing demand of the United States, Canada, Japan and India, and to a reduction in the acreage yield in America and Egypt. The decrease in Egypt per feddan had been due to poorer lands being brought under cultivation, bad drainage, and insect pests like the pink boll-worm, the latter being the main factor. In the United States during the last ten years it was due to the spread of the boll-weevil and labour shortage. In new areas the pink boll-worm was the most serious insect pest. The boll-weevil was confined entirely to America, whereas the pink boll-worm was world-wide in its distribution.

Discussing the United States crop, the lecturer said that perhaps the most serious feature was the tendency to violent fluctuations due to the reaction of prices on area planted, the weather damage during prolonged picking periods, and the notoriously speculative character of the crop. Mixed farming also made regulation of the cotton area economically easy, while high labour costs did not make it attractive or even possible at pre-war prices. Furthermore, conditions in the United States were not conducive to the preservation of uniformity and of quality—a very important matter for Lancashire. There had been deterioration in quality as well as quantity due to longer picking periods, inefficient baling and compressing, and insect pests. To indicate the immediate position, in the season 1921-22 the world's crop was 15 million bales and the world's consumption nearly $21\frac{1}{4}$ million bales, of which nearly 13 million bales was consumed in the United States. This implied the absorption of the carry-over, or post-seasonal stock, and was obviously serious. The position at present was that trade would not revive sufficiently to make the supply of cotton a serious matter for some years. The present need for expanding and stabilizing the production of cotton in the near future was obvious, and it was a matter the urgency of which had long been recognized. The work of the British Cotton Growing Association had led to excellent results, and it was also being taken up by the Empire

Cotton Growing Corporation with the assistance of the spinners, and they would by means of the Corporation be able to provide more scientifically trained men in new areas. The Sudan, India, East and West Africa and Queensland were being given increasing opportunities to expand.

The department with which he had been connected in the West Indies had tried to re-establish Sea Islands cotton round about 1897, and it took many years, with great difficulty and perseverance, before that industry could be properly established. Now, through lack of demand for finer cottons, the existence of the industry was jeopardized. They had to be very careful or it might deteriorate, and possibly disappear.

The expansion of cotton into new regions of the empire was no easy task. This was a matter which might not interest them directly, but he thought it was extremely advisable for people in Lancashire to be familiar with what was happening and what they were trying to do at the production end. It was evident in regard to these problems the difficulties which would arise were temperature, water, labour, supply, transport and finance. It was to be hoped that no scheme would be attempted unless these matters were present and could be provided for. They were obviously essential in these regions and demanded the employment of men of ability.

In regard to pests in new areas, from the standpoint of American production the boll-weevil was by far the most serious pest; but it was the pink boll-worm which was the most menacing pest in new areas. The distribution of the pink boll-worm gave cause for considerable anxiety, but the boll-weevil was entirely confined to the United States and tropical America, whereas the pink boll-worm had a world distribution, which was an important point in regard to sending cotton into new areas.

The development of cotton in new areas required a study of human nature, economic subjects in general, as well as a study of natural scientific conditions. Cotton was grown by coloured labour largely. At present, as Mr. Himbury showed, cotton cultivation was between 17 degrees north of the equator and 15 degrees south, and the production of cotton would not only be largely dependent

on coloured labour but also on coloured management. All this meant that scientific organization and study of man in relation to cotton would be as necessary as the study of cotton in relation to man.

In developing the empire's cotton fields in the future it would be necessary to have economic research. By economic research he meant investigation into the problems and difficulties along lines that came under the studies of the various schools of economics and conducted along practical lines, and accurate costing would be necessary. The study of marketing was very important in other forms of raw material. He was advocating industrializing cotton, to put it on the same organized scale as the intermediate manufacturing industries through which the raw material went before it reached the consumer in the form of goods. It required broad thinking. From the spinner, even from the consumer, to the cotton grower there must be one continuous line of organized contact—a cotton industry to embrace production, manufacture, and distribution. Research and ingenuity in this country must be unremittingly applied to keep up and extend the demand.

At the growers' end psycho-economic science, as well as natural science, would be wanted. The conception of tropical labour as a herd of human energy to be exploited was archaic. A feature of cotton growing was that it was increasingly becoming the occupation of the smaller peasant proprietors. In any case, even with ordinary wage earners, motion studies, reduction of fatigue and possibly vocational selection were necessary. The object was to save time, reduce fatigue, strengthen efficiency and lessen the cost of production. These were only some of the possible applications of psycho-economics. One could mention further the statistical (mathematical) study of the cost of living, market prices of cotton and production costs in different countries and the complex and important problems of price reactions on production in different areas. Accurate costing was essential, especially when there was rotation of crops, and systematised methods should be introduced in order to avoid, for instance, the inclusion of interest on capital as a costing charge as had been done recently in Texas. Accurate

costing could be done. It had been done by the rubber industry, which produced perhaps the best costing figures of any industry growing raw material in tropical countries. On the other hand, in certain districts where cotton was grown in rotation with other crops, he did not think any one really knew the cost of its production.

But in the long run the ultimate success of establishing new and large areas would depend upon a rational combination of interests. There ought to be closer economic contact between the manufacturing and the producing end. If the new areas were to be established, it was up to manufacturers, spinners and even consumers to do what they could to stabilize prices and stimulate the demand, especially for the finer kinds. A good example of the tendency to organize an industry right through from the production of the raw material to the manufacturing was seen in connection with rubber. Something like the general organization that was there being attempted should be done in relation to cotton. If some of the lines of development he had suggested were followed, by the end of the twentieth century the supply of cotton would be satisfactory, and the industry as a whole would be not merely one of the greatest imperial industries but one of the greatest of imperial achievements. [*The Textile Mercury*, XVIII, No. 1786.]

* * *

CEARA COTTON.

CEARA is a State situated in the north-eastern portion of Brazil covering an area of 160,987 sq. km. (almost the size of Italy) which has produced cotton for many years, though the quantity grown has so far been on a small scale, some 150,000 bales of 300 lb. every year, but extensive irrigation works which are in course of construction promise to make Ceara a regular supplier of medium staple cotton ($1\frac{1}{8}$ to $1\frac{3}{8}$ in.) of some importance. Some parts of the State are indeed able to grow long staple cotton. The main reason why Ceara cotton is sold in Europe below the price of similar cotton is that the cultivators have hitherto grown four or five different kinds of seeds in one and the same field and have paid little attention to the grade; unfortunately the export merchants have not

sufficiently encouraged the few who sold them a uniform and clean cotton.

This state of affairs is now being remedied. On the strength of recommendations made by the writer to the Government of the State of Ceara and to the Federal Government three large cotton seed farms are being established as a start in the principal districts, where only one variety of seed will be grown, so that a mixture of various strains will finally become next to impossible. In most of the districts tree cottons are planted, though in some parts which are subject to floods the annual American kind is grown.

The merchants of Ceara are also organizing themselves to bring about a more up-to-date method of handling cotton. [A. S. PEARSE in *Int. Cotton Bull.*, No. 3, 1923.]

*
* *

COTTON RESEARCH.

THROUGH the courtesy of the British Cotton Industry Research Association, the Secretary of the Indian Central Cotton Committee has sent the following abstracts for publication :—

MICROMETRIC SLIDE RULE.

A nomograph is engraved on a xylonite strip by means of which microscopic measurements can be obtained with any combination of objective, eyepiece, etc., after a single calibration. A second nomograph on the back permits of making corrections for alterations in the length of the microscope tube. [*Jour. Roy. Micro. Soc.*, 1923, pp. 57-61. H. J. DENHAM.]

SPINNING TEST OF AMERICAN COTTON.

Comparative spinning tests of the following cottons from the crop of 1921, grown under boll-weevil conditions, have been made : Acala, Lone Star, Mexican Big Boll, Rowden, and a typical cotton of the kind commercially known as "North Georgia." All the cottons were tested under identical mechanical conditions. The grades, lengths of staple, percentages of visible waste, strength of the yarns and percentages of average deviation or irregularity of the sizings and strengths indicate that for hard twisted or warp

yarns the varieties tested, if placed in order of their merit from a spinner's point of view, would fall as follows: (1) Acala and Mexican Big Boll, equal; (2) Lone Star and Rowden, equal; (3) Typical North Georgia. [*U. S. Dept. Agri. Bull.* 1148, 1923, 6 pp. W. R. MEADOWS.]

COTTON STAPLE TEST.

Several new methods of obtaining mean staple lengths and staple diagrams are described: (1) This method is practically the same as that of the Baer sorter. (2) A sliver, in which the hairs are thoroughly mixed and parallel to one another, is gripped along a line perpendicular to its length. The loose hairs are combed out and the sliver cut along the line of grip. The tuft so obtained is weighed. It is shown (on the assumption that the mass of a hair is on the average proportional to its length) that the mean staple length is 2 N.c.g. ; where N.c. = the length per unit mass of the sliver and g. = the mass of the tuft. (3) A sliver is gripped as in (2) and the loose hairs combed out on both sides of the grip. The hairs remaining are rearranged so that the extremities of the hairs are in line. The thickness of this tuft is measured at different positions along its length, by means of an apparatus described in the paper. (4) The procedure is the same as (3) except that the hairs in the tuft are not rearranged, and only one side of the tuft is used. (5) The same as (4); but instead of measuring the thickness of the tuft, the tuft is cut into sections, which are afterwards weighed. Several methods are given for reducing the results of (3), (4) and (5) to the ordinary staple diagram, and for obtaining the mean staple length. [*L'Ind. Text.*, 1923, 39, 156-162. H. FLUHR.]

FIELD PLOTS.

The control of experimental error in nursery trials has been studied and it is shown that the yielding ability of selections or crosses as grown in small individually planted plots is of little value as an indication of the comparative yielding ability of the separate selections. The rod-row method is in general use as a means of obtaining preliminary yielding tests of new plant breeding

productions. As a result of field experiments it appears that three row plots, each row being approximately 16 ft. in length, and the use of only the central row in the yield test is a desirable plan. Replication, in general, reduces the probable error according to mathematical expectation. Four systematically distributed plots are suggested for each variety in the trial. The probable error may be calculated from the deviation from the mean of the variety method. It has about the same relative magnitude as that obtained from computing the probable error from the check plot method. If the test in rod row trials is conducted properly the use of the calculated probable error, as a means of determining the reliability or significance of any particular strain comparison, is justified both from the mathematical and practical standpoints. [*Jour. Amer. Soc. Agronomy*, 1923, 15, 177-192. H. K. HAYES.]

The following are the results of a study of replication in relation to accuracy in comparative crop tests. In all the tests made large plots were found to be more accurate than small plots. The mean percentage ranged from 2.31 with wheat plots 0.032 acre in size to 7.86 with oat plots 0.0016 acre in size. An increase in the length of plot has greater influence on decreasing the error than has an increase in width. Replication is much more effective in reducing error than is a change in either the size or shape of plots. If land is limited the frequent replication of small plots is a more efficient means of obtaining a high degree of accuracy than is the use of the same amount of land with less frequently replicated larger plots. Within the limits of the size and shapes of plots, and number of replications used in the experiments described it does not seem possible to reduce the probable error below 2 per cent. and to measure differences in yield of less than 6 per cent. with certainty unless eight to sixteen replications are made. [*Jour. Amer. Soc. Agronomy*, 1923, 15, 192-199. R. SUMMERBY.]

HISTORICAL ACCOUNT OF COTTON.

References to the early literature regarding cotton are given from the inscriptions of Senacherib and Theophrastus. Philological

evidence is presented that cotton originated in Assyria and India and that it was not introduced into Egypt or Europe until the Arabic conquest. The author regards the statements in Pliny, other than those copied from Theophrastus, as largely interpolations of a much later date. The author suggests that if the accounts of Columbus and the early explorers are correct, *Bombax ceiba* rather than *Gossypium* was the plant meant by "cotton." Since Columbus brought seeds of a number of plants on his second voyage, it is probable that he imported cotton, a crop perhaps new to the Indians since they were so reluctant to cultivate it. Most of the native cloth was made from the maguey. Cotton culture in Mexico is discussed in detail with a survey of all available references in 16th century literature. With regard to Peru, it is suggested that cotton was introduced at the conquest by the negro overseers. Evidence is given that the presence of cotton in graves is no safe criterion of its antiquity. [*Bot Abstr.*, 1923, 12, 268; from "Africa and the Discovery of America," Vol. II, 1922. L. WIENER.]

**PERSONAL NOTES, APPOINTMENTS AND TRANSFERS,
MEETINGS AND CONFERENCES, ETC.**

MR. GIRJA SHANKER BAJPAI, C.B.E., I.C.S. (United Provinces), has been appointed Under Secretary to the Government of India in the Department of Education, Health and Lands from 3rd September, 1923.

* * *

MR. D. BALAKRISHNA MURTI, on return from leave, has been posted as Professor of Agriculture and Superintendent, Central Farm, Coimbatore.

* * *

MR. P. H. RAMA REDDI, M.A., B.Sc., on relief by Mr. D. Balakrishna Murti, has been appointed Deputy Director of Agriculture, III Circle, Madras.

* * *

MR. D. A. D. AITCHISON, M.R.C.V.S., Principal, Madras Veterinary College, has been placed in charge of the current duties of the office of the Chief Superintendent, Civil Veterinary Department, Madras, in addition to his own duties, during the absence of Mr. F. Ware on combined leave for one year from 1st October, 1923.

* * *

MR. T. F. MAIN, B.Sc., Deputy Director of Agriculture, Sind, has been granted combined leave for ten months from the date of relief by Mr. T. Gilbert.

* * *

MR. ABDUL RAHMAN MALIK has been appointed to act as Deputy Director of Agriculture, Eastern Circle, Bengal, from 21st July, 1923, *vice* Mr. K. McLean appointed to officiate as Fibre Expert to the Government of Bengal.

MR. H. W. STEWART, Agricultural Engineer, Bihar and Orissa, has been granted leave on average pay for nine days from 26th October, 1923.

* * *

CAPTAIN P. B. RILEY, Deputy Director, North Bihar Range, has been confirmed in his appointment in the Indian Veterinary Service from 21st March, 1923.

* * *

DR. H. M. LEAKE, M.A., Sc.D., Director of Agriculture, United Provinces, has been placed temporarily on foreign service under the Government of the Sudan, from 9th October, 1923, or subsequent date.

* * *

THE services of MR. O. T. FAULKNER, B.A., Deputy Director of Agriculture, Punjab, have been transferred permanently to the Nigerian Service from 15th June, 1921.

* * *

MR. T. A. MILLER BROWNLIE, Agricultural Engineer to Government, Lyallpur, has been appointed to officiate as Principal, Punjab Agricultural College, *vice* Mr. D. Milne, acting as Director of Agriculture, Punjab.

* * *

RAI SAHIB LALA JAI CHAND LUTHRA has been promoted to the Indian Agricultural Service and appointed Associate Professor of Botany, Punjab Agricultural College, Lyallpur, from 27th August, 1923.

* * *

HAVING finished his work in the Punjab Irrigation Department, SARDAR SAHIB KHARAK SINGH, M.A., resumed charge of his duties as Associate Professor of Agriculture in the Punjab Agricultural College, Lyallpur, on 19th July, 1923.

MR. T. J. EGAN, M.R.C.V.S., Assistant Superintendent Government Cattle Farm, Hissar, was on one month's leave on average pay from 24th August, 1923.

* * *

THE services of MR. R. T. PEARL, B.Sc., A.R.C.S., as Mycologist to the Government of Central Provinces will terminate after 30th November, 1923, on the expiry of the combined leave granted to him.

* * *

MR. S. T. D. WALLACE, V.C., B.Sc., Officiating Deputy Director of Agriculture in charge of Animal Husbandry, Central Provinces, has been confirmed in his appointment in the Indian Agricultural Service from 25th April, 1923.

* * *

MR. C. W. WILSON, M.R.C.V.S., Superintendent, Civil Veterinary Department and Veterinary Adviser to Government, Central Provinces, has been granted combined leave for one year from 1st November, 1923, Mr. R. F. Stirling officiating.

* * *

MR. LESLIE LORD, B.A., Deputy Director of Agriculture, Northern Circle, Burma, has been granted leave on average pay for seven months from 9th September, 1923.

* * *

MR. W. GREGSON, Deputy Director of Agriculture, Burma, has been transferred from Myingyan and posted to duty with headquarters at Mandalay from 1st September, 1923.

* * *

CAPTAIN A. O'NEILL, Civil Veterinary Department, Burma the termination of whose services has been sanctioned by the Secretary of State for India, was relieved of his duties on 2nd July, 1923.

Reviews

The Science and Practice of Coconut Cultivation.—By H. C. SAMPSON, C.I.E., B.Sc. (London : John Bale Sons and Danielsson, Ltd.) Price, 31s. 6d.

MR. SAMPSON'S long expected book on the coconut palm has been published, and it is a valuable addition to the scanty literature that exists on this important commercial crop. The coconut palm is cultivated largely on the West Coast of India, and especially in the Native States of Travancore and Cochin and in the Malabar District of the Madras Presidency. Mr. Sampson's connection with the Madras Agricultural Department, first as Deputy Director and later on as Director of Agriculture, gave him ample opportunity to study the problems connected with coconut cultivation. He collected a mass of useful information about local practices and methods and conducted his own experiments and investigations at the coconut stations recently started by the Madras Agricultural Department. All this information and results of his experiments and investigations are embodied in the book under review. It is divided into three parts: the first dealing with the morphology of the coconut palm, the second with the planting and management of the plantation, and the third with the manufacture of coconut products.

The most important chapter in Part I is that which deals with the root system. The study of the root system of the coconut palm has been neglected so far, and it is very creditable that Mr. Sampson recognized the importance of this subject and made a careful and detailed study of it. The effect of drainage and aeration of soil on the development of roots and the necessity for the removal of the dead rootlets and for the maintenance of a soil mulch by frequent cultivation have been well brought out by the author. It is a common belief among cultivators that the seed

nuts from trees growing on the seacoast should not be used for planting in the interior parts. Mr. Sampson gives a rational explanation for this belief on page 3 of his book. He says: "Some trees will send their roots obliquely into the soil, while in others the greater number of roots will grow in a much more horizontal direction. In all probability it is for this reason that the practice has arisen to obtain seed nuts from trees grown under similar soil conditions to those on the area required to be planted up." The variations in the root system caused by good or bad drainage, the influence of the permanent stagnant water table on the growth and productiveness of the tree, the difference between "feeding roots" which grow more or less horizontally on the surface, and the "water roots" which grow downwards till they reach the water table, the drought resisting power and the high yielding capacity of trees with deep water roots, these and other observations based on a study of the root system will prove highly beneficial to any practical coconut cultivator.

In the remaining chapters of Part I, the author describes the stem, the crown, the leaf, the flower, the fruit, the germination of the seed and the development of the seedlings. The description is interesting from the scientific and the practical point of view. The hints contained in these chapters for the identification of good trees from which seed nuts are to be selected are of special interest to all prospective coconut cultivators. A regular and heavy yielding tree can be recognized from the leaf scars on the stem, which will be deep and close together. Again, the crown of such a tree will be compact, the leaves being close together, and it may contain as many as 35 to 40 leaves. The leaf-stalks should be short and thick with wide leaflets. Trees having long and slender leaf-stalks with narrow leaflets should be avoided. The fruit stalks should similarly be short and thick. Seed nuts selected from such trees are the best for planting. Proper attention is not being paid to these points at present. It must be remembered that the coconut is a long standing tree. Its age may go up to 100 years and more under favourable conditions. The evil effect of any mistake made in the selection of the seed nut will last throughout the life-time

of the tree, and hence the importance of bestowing the greatest care on the selection of seed nuts cannot sufficiently be emphasized.

In Part II which deals with the planting of coconut seedlings and the subsequent management of the plantation, the author makes many useful suggestions in regard to the selection of the site, the quality of the land suited to coconut cultivation, the raising of seedlings in the nursery, the method of planting and the distance at which seedlings are to be planted, the application of manure, the cultivation of cover crops, etc. In regard to the method of planting the author deprecates deep planting which is practised on the Malabar Coast. Deep planting is not practised on all kinds of soils. Only on elevated laterite lands exposed to the wind is this practice adopted, and from general experience it is found that on such lands deep planting has distinct advantages.

In Part II the chapter which should attract the prominent attention of the reader is the one dealing with manuring. From the numerous analyses of the different parts of the tree conducted at different stages, which are given in tabular forms in this chapter, one can easily find out the food requirements of the tree at each stage and adopt a rational and economic system of manuring suited to such requirements. Coconut is a crop which responds readily to the application of manure. Trees which yield on an average 25 or 30 nuts per annum can be made to yield double that number and even more by a proper system of manuring. At present very little manuring is being done on the Malabar Coast, and the little that is done is not based on any scientific principle. There is considerable scope, therefore, for the development and improvement of the method of manuring. Mr. Sampson has only touched upon the fringe of this complicated problem of manuring the coconut palm, but he has opened out the way for further investigations and experiments and indicated the lines along which the work should be carried on. This in itself is of great value.

Part III deals with the manufacture of copra, coconut oil and other products. The ordinary methods that are practised in coconut growing areas are described and they do not call for any special remarks.

One noticeable drawback of the book is the absence of a chapter dealing with diseases and pests. Coconut is subject to the attack of very many serious diseases and pests and a great deal of original work has been done on them in Ceylon. The Rhinoceros beetle, the Red weevil and *Nephantis serinopa* are some of the serious pests, and the root disease, the bud-rot and the stem bleeding disease are the most important fungoid diseases of the coconut palm on the Malabar Coast. A description of these pests and diseases and of the remedial and preventive measures so far known, would have added considerably to the usefulness of the book. It should also be noted with regret that the question of the nut fall has not been fully dealt with in the book. Nut fall may be caused by the attack of fungus, or by the non-fertilization of ovules or by alterations in the physiological condition of the tree brought about by water stagnation in the soil and defective aeration. Practical coconut cultivators would have welcomed a description of these causes, the circumstances under which they occur and the measures to be adopted for remedying them.

In spite of these drawbacks which, it is hoped, will be removed in a subsequent edition, the book on the whole is a creditable production, and it should find a place in the home of every present and prospective cultivator of the *Kalpa Vriksham* (The Tree of Life) of Kerala. [N. K. P.]

*
* *

Kalide Murghi Khana (in Urdu) : Key to Poultry Keeping.—
By TAHIR H. QURASHY, B.Sc., Late Farm Manager, U. P. Poultry Association. Pp. 258. Illustrated. Price, Rs. 3.

THE activities of the U. P. Poultry Association, under the able guidance of Mrs. A. K. Fawkes, have created wide interest in poultry breeding in Northern India, and the publication of this manual will to some extent meet the requirements of a large class of people to whom books written in English are of little use. It is planned on a more ambitious scale than Mrs. Fawkes' brochure on "Murghion ka rakh-rakhaw" and deals briefly but adequately with all aspects of poultry keeping, but it cannot

be said that the author has succeeded in making clear the principles of Mendelism to the class of readers for which it is intended. In chapters dealing with the selection and breeding of fowls, housing and feeding, the author has assimilated the valuable experience gained by him at the Lucknow model farm, and the instructions given should prove of great benefit both to the professional who rears poultry for the market and the amateur who keeps fowls for domestic consumption. Many country medicines have been mentioned in the chapter on treatment of diseases, and some of them are no doubt both economical and beneficial. [S. M. J.]

* * *

The Cotton-growing Countries : Production and Trade.—Compiled by MR. JOHN HUBBOCK, Agent Technique of the Statistical Bureau of the International Institute of Agriculture, Rome, 1922. (John Heywood, Ltd., 121, Deansgate, Manchester ; 20-22, St. Bride Street, London, E. C. 4.) Price, 5s.

THIS monograph is an inventory of the world's cotton crops made up from various earlier publications on the subject and brought up to date from the results of a questionnaire sent to the governments of the known cotton-growing countries in 1921. The ground covered is wider than in any previous publication, though cropping details in many localities are somewhat scanty.

It is a decided step forward towards the attainment of a complete statistical picture of the world's cotton crops. The opportunity to tap the widest possible sources of information, such as is provided to the compiler in the International Institute of Agriculture, has been well used and the conciseness and methodical arrangement of material makes this small volume an invaluable means of reference for all those interested in cotton production.

A special feature is the large measure of success that has accompanied the effort to give, in analysis, as great detail of acreage under cotton, total yield and yield per acre, for the world at large, as has already been done for the American, Egyptian and Indian crops in particular. Differentiation between the production of

long and short staple cotton in the various countries is also emphasized.

Whilst this is probably the most comprehensive survey of its kind, it shows quite frankly the gaps that must be filled before the measure of the world's ability to increase its production of cotton can be remotely measured. The volume is important in indicating the vast extent of the unknown as well as the known factors. With China's cotton crop figures too uncertain to be included, the possibilities of Central Africa, N. and S. of the Equator, and of the depths of Brazil are only hinted at.

Tables on pages 132-142 give interesting figures of cotton exports from 93 countries and imports into 84 countries. The last five pages give cotton prices from 1912-1921 of Middling American in New Orleans, f. g. f. Sakel in Alexandria and G. O., M. and M. F. in Liverpool. [*The British Cotton Industry Research Association*, Vol. III, No. 4.]

NEW BOOKS
ON AGRICULTURE AND ALLIED SUBJECTS

1. Manual of Entomology with special reference to Economic Entomology, by H. Maxwell Lefroy, M.A. Pp. xvi+542. (London : Edward Arnold & Co.) Price, 35s.
2. The Irrigation of Sugarcane in Hawaii, by W. P. Alexander. Pp. v+109. (Honolulu and Hawaii : Hawaiian Sugar Planters' Association, 1923.)
3. Elementary Agriculture, by Henry J. Waters. Pp. ix+349 +6 plates. (Boston and London : Guin & Co.) Price, 5s. net.
4. Scientific Feeding of the Domestic Animals (authorized translation from the third German edition of Paul Fischer), by Martin Klimmer. Pp. 252. (London : Baillière, Tindall & Cox.) Price, 18s. net.
5. Insect Life, by C. A. Ealand. Pp. 352. (London : A. and C. Black, Ltd.) Price, 10s. net.
6. Practical Plant Ecology, by A. G. Tansley. Pp. 228. (London : G. Allen and Urwin.) Price, 7s. 6d.

THE following publications have been issued by the Imperial Department of Agriculture in India since our last issue :—

Memoir.

1. Studies in Inheritance in Cotton, I. History of a cross between *G. herbaceum* and *G. neglectum*, by G. L. Kottur, M.Ag. (Botanical Series, Vol. XII, No. 3.) Price, R. 1-4 or 1s. 9d.

Indigo Publication.

2. Indigo Experiments, 1922. (1) The effect on produce when vat liquor is allowed to stand in the beating vat and beating is delayed ; (2) the effect of neutralizing the liquor with caustic soda before beating, by J. H. Walton, M.A., M.Sc. (Indigo Publication No. 12.) Price, As. 4.

**LIST OF AGRICULTURAL PUBLICATIONS
IN INDIA FROM THE 1ST FEBRUARY
TO THE 31ST JULY, 1923**

No.	Title	Author	Where published
GENERAL AGRICULTURE			
1	<i>The Agricultural Journal of India</i> , Vol. XVIII, Parts II, III and IV. Price, R. 1-8 or 2s. per part; annual subscription, Rs. 6 or 9s. 6d.	Edited by the Agricultural Adviser to the Government of India.	Messrs. Thacker, Spink & Co., Calcutta.
2	Annual Report of the Board of Scientific Advice for India for 1921-22. Price, R. 1.	Issued by the Board of Scientific Advice for India.	Government Printing, India, Calcutta.
3	Summary of Tables showing the total area, area cultivated and uncultivated, area under irrigation and area under different crops in British India in the Agricultural Year 1921-22. Price, As. 4.	Issued by the Commercial Intelligence Department, India.	Ditto
4	Agricultural Statistics of Bengal for 1921-22. Price, R. 1-12.	Government of Bengal, Agriculture and Industries Department.	Bengal Government Press, Calcutta.
5	Cultivation of Jute for seed ..	R. S. Finlow, B.Sc., F.I.C., Offg. Director of Agriculture, Bengal.	Ditto
6	<i>Bengal Agricultural Journal</i> . (Quarterly.) (In English and Bengali.) Annual subscription, R. 1-4; single copy, As. 5.	Issued by the Department of Agriculture, Bengal.	Sreenath Press, Dacca.
7	Season and Crop Report of Bihar and Orissa for 1922-23. Price, R. 1.	Issued by the Department of Agriculture, Bihar and Orissa.	Government Printing, Bihar and Orissa, Patna.
8	Report on the Working and Administration of the United Provinces Government Gardens for the year 1921-22.	Issued by the Department of Agriculture, United Provinces.	Government Press, United Provinces, Allahabad.
9	Report on the Operations of the Department of Agriculture, Punjab, for the year ending the 30th June, 1922. Part I. Price, R. 1.	Issued by the Department of Agriculture, Punjab.	Government Printing, Punjab, Lahore.
10	Pamphlet on Orange Culture in the Punjab. Price, As. 5.	Ditto	Ditto

LIST OF AGRICULTURAL PUBLICATIONS—*contd.*

No.	Title	Author	Where published
<i>General Agriculture—contd.</i>			
11	Report on the third regular Wages Survey of the Punjab taken in December, 1922. Price, R. 1-2.	Issued by the Department of Agriculture, Punjab.	Government Printing, Punjab, Lahore.
12	Water Hyacinth (<i>Eichornia crassipes</i>). Punjab Department of Agriculture Leaflet No. 12. (Revised.)	Ditto	Ditto
13	Tractors and Tractor Implements. Punjab Department of Agriculture Leaflet No. 21 of 1923.	H. R. Stewart, Professor of Agriculture, and D. P. Johnston, Deputy Director of Agriculture, Lyallpur.	Ditto
14	Report on the complaints of the abnormal state of the Cotton crop in 1921. Price, Rs. 4-10.	D. Milne, B.Sc., Economic Botanist, Punjab.	Ditto
15	Graphs of Humidities and Temperature connected with the Report on the complaints of the abnormal state of the Cotton crop in 1921.	Ditto	Ditto
16	Report on the Cotton Survey of the Ludhiana District in 1920. Price, Rs. 14.	L. Jai Chand Luthra, M.Sc., Off. Economic Botanist, Punjab.	Ditto
17	Report on the Cotton Survey of the Shahpur District in 1916. Price, Rs. 25.	D. Milne, B.Sc., Economic Botanist, Punjab.	Ditto
18	Annual Report of the Department of Agriculture, Bombay Presidency, for the year 1921-22. Price, R. 1-5.	Issued by the Department of Agriculture, Bombay.	Government Central Press, Bombay.
19	A Note on Well-boring. Bombay Department of Agriculture Bulletin No. 111 of 1923. Price, As. 8.	W. M. Schutte, Agricultural Engineer to the Government of Bombay.	Ditto
20	Report on the Operations of the Department of Agriculture, Madras Presidency, for the year 1922-23.	Issued by the Department of Agriculture, Madras.	Government Press, Madras.
21	Annual Reports of Agricultural Stations in the Madras Presidency for 1922-23. (For official use only.)	Ditto	Ditto
22	Villagers' Calendar for 1923-24.	Ditto	Ditto
23	Year Book for 1922. Price, As. 10.	Ditto	Ditto

LIST OF AGRICULTURAL PUBLICATIONS—*contd.*

No.	Title	Author	Where published
<i>General Agriculture—contd.</i>			
24	A Popular Account of the work of the Madras Agricultural Department.	Issued by the Department of Agriculture, Madras.	Government Press, Madras.
25	The relations existing between the Research Institute, the Agricultural Stations and the Ryots. Madras Department of Agriculture Leaflet No. 21.	Ditto	Ditto
26	Bone Crushing Mill. Madras Department of Agriculture Leaflet No. 22.	Ditto	Ditto
27	The Agricultural College. Madras Department of Agriculture Leaflet No. 23.	Ditto	Ditto
28	A Scheme for the distribution of breeding bulls. (In vernaculars only.) Madras Department of Agriculture Leaflet No. 24.	Ditto	Ditto
29	The Sindewahi Furnace for Jaggery Manufacture. Madras Department of Agriculture Leaflet No. 25.	Ditto	Ditto
30	A Note on the Demonstration of Agricultural Improvements carried in V Circle (Tanjore and Trichinopoly) during the first crop season in 1922-23. Madras Department of Agriculture Leaflet No. 27.	Ditto	Ditto
31	Note on the Agricultural Middle School at Anakapalle. (In Telugu only.) Madras Department of Agriculture Leaflet No. 28.	Ditto	Ditto
32	Note on the improved methods of paddy and sugarcane cultivation. (In Telugu only.) Madras Department of Agriculture Leaflet No. 29.	Ditto	Ditto

LIST OF AGRICULTURAL PUBLICATIONS

675

LIST OF AGRICULTURAL PUBLICATIONS—contd.

No.	Title	Author	Where published
<i>General Agriculture—contd.</i>			
33	How to can fruits and vegetables at home. (In English and Bengali.) Assam Department of Agriculture Leaflet No. 1 of 1923.	Issued by the Department of Agriculture, Assam.	Assam Secretariat Printing Office, Shillong.
34	Report on the Operations of the Department of Agriculture, Burma, for the year ended the 30th June, 1922. Price, R. 1.	Issued by the Department of Agriculture, Burma.	Government Printing, Burma, Rangoon.
35	Agricultural Calendar for 1923-24. (In Burmese.)	Ditto	Ditto
36	Report of the Agricultural Chemist, Burma, for the year ended the 30th June, 1922. Price, As 4.	Ditto	Ditto
37	Report of the Economic Botanist, Burma, for the year ended the 30th June, 1922. Price, As. 4.	Ditto	Ditto
38	Report of the Assistant Director of Agriculture (Entomology), Burma, for the year ended the 30th June, 1922. Price, As. 4.	Ditto	Ditto
39	Report of the Agricultural Engineer, Burma, for the year ended the 30th June, 1922. Price, As. 8.	Ditto	Ditto
40	Report on Sericultural Work for the year ended the 30th June, 1922. Price, As. 4.	Ditto	Ditto
41	Report on the Pump Irrigation at Chaungu (Sagaing), 1921-22. Price, As. 4.	Ditto	Ditto
42	Report on the Mandalay Agricultural Station for the year ended the 30th June, 1922. Price, As. 4.	Ditto	Ditto
43	Report on the Allannmyo Agricultural Station for the year ended the 30th June, 1922. Price, As. 4.	Ditto	Ditto
44	Report on the Hopin Agricultural Station for the year ended the 30th June, 1922. Price, As. 4.	Ditto	Ditto

LIST OF AGRICULTURAL PUBLICATIONS—*contd.*

No.	Title	Author	Where published
<i>General Agriculture—contd.</i>			
45	Report on the Padu Agricultural Station for the year ended the 30th June, 1922. Price, As. 4.	Issued by the Department of Agriculture, Burma.	Government Printing, Burma, Rangoon.
46	Report on the Yawngwe Agricultural Station for the year ended the 30th June, 1922. Price, As. 4.	Ditto	Ditto
47	Report on the Tatkon Agricultural Station for the year ended the 30th June, 1922. Price, As. 4.	Ditto	Ditto
48	Report on the Hmawbi Agricultural Station for the year ended the 30th June, 1922. Price, As. 4.	Ditto	Ditto
49	Report on the Mahlaing Cotton Experimental Station for the year ended the 30th June, 1922. Price, As. 4.	Ditto	Ditto
50	Report of the Agricultural Stations at Tarnab and Haripur in the North-West Frontier Province for the two years ending the 30th June, 1922.	Issued by the Department of Agriculture, North-West Frontier Province.	Government Press, Peshawar.
51	Report on the Operations of the Department of Agriculture and Fisheries, Travancore, for the year 1921-22.	Issued by the Department of Agriculture and Fisheries, Travancore.	Government Press, Trivandrum.
52	Annual Report of the Agricultural Department, Gwalior Government, for 1921-22.	Issued by the Department of Agriculture, Gwalior.	Alijah Darbar Press, Lashkar.
53	Annual Report of the Agricultural Department, Mysore, for the year 1921-22.	Issued by the Department of Agriculture, Mysore.	Government Press, Bangalore.
54	Report on the administration of the village Panchayats and Department of Agriculture in the Cochin State for the year 1921-22.	Issued by the Department of Agriculture, Cochin.	Government Press, Ernaculam.
55	<i>The Journal of the Madras Agricultural Students' Union.</i> (Monthly.) Annual subscription, Rs. 2.	Madras Agricultural Students' Union.	Literary Sun Press, Coimbatore.
56	<i>Quarterly Journal of the Indian Tea Association.</i> Price, As. 6 per copy.	Scientific Department of the Indian Tea Association, Calcutta.	Catholic Orphan Press, Calcutta.

LIST OF AGRICULTURAL PUBLICATIONS—*contd.*

No.	Title	Author	Where published
<i>General Agriculture—conold.</i>			
57	<i>Poona Agricultural College Magazine.</i> (Quarterly.) Annual subscription, Rs. 2.	College Magazine Committee, Poona.	Arya Bhusan Press, Poona.
58	<i>Journal of the Mysore Agricultural and Experimental Union.</i> (Quarterly.) Annual subscription, Rs. 3.	Mysore Agricultural Experimental Union.	Bangalore Press, Bangalore.
59	<i>Indian Scientific Agriculturist.</i> Annual subscription, Rs. 4.	Alliance Advertising Association, Ltd., Calcutta.	Messrs. Bera & Co., Printers, Calcutta.
60	<i>The Planters' Chronicle.</i> (Weekly.) Price, As. 8 per copy.	United Planters' Association of South India, Coimbatore.	E. P. Works, Coimbatore.

AGRICULTURAL CHEMISTRY

61	Chemical Studies on Safflower Seed and its Germination. Memoirs of the Department of Agriculture in India, Chemical Series, Vol. VI, No. 7. Price, As. 10 or 1s.	V. A. Tamhane, m.sc., m.ag., Soil Physicist to Government, Bombay.	Messrs. Thacker, Spink & Co., Calcutta.
62	Note on the Permanent Manurial Plots, Coimbatore. Memoirs of the Department of Agriculture in India, Chemical Series, Vol. VI, No. 8. Price, R. 1-4 or 1s. 9d.	Ronald V. Norris, d.sc., Government Agricultural Chemist, Coimbatore.	Ditto
63	A Note on Hydrocyanic Acid in the Burma Bean (<i>Phaseolus lunatus</i> sp). Memoirs of the Department of Agriculture in India, Chemical Series, Vol. VII, No. 1. Price, As. 12 or 1s.	F. J. Warth, b.sc., m.sc., Physiological Chemist, Pusa.	Ditto
64	Studies of an Acid Soil in Assam, II. Memoirs of the Department of Agriculture in India, Chemical Series, Vol. VII, No. 2. Price, As. 12 or 1s.	A. A. Meggitt, b.sc., f.c.s., Agricultural Chemist, Assam.	Ditto

MYCOLOGY

65	<i>Helminthosporium</i> spp. on Cereals and Sugarcane in India, Part I. (Diseases of <i>Zea Mays</i> and <i>Sorghum vulgare</i> caused by species of <i>Helminthosporium</i> .) Memoirs of the Department of Agriculture in India, Botanical Series, Vol. XI, No. 10. Price, R. 1 or 1s. 4d.	M. Mitra, m.sc., First Assistant to the Imperial Mycologist.	Messrs. Thacker, Spink & Co., Calcutt.
----	--	--	--

LIST OF AGRICULTURAL PUBLICATIONS—*contd.*

No.	Title	Author	Where published
<i>Mycology—concltd.</i>			
66	I. History of the Operations against Bud Rot of Palms in South India. II. Inoculation Experiments with <i>Phytophthora palmivora</i> Butl. on <i>Borassus javellifer</i> Linn. and <i>Cocos nucifera</i> Linn. Memoirs of the Department of Agriculture in India, Botanical Series, Vol. XII, No. 2. Price, R. 1-4 or 2s.	W. McRae, M.A., B.Sc., Acting Imperial Mycologist.	Messrs. Thacker, Spink & Co., Calcutta.
67	Red rot disease (Saru or Soka) in thick sugarcane. Punjab Department of Agriculture Leaflet No. 18. (Revised, 1923.)	D. Milne, B.Sc., Economic Botanist, Punjab.	Government Printing, Punjab, Lahore.
68	Treatment of Smut by Copper Sulphate. Madras Department of Agriculture Leaflet No. 26. (In Telugu.)	Issued by the Depart- ment of Agriculture, Madras.	Government Press, Madras.

AGRICULTURAL BACTERIOLOGY

69	Some Observations on Barren Soils of Lower Bari Doab Colony in the Punjab. Punjab Agricultural Research Institute Bulletin No. 145. Price, As. 3.	S. M. Nasir, Bacteriological Assistant to the Agricultural Chemist, Punjab.	Government Printing, India, Calcutta.
----	---	---	--

ENTOMOLOGY

70	<i>Platyedra gossypiella</i> , Saund., The Pink Boll-worm, in South India, 1920-21. Memoirs of the Department of Agriculture in India, Entomological Series, Vol. VII, No. 10. Price, As. 12 or 1s.	E. Ballard, B.A., F.E.S., Government Ento- mologist, Madras.	Messrs. Thacker, Spink & Co., Calcutta.
71	Studies in Indian Dermaptera. Memoirs of the Department of Agriculture in India, Entomological Series, Vol. VII, No. 11. Price, R. 1-4 or 1s. 9d.	Morgan Hebard.	Ditto
72	Further Notes on <i>Pempheres affinis</i> , Fst. (The Cotton Stem Weevil). Memoirs of the Department of Agriculture in India, Entomological Series, Vol. VII, No. 12. Price, R. 1 or 1s. 4d.	E. Ballard, B.A., F.E.S., Government Ento- mologist, Madras.	Ditto

LIST OF AGRICULTURAL PUBLICATIONS—concl'd.

No.	Title	Author	Where published
<i>Entomology—concl'd.</i>			
73	An Account of Experiments on the Control of <i>Siga</i> (<i>Schænobius</i>) <i>incertellus</i> in the Godavari Delta. Memoirs of the Department of Agriculture in India, Entomological Series, Vol. VII, No. 13. Price, As. 14 or 1s. 4d.	E. Ballard, B.A., F.E.S., Government Entomologist, Madras.	Messrs. Thacker, Spink & Co., Calcutta.
74	No. 1— <i>Hydrophilidæ</i> of India (Col.). A List of the Species in the Collection of the Agricultural Research Institute, Pusa (Bihar). No. 2—An Annotated List of Ichneumonidæ in the Pusa Collection. No. 3—A Second Note on Odonata in the Pusa Collection. Memoirs of the Department of Agriculture in India, Entomological Series, Vol. VIII, Nos. 1, 2 and 3. Price, R. 1 or 1s. 6d.	A. d'Orchymont. G. R. Dutt, B.A., Personal Assistant to the Imperial Entomologist. Major F. C. Fraser, I.M.S.	Ditto
75	Notes on Indian Muscida:— 1. <i>Calliphorinæ Testaceæ</i> . 2. <i>Rhininiæ</i> . Memoirs of the Department of Agriculture in India, Entomological Series, Vol. VIII, No. 4. Price, As. 12 or 1s.	Ronald Senior-White, F.E.S., Malariologist, The Kepitigalla Rubber Estates, Ltd., Ceylon.	Ditto
76	The Cultivation of Lac in the Plains of India (<i>Tachardia lacca</i> , Kerr). Pusa Agricultural Research Institute Bulletin No. 142. Price, R. 1-8.	Rai Bahadur C. S. Misra, B.A., First Assistant to the Imperial Entomologist.	Government Printing, India, Calcutta.
77	Ber (<i>Zizyphus jujuba</i>) Fruit and its Fly Pest. Pusa Agricultural Research Institute Bulletin No. 143. Price, As. 6.	J. L. Khare, F.E.S., Lecturer in Entomology, Agricultural College, Nagpur.	Ditto
78	Catalogue of Indian Insects. Part 2—Culicidæ. Price, R. 1-10.	Ronald Senior-White, F.E.S., Malariologist, The Kepitigalla Rubber Estates, Ltd., Ceylon.	Ditto
79	Catalogue of Indian Insects. Part 3—Bombyliidæ. Price, As. 8.	Ditto	Ditto
80	List of Important Insects injurious to cultivated crops in South India. Madras Department of Agriculture Bulletin No. 86.	I. V. Ramakrishna Ayyar, Assistant Entomologist, Madras.	Government Press, Madras.

LIST OF AGRICULTURAL PUBLICATIONS—*concl.*

No.	Title	Author	Where published
VETERINARY			
81	Observations on the Morphology and Life-Cycle of <i>Filaria recondita</i> Grassi. Pusa Agricultural Research Institute Bulletin No. 144. Price, As. 6.	M. Anant Narayan Rao, Acting Assistant Professor, Madras Veterinary College.	Government Printing, India, Calcutta.
82	Annual Report of the Bengal Veterinary College for 1922-23.	Issued by the Civil Veterinary Department, Bengal.	Bengal Government Press, Calcutta.
83	Annual Report of the Civil Veterinary Department, United Provinces, for the year ending the 31st March, 1922. Price, R. 1-2.	Issued by the Civil Veterinary Department, United Provinces.	Government Press, United Provinces, Allahabad.
84	Annual Report of the Camel Specialist, Punjab, for 1922-23. Price, As. 4.	Issued by the Department of Agriculture, Punjab.	Government Printing, Punjab, Lahore.
85	Surra Transmission Experiments with <i>Tabanus allimediis</i> and Ticks. Punjab Veterinary Bulletin No. 12 of 1923.	Ditto	Ditto

	PAGE
ANIMAL HUSBANDRY	330, 399, 604
ANSTEAD, R. D. How to make manuring profitable in India ..	534
ANTHRAX	386
APICULTURE. Mesquite as aid to—	147
AYYAR, T. V. RAMAKRISHNA. Some insect pests of fruit trees in South India	50
B	
BACTERIAL INFECTION OF COTTON BOLLS. E. Ballard and D. Norris ..	40
BALLARD, E., AND NORRIS, D. Bacterial infection of cotton bolls ..	40
BANANAS. Insect pests of—	54
BARKAT ALI, AND WILSDON, B. H. Nitrogen fixation in arid climates ..	158
<i>Batocera rubus</i>	52
BEE-EATER, COMMON INDIAN	1
BEE KEEPING. Mesquite as aid to—	147
BEETLE, RHINOCEROS	183, 423
BENGAL JUNGLE-BABBLER	99
„ TREE-PIE	563
„ WATER HYACINTH COMMITTEE. Report of—	424
BIRDS. Some common Indian—. T. Bainbrigge Fletcher and C. M. Inglis	1, 99, 199, 323, 451, 563
BIRDS OF INDIA. Common—. Douglas Dewar. (Review) ..	448
BOARD OF AGRICULTURE IN INDIA	646
BOLL WEEVIL. Control of cotton—in U. S.	403
BOLLWORM, PINK. Control of—in Brazil	429
BONEMEAL. How to make manuring with—profitable	534
BONEMEAL AS MANURE FOR PADDY	104
BOOKS. New—on agriculture and allied subjects 96, 196, 309, 449, 562, 671	
BREEDING. Cattle—in India	330, 399, 560, 604
„ Poultry—in India	510, 512, 547, 668
BROWN, W. ROBERTSON. Mesquite	596
„ „ „ New spring-tooth harrow	647
BUD-ROT OF PALMYRA PALMS. Operations against—on the East Coast. W. McRae	487
BULLOCKS. Nitrogen metabolism stall for—	267
BULLS, SAHIWAL. Sale of—at Ferozepore	420
BURT, B. C. Determination of true staple length of Indian cottons ..	287
„ „ Technological research on raw materials and its relation to plant breeding	374

	PAGE
BURT, B. C. Testing cotton fibres for strength	81
BUTTER MAKING. Principles and practice of— G. L. McKay and C. Larsen. (Review)	307
C	
CACTUS. Cultivation of—as fodder	417
CATTLE. Contagious diseases of—in India	386
,, Digestion of paddy straw by Indian—	456
,, Milk yield of British—	84
,, ,, ,, Indian—	334
CATTLE BREEDING. W. Smith	604
,, FODDER. Cactus as—	417
,, ,, Mesquite as—	144, 596
,, PROBLEM IN INDIA	330, 399, 560, 604
,, ,, OF THE UNITED PROVINCES. H. M. Leake	330
CATTLE, SAHIWAL DAIRY. Sale of—at Ferozepore	420
<i>Chaetodacus</i> spp.	52
CHEEMA, G. S., AND GANDHI, S. R. Influence of notching on yield of fig trees	501
<i>Chomelia asiatica</i> AS GREEN MANURE	132
CITRUS. Insect pests of—	53
CLIMATE. Effect of—on nitrogen fixation	158
,, ,, ,, ripening of sugarcane	410
COCCIDÆ OF CEYLON. E. Ernest Green. (Review)	93
COCONUT. Control of Rhinoceros beetle on—	183, 423
COCONUT CULTIVATION. Science and practice of— H. C. Sampson. (Review)	665
,, FLOWERS. Ripening of—	561
COIMBATORE CANE SEEDLINGS. Mill trials with—	249
CO-OPERATIVE COMMISSION SALE SHOP, LYALLPUR	115
,, MARKETING OF COTTON	73, 129, 180, 639
,, MOVEMENT IN INDIA. Panchanandas Mukherji. (Review)	445
<i>Corvus coronoides levaillanti</i>	451
,, <i>splendens</i>	323
COTTON. Co-operative marketing of—	73, 129, 180, 639
,, Effect of dilute acids on growth of—	153
,, Historical account of—	660
,, Inbreeding in—	465
,, Linkage of seed fuzziness and lint in—	572

	PAGE
COTTON. Need for fresh—fields	653
„ Testing spinning value of—	290
COTTON, AMERICAN. Spinning test of—	658
COTTON BOLL DISEASES	45
„ „ WEEVIL	403
„ „ WORM	429
„ BOLLS. Bacterial infection of—	40
„ „ Shedding of—	41, 188
„ BULLETIN, INTERNATIONAL	94
„ CEARA	657
„ CHINESE	550
„ CONFERENCE, INTERNATIONAL. Resolutions of—held at Rio De Janeiro, 1922	426
„ CULTIVATION IN BRAZIL	426
„ „ „ CHINA	188, 295, 550
„ „ „ NATAL	189
„ „ „ SOUTH CAROLINA	553
„ „ „ WEST AFRICA	189
„ EGYPTIAN. Decline in average yield of—	525
„ FIBRES. Physical measurements on—and their graphical representation	293
„ „ Testing—for strength	81
„ FROM THE GEZIRA. James Currie	281
„ FUNGUS. Description of a new—	295
„ GROWING COUNTRIES: PRODUCTION AND TRADE. (Review)	669
„ HAIR. Clinging power of—	554
„ „ Decay of—	294
„ „ Testing of—	88
„ HARVESTER. Bennett—	553
„ INSECTS. Control of—	403, 429
„ PLANT. Linkage relations in—	572
„ PRODUCTION AND CONSUMPTION. World's—from 1908-09 to 1922-23	439
„ „ „ CO-OPERATIVES. A. H. Stone	639
„ RESEARCH	88, 188, 294, 552, 658
„ „ STUDENTSHIPS	532
„ SEA ISLAND. Shedding of flower-buds and bolls of—	188
„ SEED. Germination of—	554
„ SPINNING IN CHINA	187

	PAGE
COTTON STAPLE TEST	659
" WAX. Composition of—	552
" WILT. Control of—	188
" YARN. Testing of—	89
COTTONS, INDIAN. Blending of American and— ..	548
" " Determination of true staple length of— ..	287
" " Scope for technological research with— ..	376
COW, FIRST 3,000-GALLON	84
CROP PRODUCTION AND WATER SUPPLY	10
CROPPING. Loss of nitrogen by—	159
CROSS-BREEDING OF CATTLE	560
<i>Crotalaria juncea</i> AS GREEN MANURE	219
CROW, HOUSE	323
" JUNGLE	451
CULTIVATION OF POTATO IN ITALY. G. S. Kulkarni ..	599
" " SPINELESS <i>Opuntia</i> IN WESTERN INDIA ..	417
CULTIVATOR. Nobelius spring-tooth—	647
CURRIE, JAMES. Cotton from the Gezira	281
DAIRY CATTLE. Breeding of—in India	330, 399, 560, 604
" " Feeding of—	94
" CONGRESS. World's—	546
" COWS. Identification of—by noseprint	185
" INDUSTRY OF DENMARK	634
DANISH AGRICULTURE AND THE HYGIENE OF THE NATION ..	634
DASTUR, J. F. Mosaic disease of sugarcane in India ..	505
<i>Dendrocitta rufa vagabunda</i>	563
<i>Dhaincha</i> AS GREEN MANURE FOR PADDY	104
DIGESTION EXPERIMENTS WITH PADDY STRAW. F. J. Warth ..	456
DISEASE. Bud-rot—of palmyra palms	487
" Cotton boll—	45
" Fiji—of sugarcane	651
" <i>Fusarium</i> —of gram	608
" " " potato	515
" Mosaic—of sugarcane	505
" New fungus—of cotton	295
" Root—of sugarcane in Java	536
" Wilt—of cotton	188

	PAGE
DOBBS, A. C. Wealth and welfare of Punjab. H. C. Calvert. (Review)	272
DYE PLANTS OF NAGA HILLS	570
ECONOMIC HOLDING FOR A TRACTOR	31
ECONOMIC PLANTS OF NAGA HILLS. J. H. Hutton ..	567
EDUCATION. Higher agricultural—in India	528
„ Veterinary—in India	380
EGG-LAYING COMPETITION. Report on third—. A. K. Fawkes	539
<i>Eichornia crassipes</i> IN BENGAL	424
ELECTRO-CULTURE	167
EMPIRE COTTON GROWING CORPORATION. Journal of the—	299
ENTOMOLOGICAL MEETING, FIFTH	257
FAMINE FODDERS	144, 417, 596
FARM BUILDINGS. W. A. Foster and D. G. Carter. (Review)	308
„ PRODUCE. Marketing of—	115
FARMYARD MANURE. Superiority of—over artificials ..	629
FAULKNER, O. T. Unavoidable error of field experiments	238
FAWKES, A. K. Poultry breeding in the United Provinces	510
„ „ „ Report on the third all-India egg-laying competition	539
FEEDING OF DAIRY CATTLE. Andrew C. McCandlish. (Review)	94
FERMENTED GREEN MANURES. Value of—	219
FERNS OF BOMBAY. E. Blatter and J. F. d'Almeida. (Review)	194
FERTILIZERS, INDIGENOUS. Need to reduce price of— ..	534
FIBRE. New—substitute for jute	547
FIBRE PLANTS OF NAGA HILLS	567
FIBRES. Study of flax and kindred—	296
FIELD EXPERIMENTS. Probable error in—	238, 475, 659
FIG TREES. Influence of notching on yield of—. G. S. Cheema and S. R. Gandhi	501
FIJI DISEASE OF SUGARCANE. Cause and control of— ..	651
FLAX. Study of—and kindred fibres	296
FLETCHER, T. BAINBRIGGE, AND INGLIS, C. M. Some common Indian birds 1, 99, 199, 323, 451, 563	
FLOWERING IN SUGARCANE	538
FODDER. Cactus as—	417
„ Mesquite pods as—	144, 596

	PAGE
FODDER SUPPLY IN U. P.	335
FRUIT TREES. Some insect pests of—in South India	50
FURNACES FOR THE MANUFACTURE OF <i>gur</i> . H. R. Stewart and Kharak Singh	584
FURTADO C. X. Ripening of coconut flowers. (Correspondence)	561
<i>Fusarium</i> CAUSING WILT AND DRY ROT OF POTATOES. Relationship of species of—in Western India. S. L. Ajrekar and M. N. Kamat	515
„ WILT OF GRAM. Note on—in Burma. A. McKerral	608

G

GANDHI, S. R., AND CHEEMA, G. S. Influence of notching on yield of fig trees	501
GHOSH, MANMATHANATH, AND TAYLOR, C. SOMERS. Experiments on green-manuring of rice	104
GOKHALE, V. G. Rhinoceros beetle	183
GRAM. <i>Fusarium</i> wilt-resistant variety of—	608
GRAPE. Insect pests of—	55
GREEN MANURE. <i>Chomelia asiatica</i> and <i>Pavetta indica</i> as—	132
„ „ <i>Dhaincha (Sesbania aculeata)</i> as—	104
„ „ Sann-hemp as—	219
„ MANURES. Value of fermented—	219
„ MANURING OF RICE. Experiments on—	104
„ „ WITH SUPERPHOSPHATE	104, 230
GUAVA. Insect pests of—	55
<i>Gur</i> . Furnaces for manufacture of—	584

H

HAPPY INDIA, AS IT MIGHT BE IF GUIDED BY MODERN SCIENCE. Arnold Lupton. (Review)	447
HARLAND, S. C. Inbreeding in cotton and its importance to the plant breeder	465
HARROW. A new spring-tooth—	647
HEIFER, FIRST 2,000-GALLON	84
HOUSE CROW	323
HOWARD, ALBERT, AND HOWARD, G. L. C. Note on theory of phos- phatic depletion in soils of Bihar	148
HOWARD, GABRIELLE L. C. Rôle of plant physiology in agriculture	204

	PAGE
HUTCHINSON, C. M. Improved form of Kjeldahl apparatus ..	415
" " " Value of fermented green manures as tested at Pusa by prevalued plot method ..	219
HUTTON, J. H. Economic plants of Naga Hills ..	567
HYACINTH. Water—in Bengal	424

I

<i>Idioceris</i> spp.	51
IMPLEMENT. New tillage—for India	647
IMPLEMENTS FOR TRACTORS	35
IN-BREEDING IN COTTON AND ITS IMPORTANCE TO THE PLANT BREEDER.	
S. C. Harland	465
INDIAN BIRDS. Some common--	1, 99, 199, 323, 451, 563
INDIAN CATTLE PROBLEM	330, 399, 560, 604
INDIGO CROP IN BIHAR	151, 211
INGLIS, C. M., AND FLETCHER, T. BAINBRIGGE. Some common Indian birds	1, 99, 199, 323, 451, 563
INSECT PARASITES OF ANIMALS	395
INSECT PESTS. Control measures against—	56, 403, 429
INSECT PESTS OF COTTON BOLLS	43, 403, 429
" " " FRUIT TREES IN SOUTH INDIA. T. V. Ramakrishna Ayyar	50
INSECTICIDAL METHODS OF PEST CONTROL	57
INSECTS USED AS FOOD	259
IRRIGATION. Extension of—in the United Provinces	10
" Wheat yield with varying quantities of—	206

J

JAK. Insect pests of—	54
JOHNSTON, D. P., AND STEWART, H. R. Experiments on wheat threshing at Lyallpur	614
" " " " " " " Tractor cultivation at Lyallpur, Punjab	23
JOWAR. Use of—in malting operations	362
JOSHI, P. G. Distribution of living plants by post	178
JUNGLE-BABBLER, BENGAL	99
JUNGLE CROW	451
JUTE. Malvavisco as substitute for—	547

K

KAMAT, M. N., AND AJREKAR, S. I. Relationship of species of <i>Fusarium</i> causing wilt and dry rot of potatoes	515
KHARAK SINGH AND STEWART, H. R. Furnaces for manufacture of <i>gur</i>	584
KJELDAHL APPARATUS. An improved form of—	415
KOTHAWALA, Z. R. Milk supply of Bombay city	80
KULKARNI, G. S. Cultivation of potato in Italy	599
KUNHIKANNAN, K. A useful plant for India	144
LEAKE, H. M. Cattle problem of the United Provinces	330
,, ,, ,, Trend of agricultural development in United Provinces	10
LEGUMINOUS CROPS. Effect of adding nitrogen on yield of—	207
,, GREEN MANURES	104, 219
,, PLANTS. Nitrogen fixation by non—	132
LINKAGE RELATIONS IN COTTON PLANT. K. I. Thadani	572
LIPMAN, C. B., AND TAYLOR, J. K. Power of wheat plant to fix atmospheric nitrogen	155
LYMPHANGITIS. Infectious—and contagious nasal granuloma of cattle ..	397

M

MAIZE. In-breeding in—	465
MALTING. <i>Sorghum</i> as a substitute for barley in—	362
,, Technique of—	366
MANGO. Insect pests of—	51
,, Root pruning of—	648
MANGOLD. Trials with—at Pusa	422
MANURE. <i>Chomelia asiatica</i> and <i>Pavetta indica</i> as green—	132
,, <i>Dhaincha</i> as green—	104
,, Sann-hemp as green—	219
MANURING. Green—with superphosphate	104, 230
,, How to make—profitable in India	534
MARKETING. Co-operative—of cotton	73, 129, 180, 639
MARKETING OF AGRICULTURAL PRODUCE	115
MATSON, J. Cattle problem in India. (Correspondence)	560
MALVAVISCO AS SUBSTITUTE FOR JUTE	547
MCGLASHAN FURNACE	588

McKERRAL, A. Note on <i>Fusarium</i> wilt of gram in Burma and measures taken to combat it	608
McRAE, W. Operations against the bud-rot of palmyra palms on the East Coast	487
MELONS. Insect pests of—	55
<i>Merops orientalis orientalis</i>	1
MESQUITE	144, 596
MEXICAN MALVAVISCO PLANT AS SUBSTITUTE FOR JUTE	547
MICROMETRIC SLIDE RULE	658
MILK SUPPLY IN INDIAN CITIES	340
" " OF BOMBAY. Statistics of—	80
" YIELD OF INDIAN CATTLE	334
MILKING RECORDS, BRITISH	84
MILL TRIALS OF COIMBATORE SUGARCANE SEEDLINGS. Wynne Sayer	249
MILLETS. Pollination methods amongst lesser—	580
" Use of—in malting operations	362
MOSAIC DISEASE OF SUGARCANE IN INDIA. J. F. Dastur	505
MOTOR TRACTOR TRIALS AT LYALLPUR	23
MOUNT, HARRY A. Getting along with the boll weevil	403
MUTILATIONS. Effect of—on metabolism of plant	214
MYNAH, COMMON	199

N

NITROGEN. Effect of adding—on yield of legumes	207
" Effect of withholding—on yield of tomatoes	208
" Loss of—by cropping	159
NITROGEN FIXATION. Symbiotic—in non-leguminous plants	132
" FIXATION BY WHEAT PLANT	155
" " IN ARID CLIMATES	158
" METABOLISM STALL FOR BULLOCKS. F. J. Warth	267
NORRIS, D., AND BALLARD, E. Bacterial infection of cotton bolls	40
" ROLAND V., AND VISWANATH, B. <i>Sorghum</i> as a substitute for barley in malting operations	362
NOTCHING. Influence of—on yield of fig trees	501

<i>Ophideres fullonica</i>	53
<i>Opuntia</i> . Spineless—in Western India	417
<i>Oryctes rhinoceros</i>	183, 423

	PAGE
P	
PADDY. Green-manuring of—	104
„ Probable error in variety trials with—	475
PADDY STRAW. Digestion experiments with	456
PALMS. Sugar production from tropical—	184
PALMS, PALMYRA. Bud-rot of—	487
<i>Panicum miliare</i> . Pollination in—	580
<i>Pavetta indica</i> AS GREEN MANURE	132
PERSONAL NOTES, APPOINTMENTS AND TRANSFERS, MEETINGS AND CONFERENCES, ETC.	90, 190, 303, 441, 555, 662
PEST. Water hyacinth—in Bengal	424
PESTS. Insect—of cotton	43, 403, 429
„ „ —of fruit trees	50
PHOSPHATE. Effect of—in Bihar soils	152
„ Green manuring with—	104, 230
PHOSPHATIC DEPLETION IN SOILS OF BIHAR. Note on theory of— Albert Howard and Gabrielle L. C. Howard	148
<i>Phytophthora palmivora</i>	487
PILLAI, N. KUNJAN. Soil researches and their application to practical agriculture	349
PLANT BREEDING. Importance of inbreeding in—	465
„ „ Technological research on raw materials and its relation to—	374
„ DISEASE. Relation between—and physiological state of host plant	215
„ DISTRIBUTION. Effect of soil acidity on—	545
„ PHYSIOLOGY. Rôle of—in agriculture. Gabrielle L. C. Howard	204
„ PRODUCE. Effect of environmental conditions on—	206
PLANTS. Distribution of living—by post	178
PLANTS (ECONOMIC) OF NAGA HILLS	567
PLOUGH. Spiral cutter—	297
POLLINATION METHODS AMONGST THE LESSER MILLETS. W. Youngman and S. C. Roy	580
POMEGRANATE. Insect pests of—	54
POST-GRADUATE TRAINING IN AGRICULTURE AT PUSA	528
POTATO. Cultivation of—in Italy	599
POTATOES. <i>Fusarium</i> diseases of—	515
„ Restrictions on import of—	182
POULTRY. United Provinces—Association	547

	PAGE
POULTRY BREEDING IN UNITED PROVINCES. A. K. Fawkes ..	510
„ COMPETITION. Third all-India—	539
„ FARM AT ETAH. A. E. Slater	512
„ KEEPING. Key to—. Tahir H. Qurashy. (Review) ..	668
PRICKLY PEAR. Cultivation of—as fodder	417
PROBABLE ERROR IN VARIETY TRIALS	238, 475, 659
<i>Prosopis juliflora</i>	144, 596
PUNJAB. Wealth and welfare of the—. H. Calvert. (Review) ..	272
PUNJAB SOILS. Nitrogen fixation in—	158

R

RABIES	396
RAJ KISHORE SINGH. Root pruning of mango plant ..	648
RAO, K. ADINARAYAN. Symbiotic nitrogen fixation in non-leguminous plants .. .	132
RAO, U. VITTAL. Rhinoceros beetle	423
RATIONS. Maintenance—for bullocks	456
RHINOCEROS BEETLE	183, 423
RICE. Experiments on the green-manuring of—. C. Somers Taylor and M. N. Ghosh	104
„ Probable error in variety trials with—	475
RICE STRAW. Digestion experiments with—	456
RINDERPEST	388
ROOT CROPS. Trials with—at Pusa	422
„ DISEASE OF SUGARCANE IN JAVA	536
„ PRUNING OF MANGO PLANT	648
„ SYSTEM. Effect of temperature on plant—	294
ROTHAMSTED AND AGRICULTURAL SCIENCE. John Russell ..	621
ROY, S. C., AND YOUNGMAN, W. Pollination methods amongst lesser millets	580
RUSSELL, JOHN. Rothamsted and agricultural science ..	621

S

SAMPSON, H. C. Appreciation of—	6
SANN-HEMP AS GREEN MANURE	219
SARKAR, B. N. On the probable error in variety trials with paddy ..	475
SAYER, WYNNE. Mill trials of Coimbatore sugarcane seedlings ..	249
SCIENCE AND CROP PRODUCTION	349, 621
SELF-FERTILIZATION IN COTTON	465

	PAGE
<i>Sesbania aculeata</i> AS GREEN MANURE	104
SEVEN SISTERS	99
SHEEP. Diseases of—	398
,, New—fodder for India	144, 596
SLATER, A. E. Etah mission poultry farm	512
SMITH, W. Cattle breeding	604
SOIL. Living organisms in—	631
,, Mechanical tillage of—for sugarcane	176
SOIL ACIDITY AND PLANT DISTRIBUTION	545
,, AERATION	151, 211
,, RESEARCHES AND THEIR APPLICATION TO PRACTICAL AGRICULTURE.	
N. Kunjan Pillai	349
,, AT ROTHAMSTED	621
,, SICKNESS. Protozoa theory of—	354
SOILS OF BIHAR. Phosphatic depletion in—	148
,, ,, PUNJAB. Nitrogen fixation in—	158
SORGHUM AS A SUBSTITUTE FOR BARLEY IN MALTING OPERATIONS.	
Roland V. Norris and B. Viswanath	362
STAPLE DIAGRAMS. Apparatus for—	86
STEWART, H. R., AND JOHNSTON, D. P. Experiments on wheat thresh-	
ing at Lyallpur	614
,, ,, ,, ,, ,, Tractor cultivation at Lyallpur,	
Punjab	23
,, ,, ,, KHARAK SINGH. Furnaces for manufacture of	
gur	584
STONE, A. H. Cotton production and co-operatives	639
STRAW, RICE. Digestion experiments with—	456
SUGAR. Hawaiian—factory results for 1922	521
SUGAR (CRUDE, UNREFINED). Furnaces for manufacture of—	584
,, PRODUCTION FROM TROPICAL PALMS	184
SUGARCANE. Cause and control of Fiji disease of—	651
,, Effect of climate on ripening of—	410
,, Flowering in—	538
,, Formation of sugar and ripening of—	82
,, Mechanical tillage of soil for—in Java	176
,, Mosaic disease of—in India	505
,, One-bud system of planting—	289
,, Root disease of—in Java	536
SUGARCANE GROWING. Pusa method of—	252

	PAGE
SUGARCANE SEEDLINGS. Mill trials of Coimbatore—	249
„ VARIETIES. Classification of—	60
„ „ Distribution of—in Java for the crop 1921-22..	177
SUPERPHOSPHATE. Effect of—on Bihar soils	152
„ Green-manuring with—	104, 230
SURRA	390
SWEDES. Trials with—at Pusa	422
SYMBIOTIC NITROGEN FIXATION IN NON-LEGUMINOUS PLANTS. K.	
Adinarayan Rao	132
T	
TAMARIND. Insect pests of—	55
TAYLOR, C. SOMERS. Note on some sugarcane juices received from Ranchi farm	410
„ C. SOMERS, AND GHOSH, MANMATHANATH. Experiments on the green-manuring of rice	104
„ J. K., AND LIPMAN, C. B. Power of wheat plant to fix atmospheric nitrogen	155
TECHNOLOGICAL RESEARCH ON RAW MATERIALS AND ITS RELATION TO PLANT BREEDING. B. C. Burt	
TEXTILE INSTITUTE. Journal of the—	95
THADANI, K. I. Linkage relations in cotton plant	572
THRESHING EXPERIMENTS AT LYALLPUR	614
TILLAGE IMPLEMENTS FOR INDIA	35, 647
TOMATOES. Effect of withholding nitrogen on yield of—	208
TRACTOR CULTIVATION AT LYALLPUR, PUNJAB. H. R. Stewart and D. P. Johnston	23
TRAINING. Post-graduate—in agriculture at Pusa	528
TREE-PIE, BENGAL	563
TREVASKIS, H. K. Some aspects of agricultural marketing	115
TUBERCULOSIS, BOVINE	394
TUBE-WELLS. Rôle of—in agricultural development	14
<i>Turdoides terricolor terricolor</i>	99
TURNIPS, SWEDES AND MANGOLD. Trials with—	422

U

UNITED PROVINCES. Cattle problem of the—	330
„ „ Poultry breeding in—	510, 512, 547
„ „ Trend of agricultural development in—	10

V

VARIETY TRIALS. Probable error in—	238, 475, 659
VENKATRAMAN, T. S. Is flowering a serious drawback in a new sugar-cane 538
" " " Propagating the sugarcane—success for Indian methods in Cuba 289
VETERINARY CONFERENCE AT CALCUTTA, SECOND 380
" EDUCATION IN INDIA 380
" LEGISLATION IN INDIA 398
VISWANATH, B., AND NORRIS, ROLAND V. <i>Sorghum</i> as a substitute for barley in malting operations 362
VITAMINS 77

W

WARTH, F. J. Digestion experiments with paddy straw 456
" " " Nitrogen metabolism stall for bullocks 267
WATER HYACINTH. Report of the Bengal—Committee 424
" REQUIREMENTS OF WHEAT 206
" SELF-RAISER 67
" SUPPLY. Importance of—in Indian agriculture 10
WEALTH AND WELFARE OF THE PUNJAB. H. Calvert. (Review) 272
WESTLY, E. T. Hawaiian sugar factory results for 1922 season 521
WHEAT. Effect of varying quantities of irrigation on—yield 206
WHEAT CROPS OF THE WORLD. James W. Wilson 173
" PLANT. Power of—to fix atmospheric nitrogen 155
" THRESHING AT LYALLPUR. Experiments on—. H. R. Stewart and D. P. Johnston 614
WILSDON, B. H., AND BARKAT ALI. Nitrogen fixation in arid climates 158
WILSON, J. W. World's wheat position 173
WILT OF COTTON 89
" " GRAM. Note on <i>Fusarium</i> —in Burma 608
" " INDIGO 211
" " POTATO 515
WORKING CLASS BUDGETS IN BOMBAY. Report on an enquiry into— G. Findlay Shirras. (Review) 558

Y

YARN. Testing of cotton--	89
YOUNGMAN, W., AND ROY, S. C. Pollination methods amongst lesser millets	580

Z

ZEMINDAR'S RÔLE IN AGRICULTURAL DEVELOPMENT	21
---	---------	----

Indian Agricultural Research Institute (Pusa)
LIBRARY, NEW DELHI-110012

This book can be issued on or before

Return Date	Return Date